

# ASSEMBLY INSTRUCTIONS

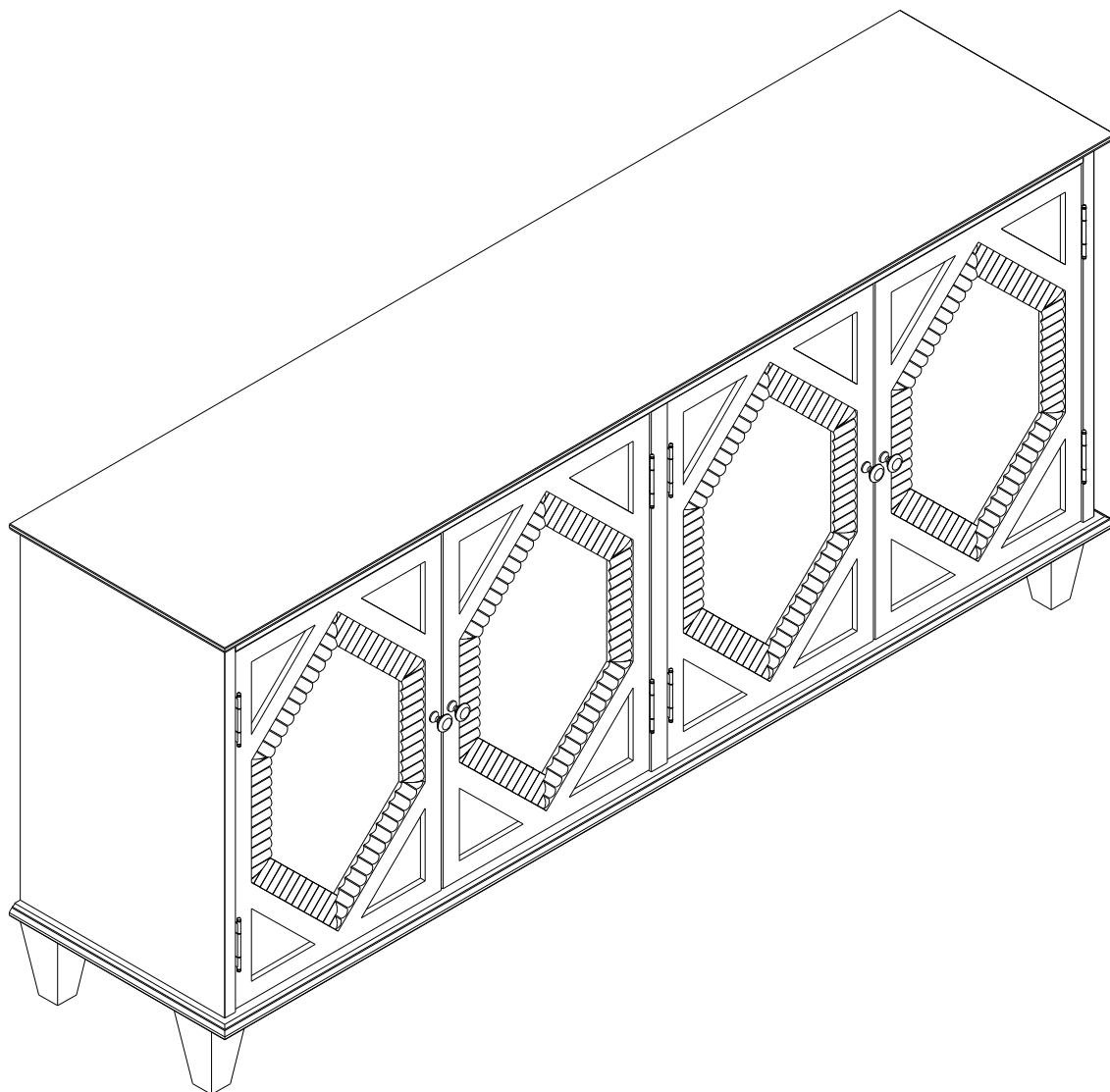

## Notice:

1. Follow the installation instructions. Please confirm all accessories are preset before installation.
2. Do not fully tighten the screws during initial assembly. Fully tighten screws only once all pieces which are correctly assembled.
3. If you encounter any problems during installation, please contact our customer service.
4. Please unbox the item from the side with an open-label and put a carpet on the floor to avoid scratching it.

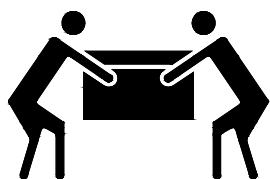

Recommended installers:2

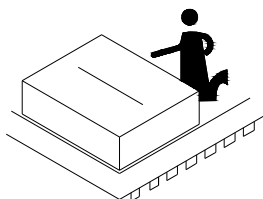

Put a carpet on the floor  
before unpacking

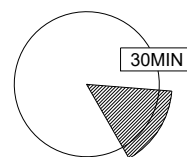

Estimate installation time:  
30minutes





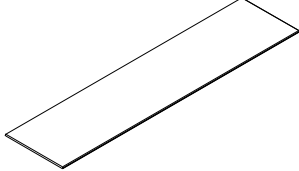
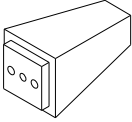
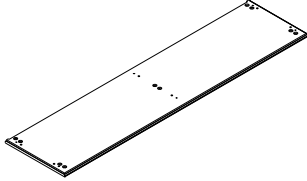
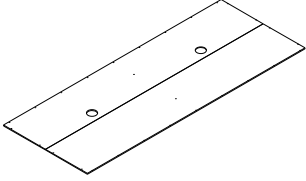
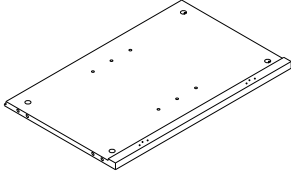
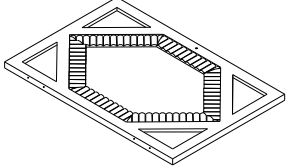
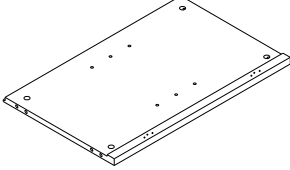
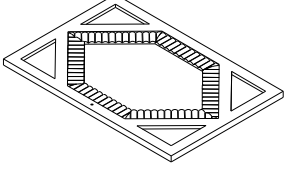
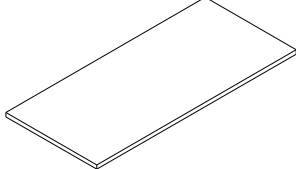
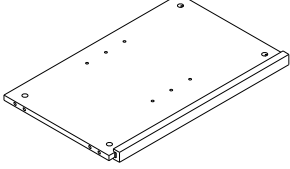



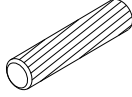
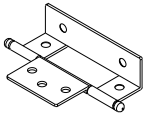
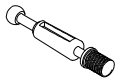

# ASSEMBLY INSTRUCTIONS

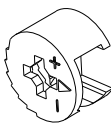
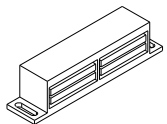
## PART LIST

| Item no. | Reference Image   | Qty | Item no. | Reference Image   | Qty |
|----------|---|-----|----------|---|-----|
| (A)      |    | X1  | (H)      |    | X5  |
| (B)      |    | X1  | (I)      |    | X1  |
| (C)      |   | X1  | (J)      |   | X2  |
| (D)      |  | X1  | (K)      |  | X2  |
| (E)      |  | X2  | (L)      |  | X1  |
|          |   |     |          |   |     |
|          |   |     |          |   |     |
|          |   |     |          |   |     |

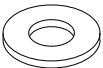
# ASSEMBLY INSTRUCTIONS

## HARDWARE LIST

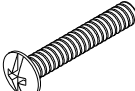
| Item no. | Reference Image  | Qty   | Item no. | Reference Image  | Qty   |
|----------|--|-------|----------|--|-------|
| 1        | <br>Ø8*30mm         | X17+1 | 9        |               | X8    |
| 2        |                     | X12+1 | 10       | <br>Ø3*15mm   | X56+5 |
| 3        |                     | X12+1 | 11       |               | X2    |
| 4        | <br>Ø1/4"*1"-1/4" | X10+1 | 12       | <br>Ø3*15mm | X30+3 |
| 5        |                   | X10+1 | 13       |             | X8    |
| 6        |                   | X10+1 | 14       |             | X1    |
| 7        |                   | X4    | 15       |             | X2    |
| 8        | <br>Ø5*32"*1"     | X4    |          |  |       |
|          |  |       |          |  |       |
|          |  |       |          |  |       |

# ASSEMBLY INSTRUCTIONS

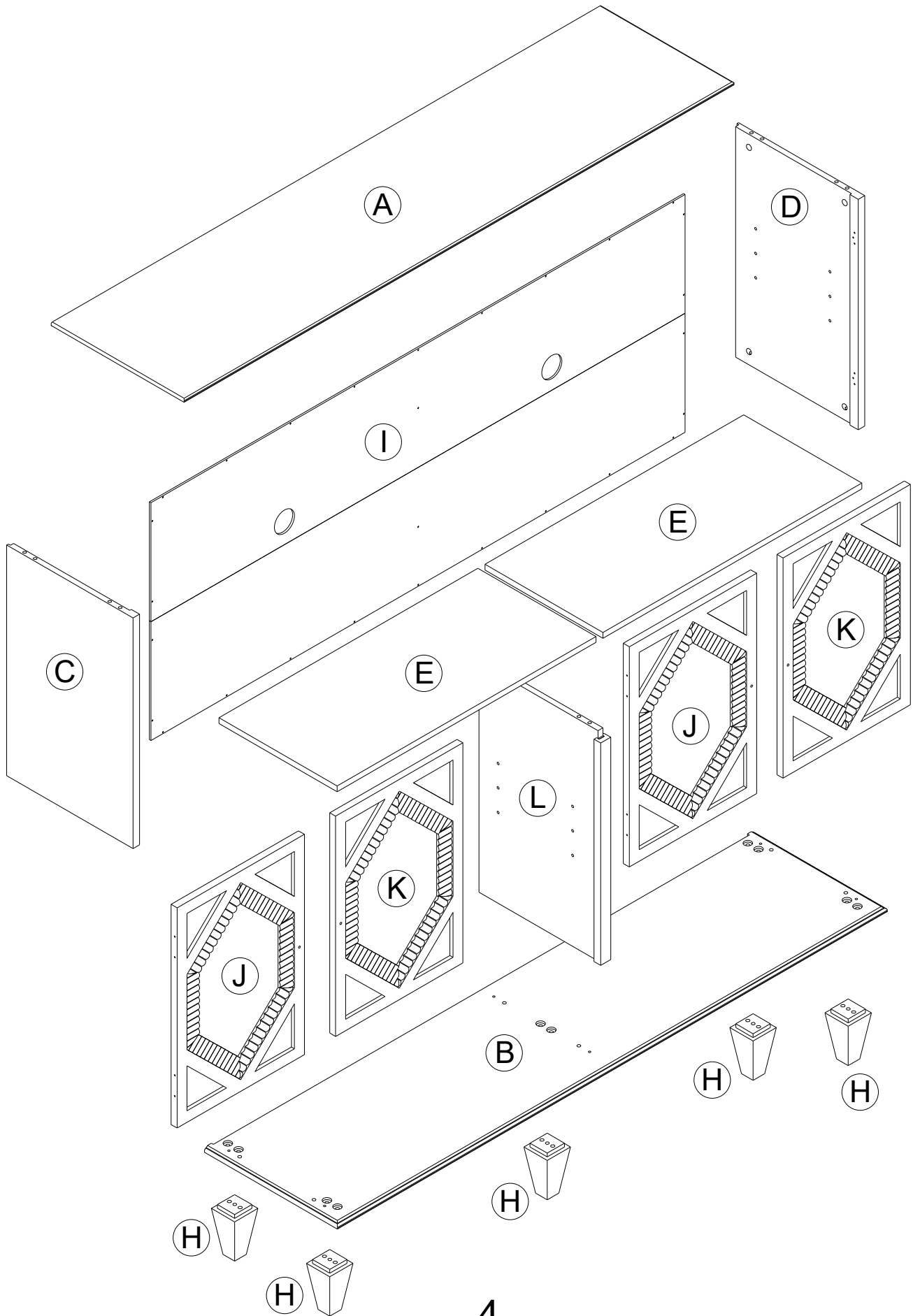

# ASSEMBLY INSTRUCTIONS

1

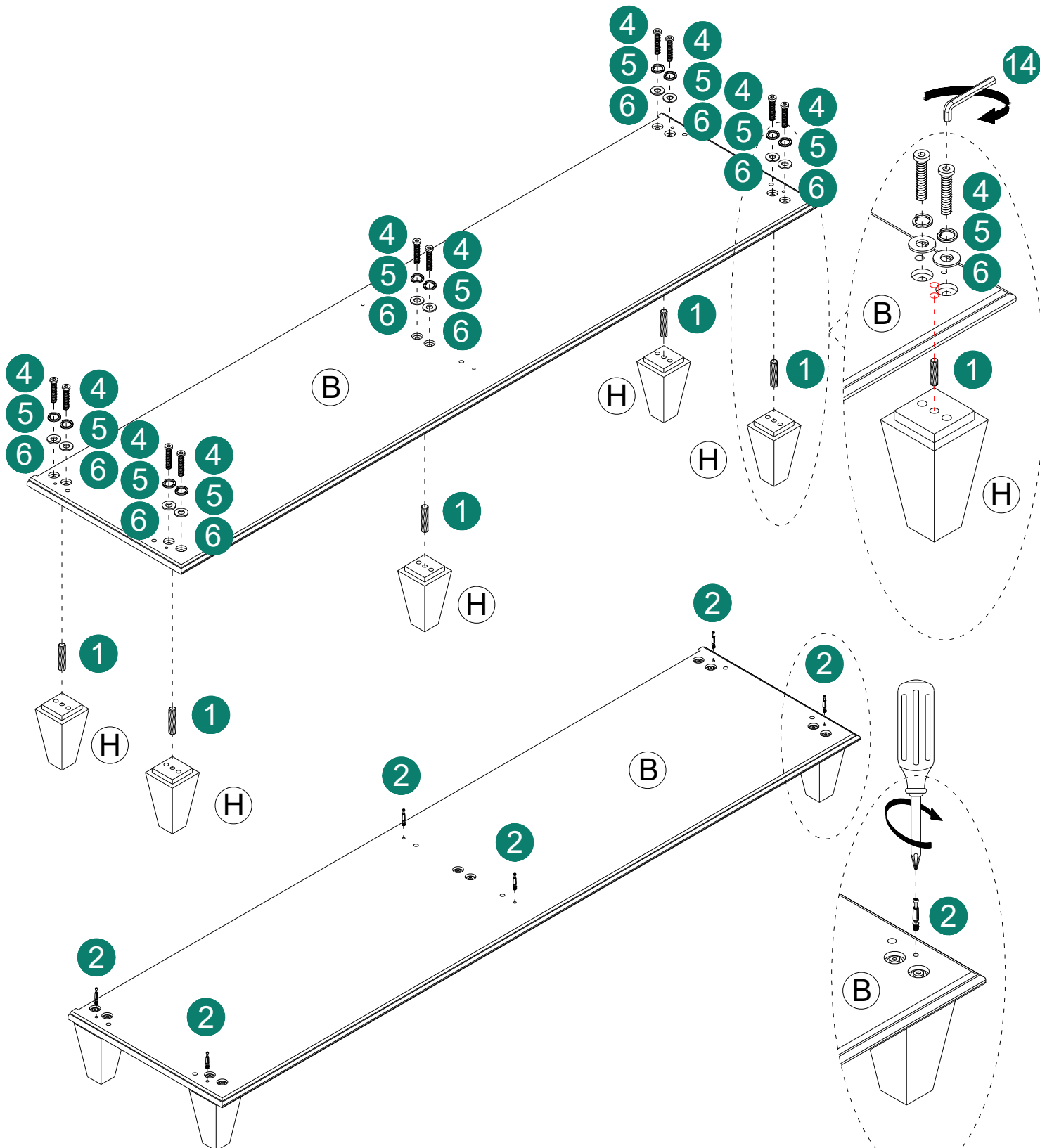
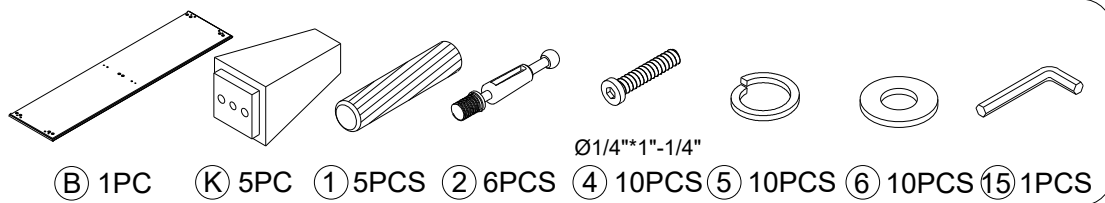

# ASSEMBLY INSTRUCTIONS

2

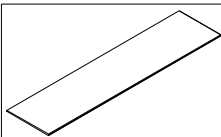

(A) 1PC

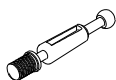

(2) 6PCS

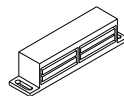

(11) 2PCS



Ø3\*15mm

(12) 4PCS

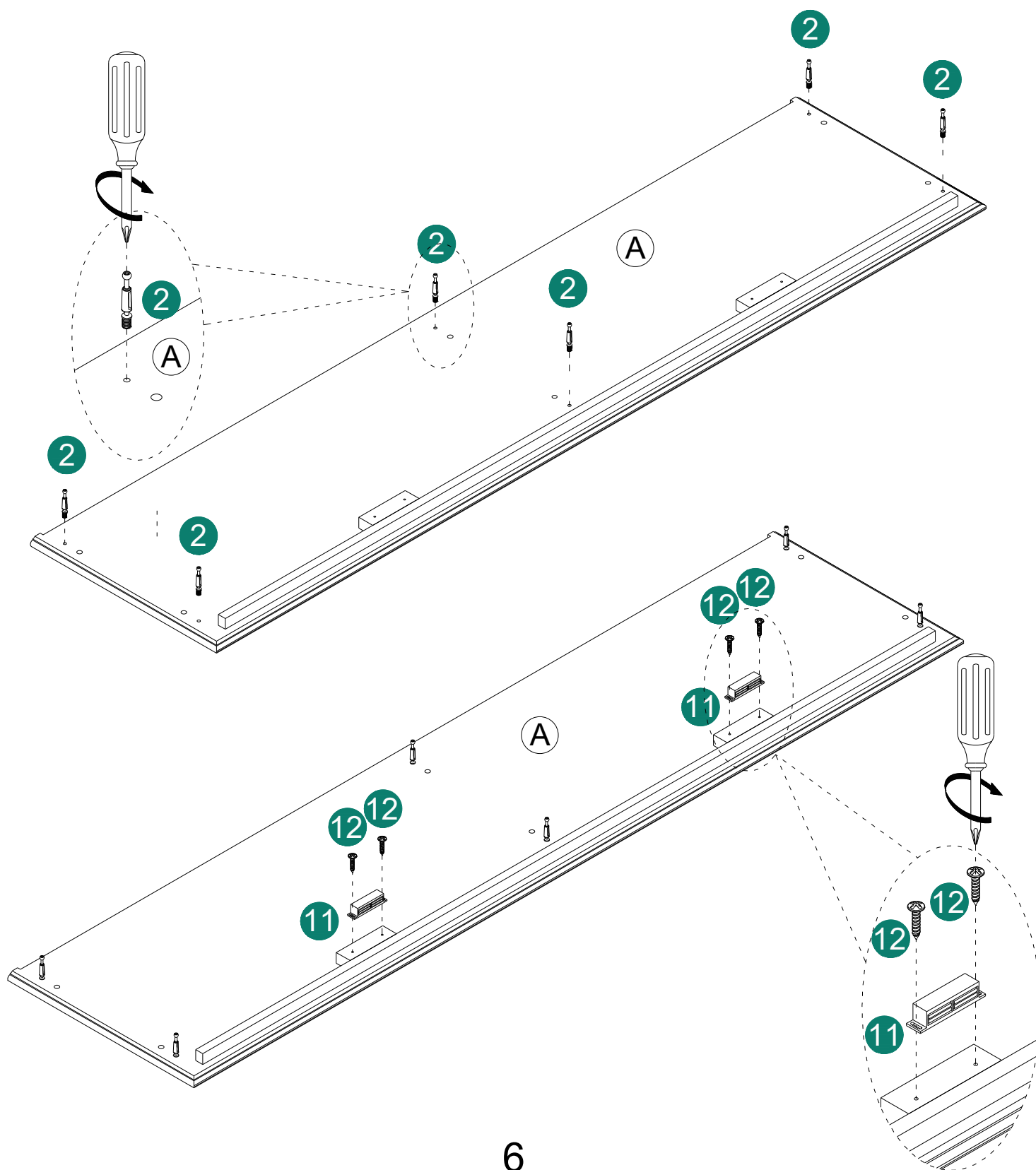

# ASSEMBLY INSTRUCTIONS

3

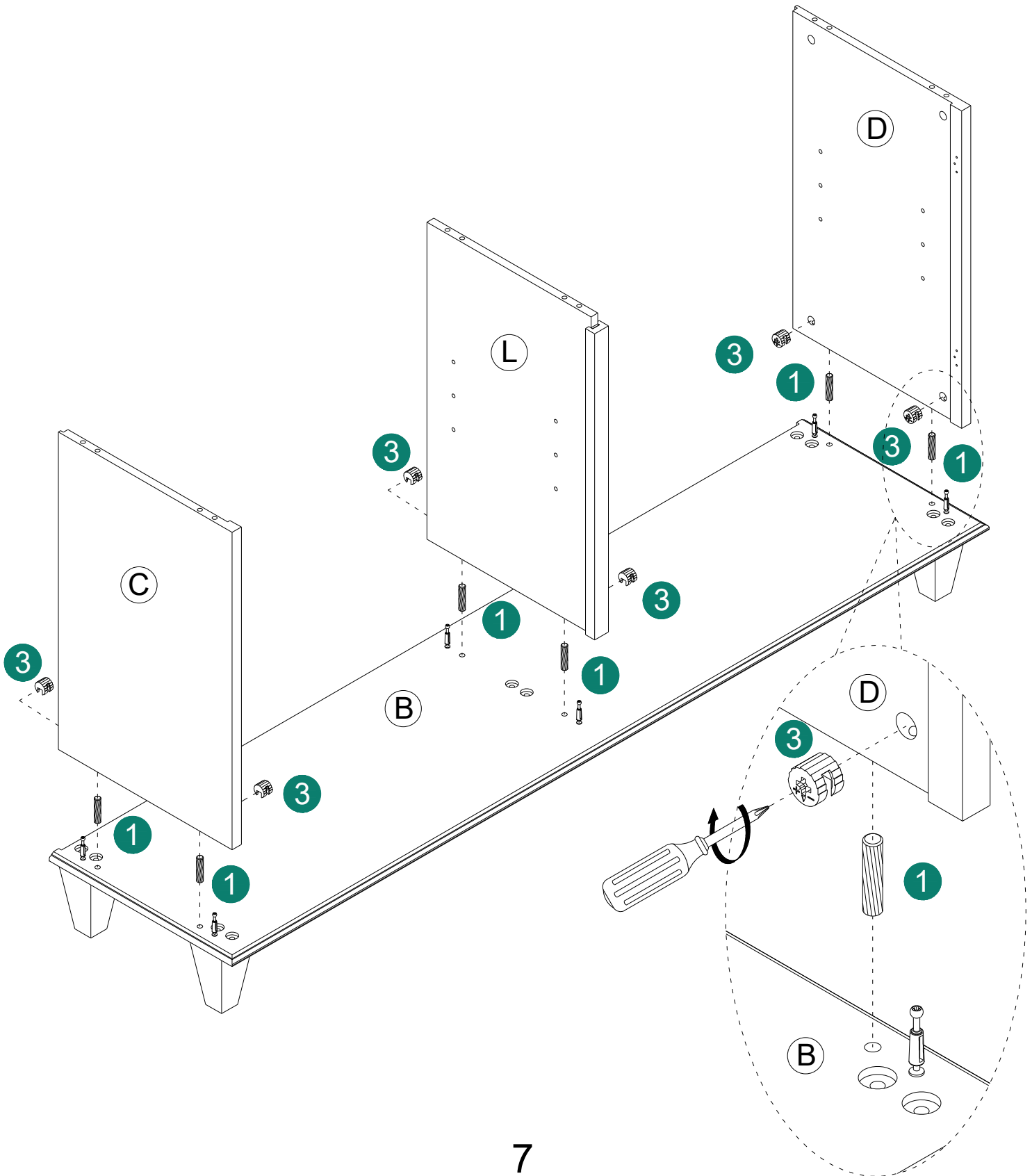
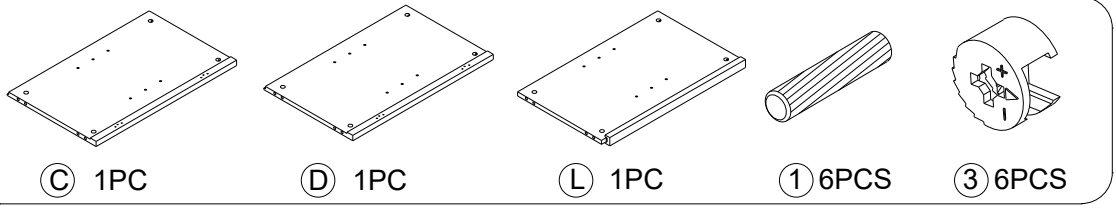



# ASSEMBLY INSTRUCTIONS

5

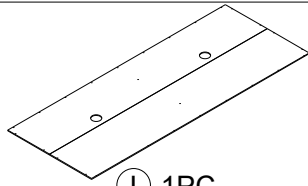

① 1PC



Ø3\*15mm

⑫ 26PCS

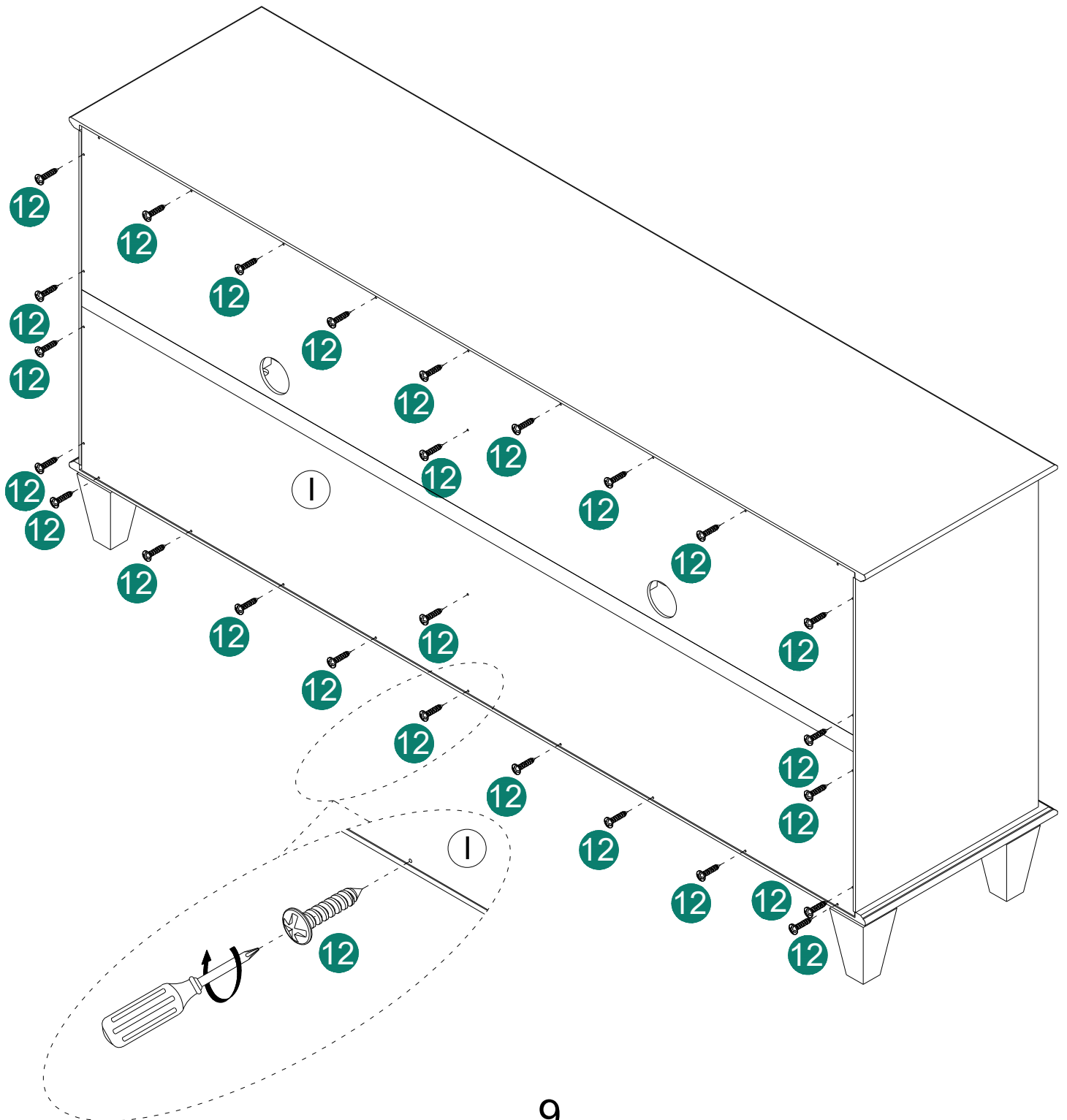

# ASSEMBLY INSTRUCTIONS

6

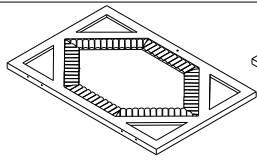

ⓐ 2PC

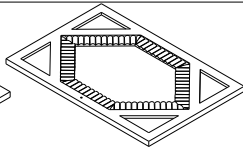

ⓑ 2PC

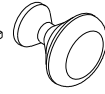

Ⓒ 4PC

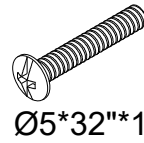

Ø5\*32\*1"

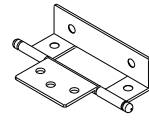

Ⓓ 8PC



Ø3\*15mm

ⓓ 32PC

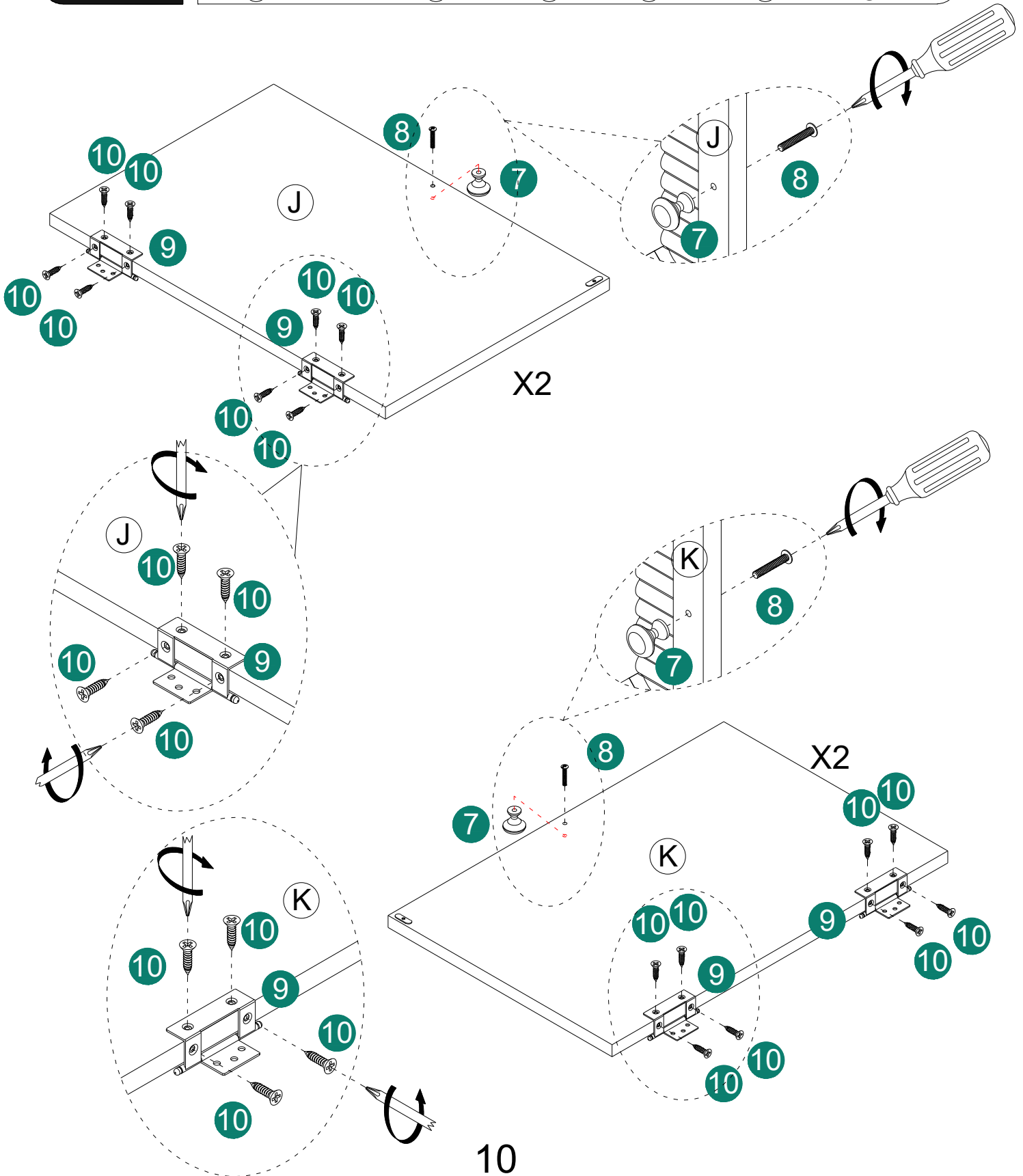

# ASSEMBLY INSTRUCTIONS

7

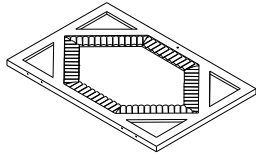

J 2PC

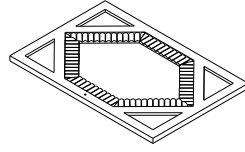

K 2PC



Ø3\*15mm

10 24PC

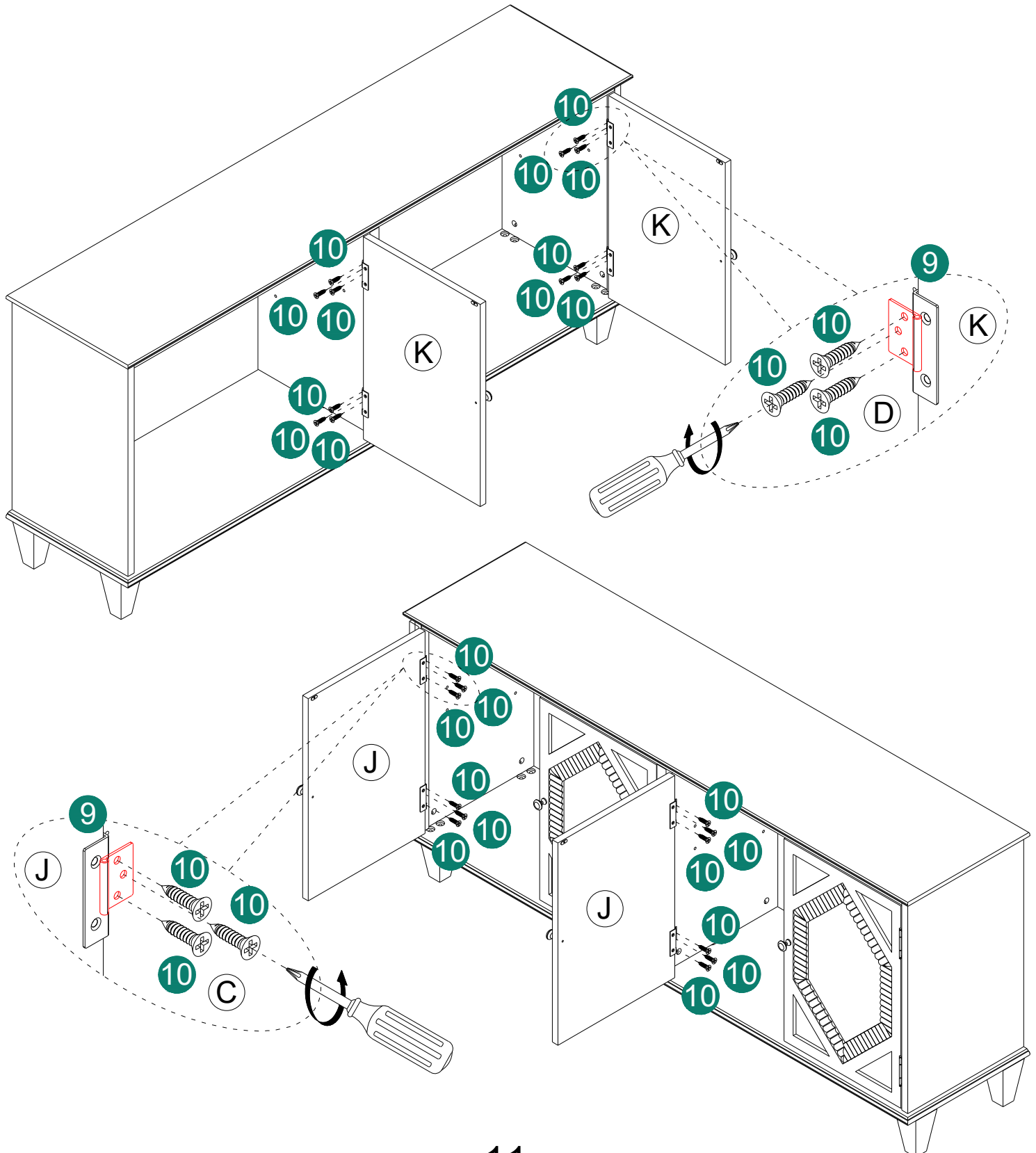

# ASSEMBLY INSTRUCTIONS

8

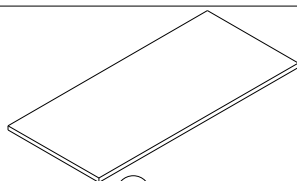

E 2PC



13 8PC

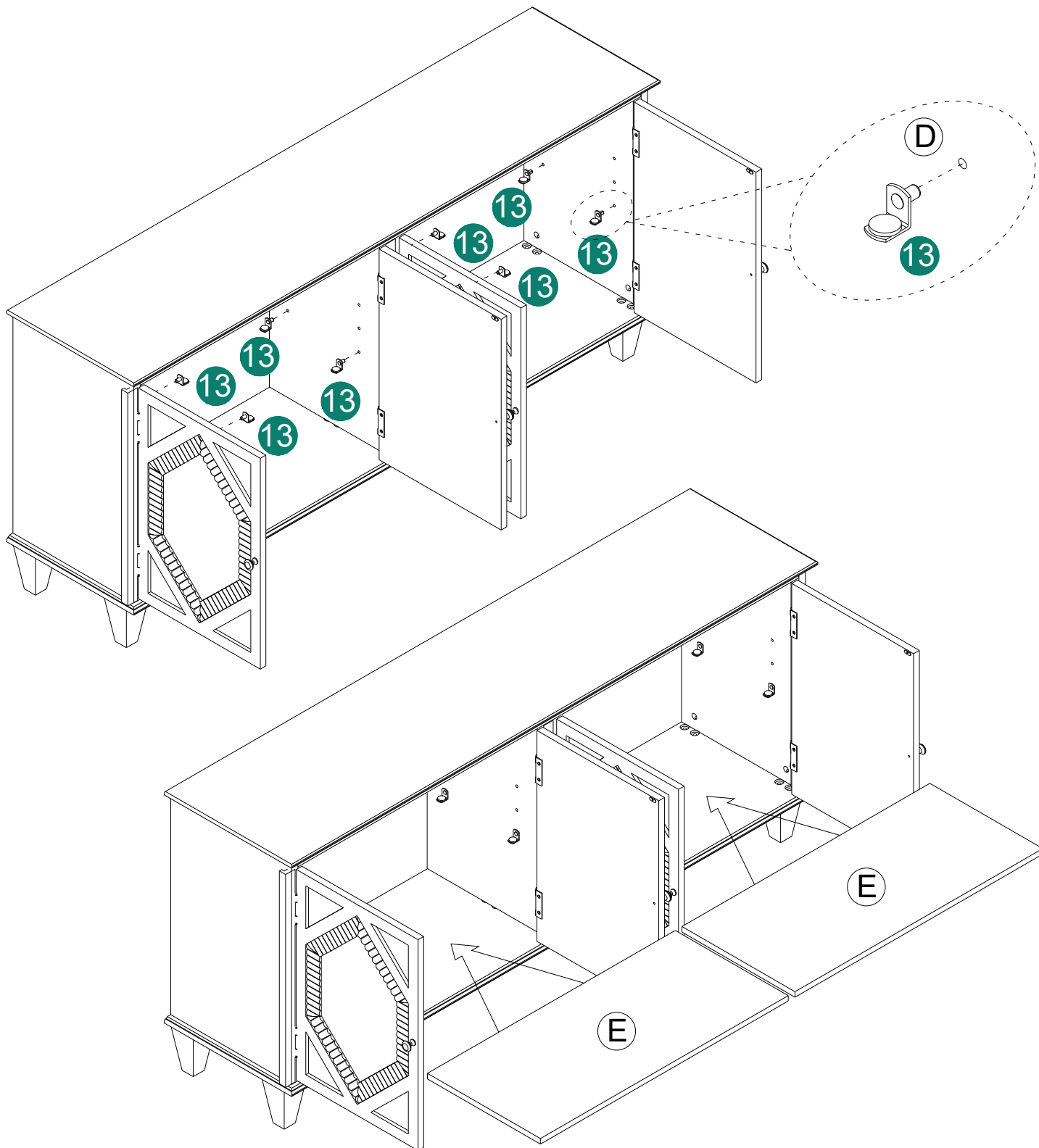

# ASSEMBLY INSTRUCTIONS

9

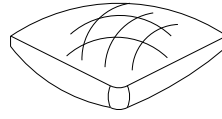

15 2set

A

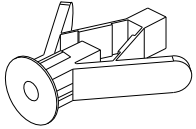

2pcs

B

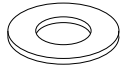

4pcs

C

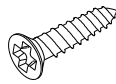

Ø8\*3/4"  
2pcs

D

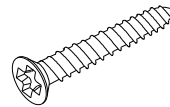

Ø8\*1-1/2"  
2pcs

E

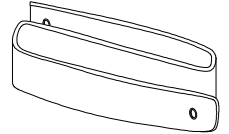

2pcs

WALL

