

INSTALLATION INSTRUCTIONS

PARTS LIST

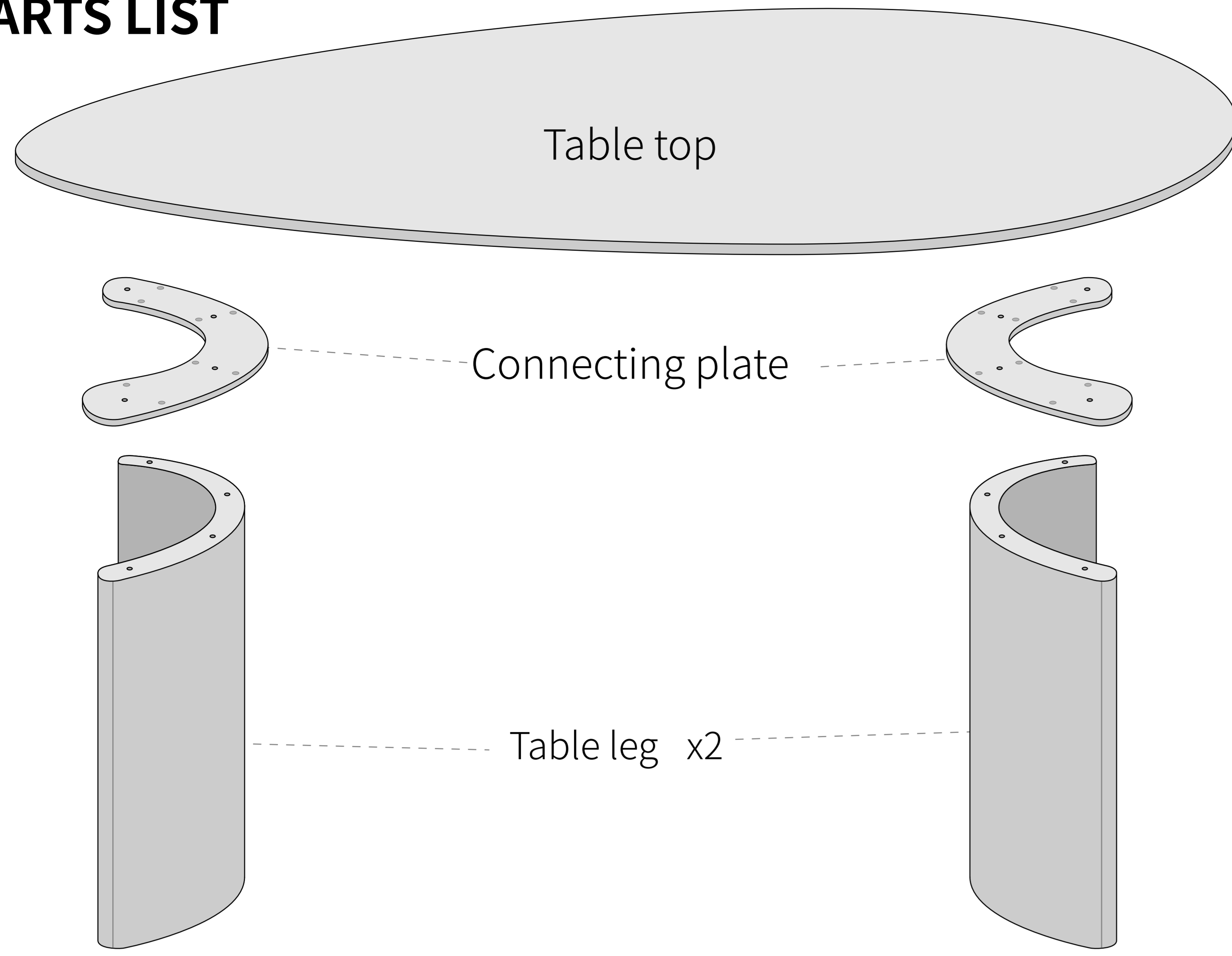

The extra parts are for spare

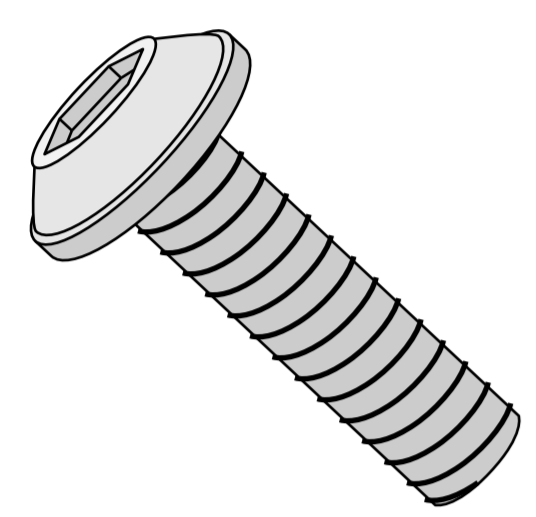

Screw (2) x16

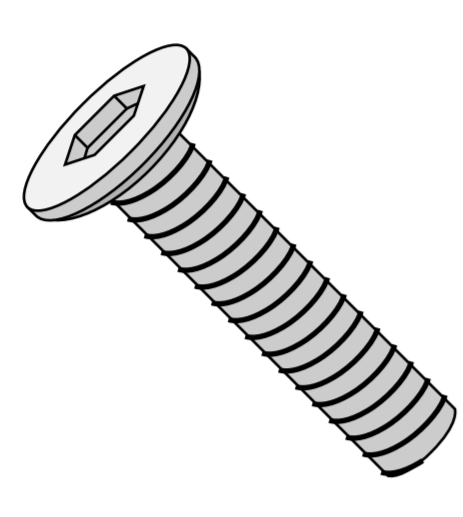

Screw (1) x8

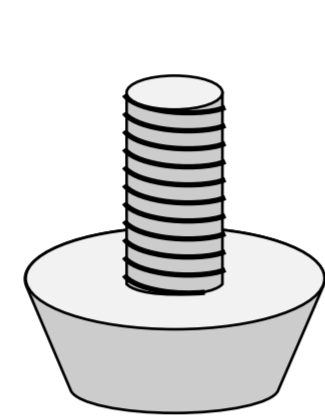

Adjustable foot pads x5

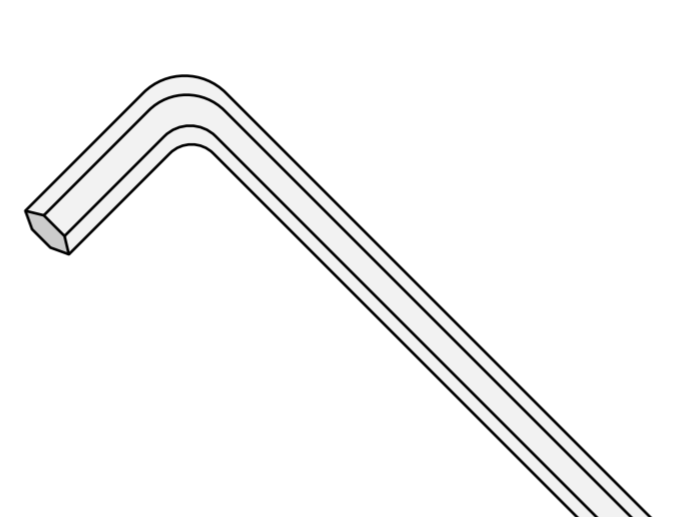

Hex key

MARBLE CLEANING. MAINTENANCE. PRECAUTIONS

· REGULAR CLEANING:

The marble should be cleaned with special cleaning agents to avoid damaging the surface structure. In general, a neutral cleaner, such as alcohol or warm water, should be used and then wiped with a clean cloth to maximize the cleaning of the surface

· DECONTAMINATION:

To remove dirt on the marble, you can use a one-time wet, and then rinse it off with water. If there is oil, you can use dish soap, but be careful not to use too much, so as not to break the internal structure of the marble.

· MAINTENANCE:

The marble should be regularly maintained with paraffin wax to increase the surface light, and to effectively protect the surface from pollution erosion. In addition, it is also important to polish the marble regularly to maintain the finish and water resistance.

· NOTE:

When cleaning, note: do not use detergent containing acid components, do not use metal or other hard objects to clean the marble, so as not to wear the surface.

STEP 1

Remove the screws (2) from the connecting plate on the back of the table and remove the two connecting plates

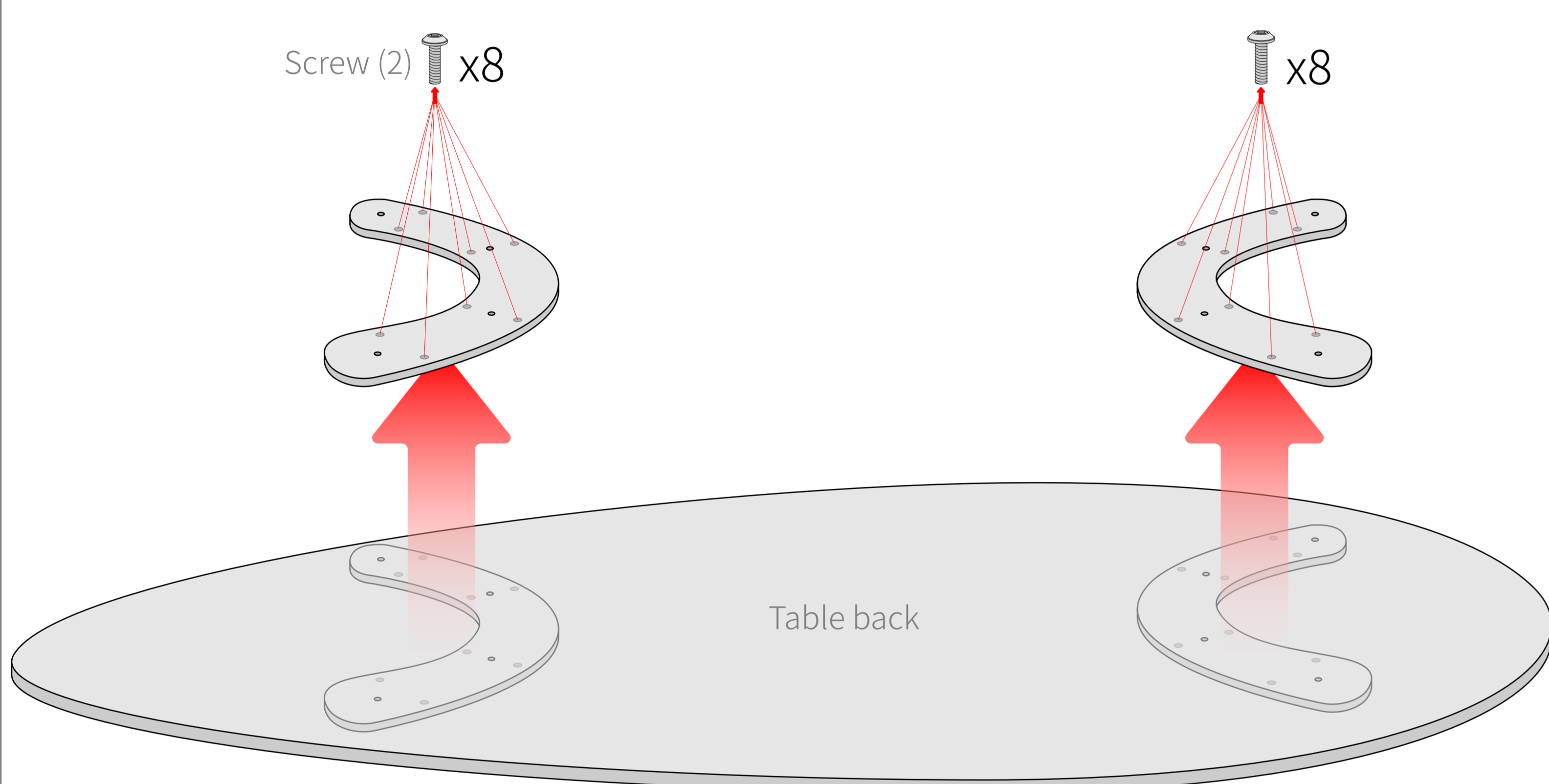

STEP 2

Align the connecting plate to the screw hole above the table legs

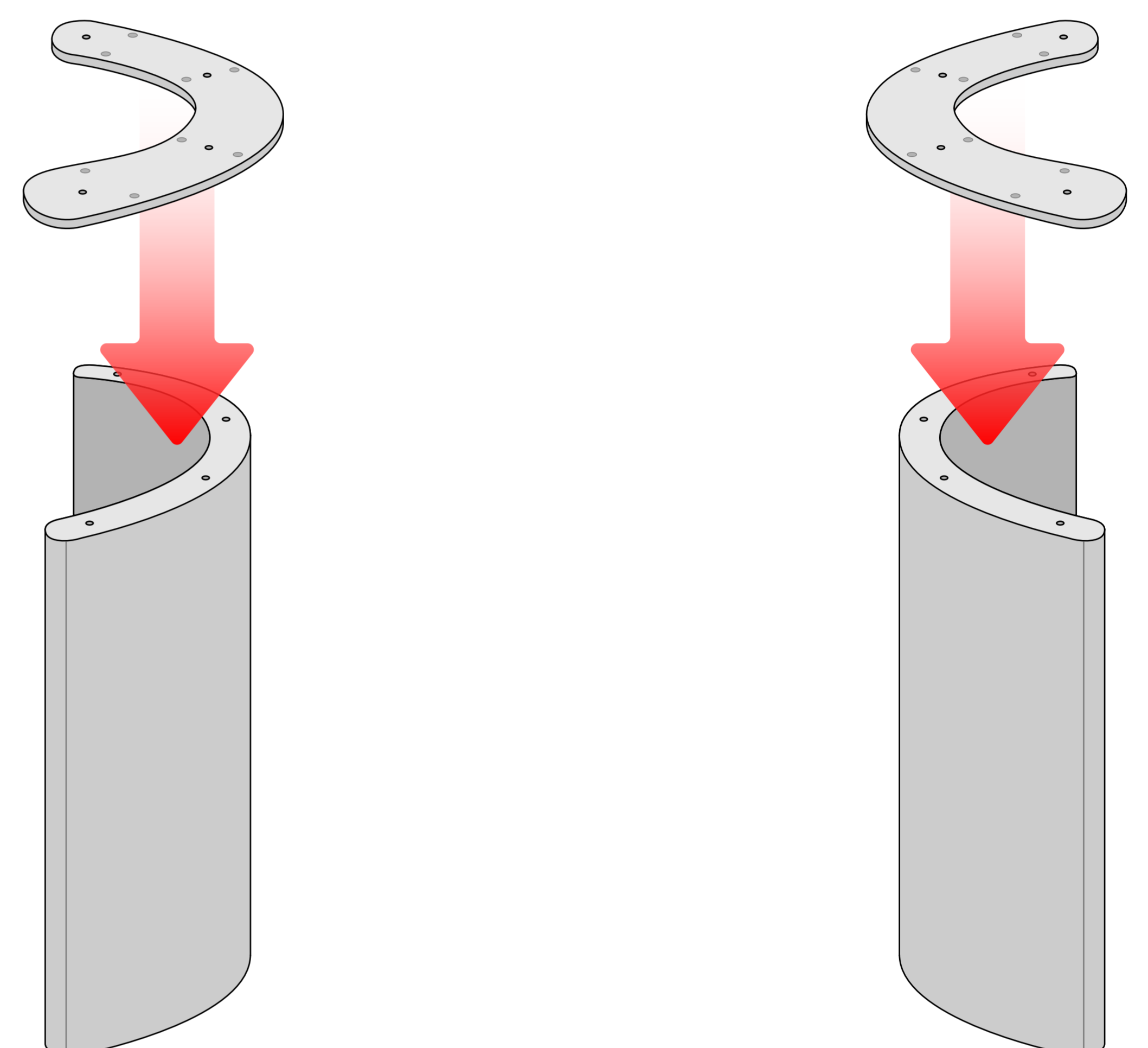

STEP 3

Secure the connecting plate to the table leg with screw (1)

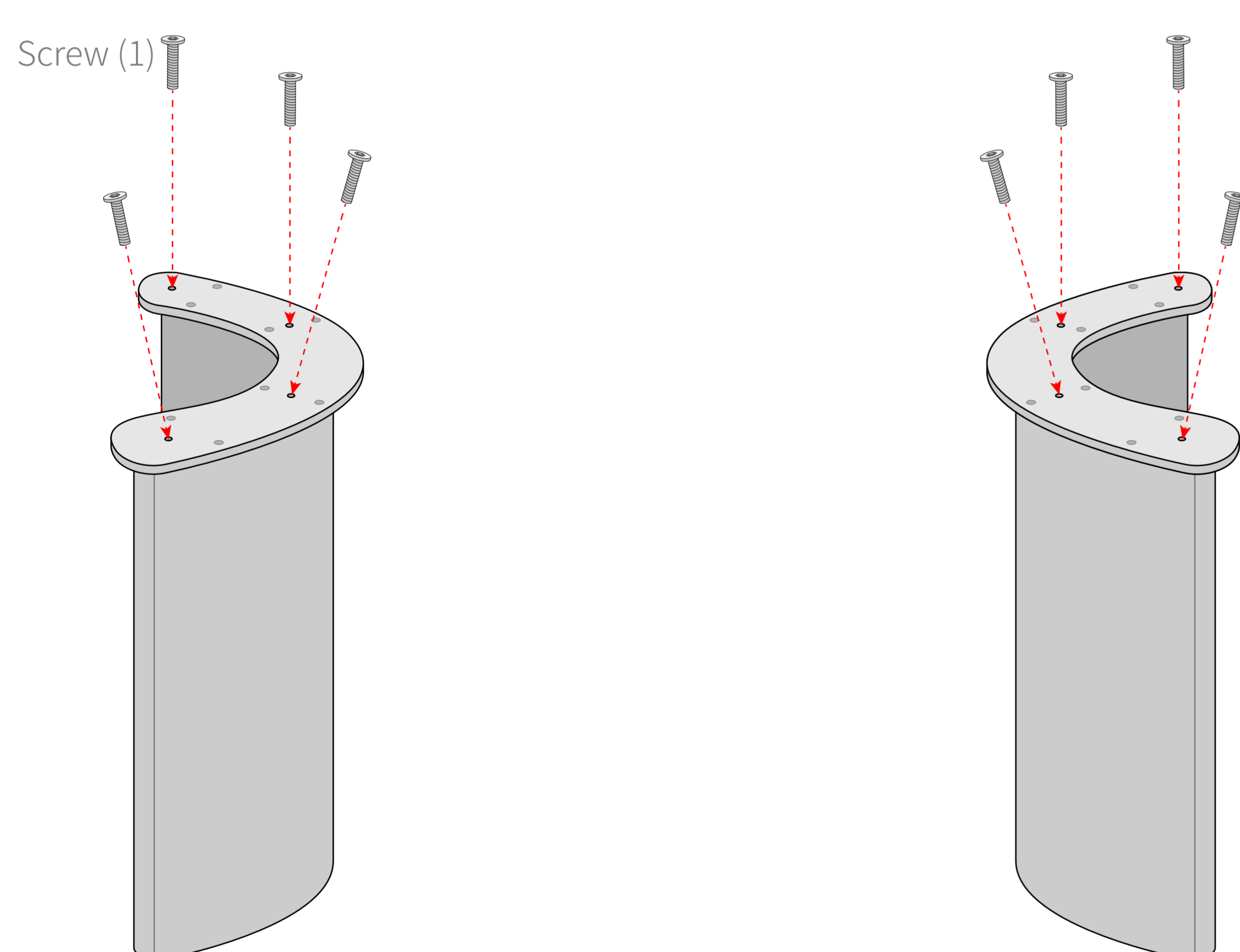

STEP 4

Turn the legs upside down on the back of the table

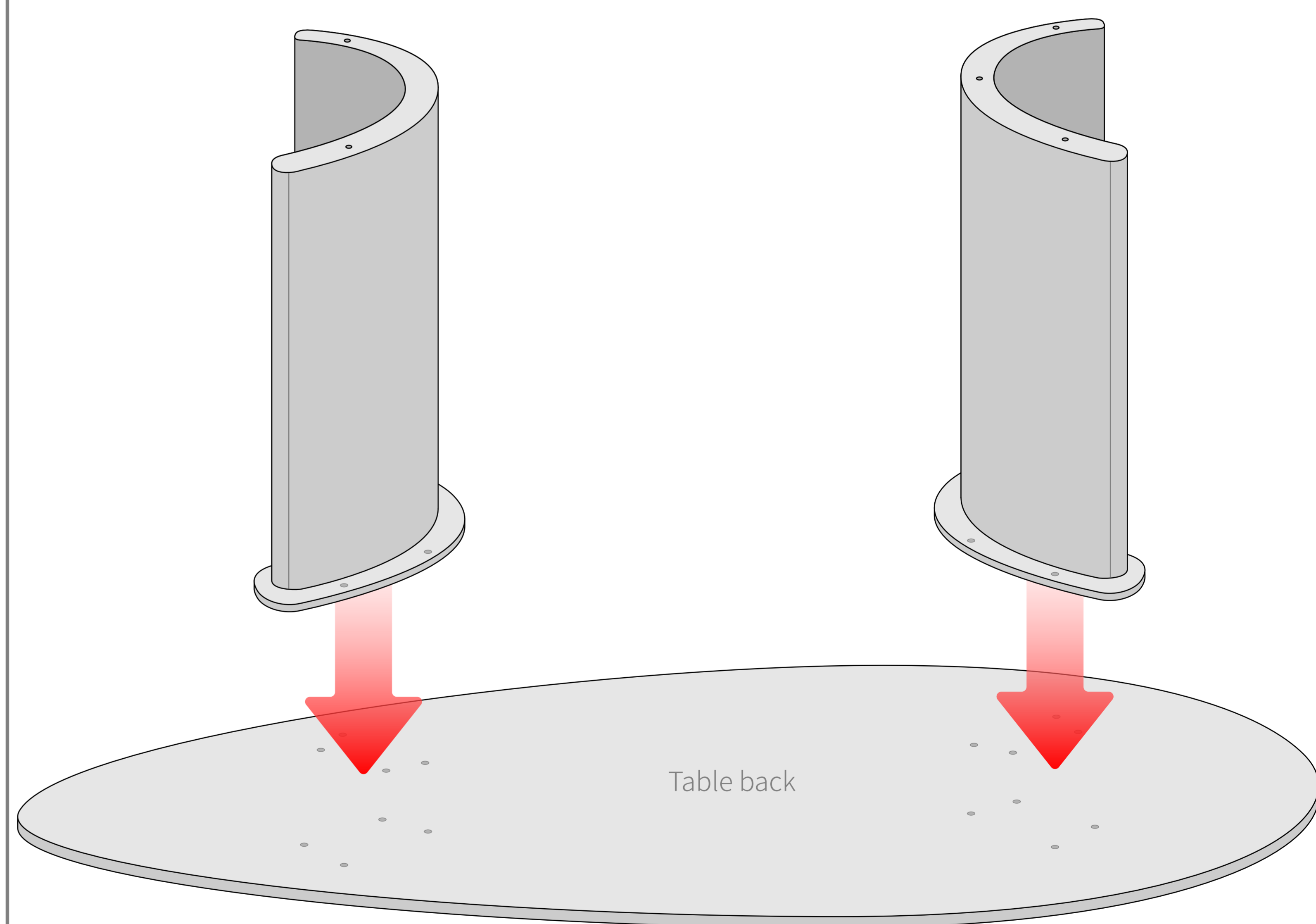

STEP 5

Fix the connecting plate with screw(2) and install adjustable foot pads at the bottom of the table legs

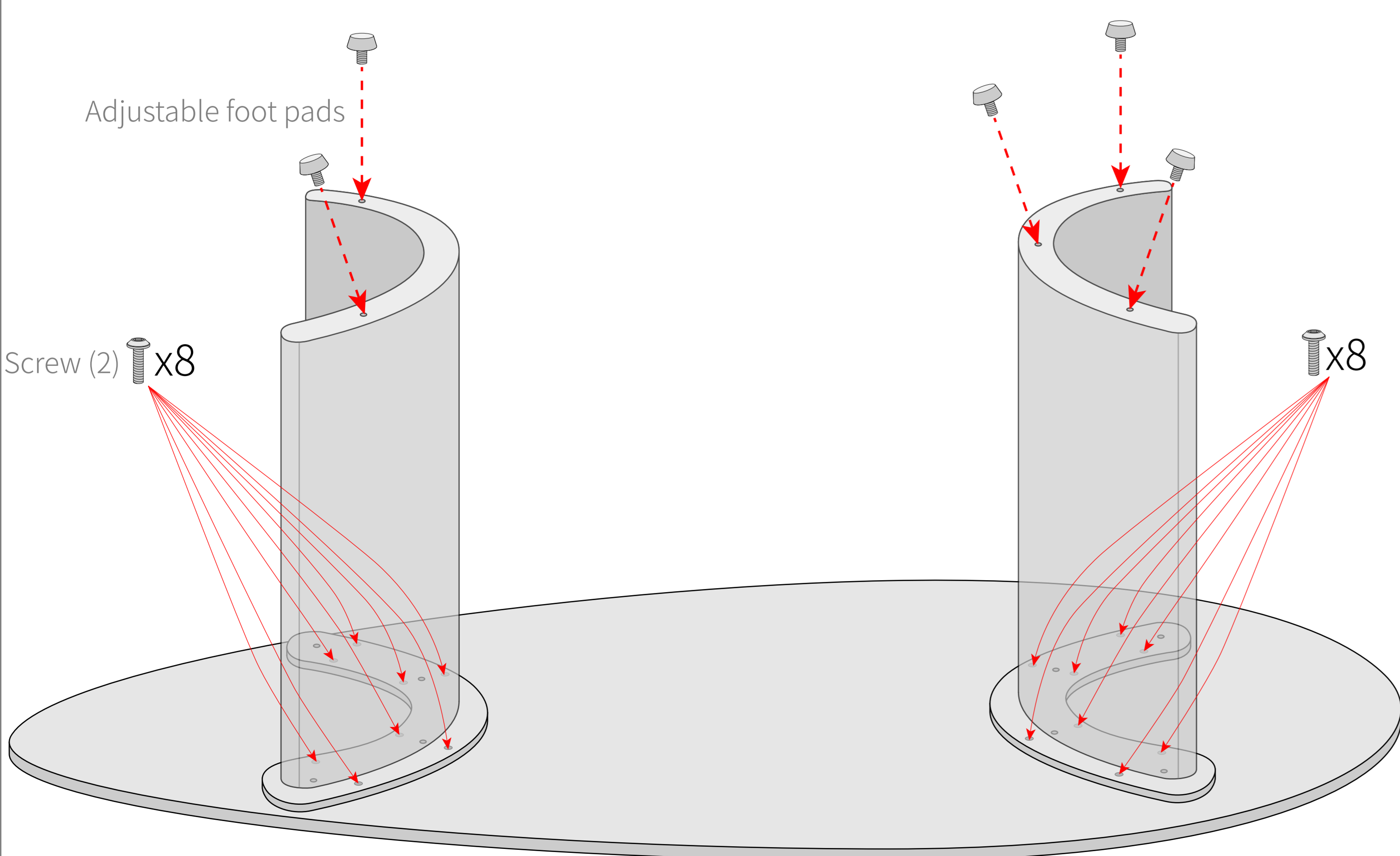

INSTALLATION COMPLETE

