

SALAV

USER MANUAL

Please read all instructions
carefully before using
this product.

Garment Steamer

Model: GS34-BJ



www.salavusa.com

Dear Valued Customer

Thank you for purchasing this SALAV product. Please read this manual prior to using your SALAV appliance. For more product information, FAQ and customer support please visit our website at www.salavusa.com.

Important Safety Instructions:

1. The voltage of your electrical source must correspond to that of the appliance(110-120V~60Hz). Connecting to the incorrect voltage may cause unrepairable damage to the appliance and will invalidate the warranty.
2. Do not share the power supply with other high-powered electric appliances.
3. To reduce the risk of electric shock, do not immerse the appliance, plug, or power cord in water or other liquids.
4. Do not leave this appliance unattended while it is in operation.
5. Fill in water before using and observe the water level during use.
6. Do not lay hose on the ground. Do not wind hose. Do not operate the appliance if cord is damaged.
7. Always keep the hose and nozzle elevated above the water tank. Never insert any object into any opening or hose.
8. Do not cut or attempt to extend the steam hose or power cord.
9. Do not place the nozzle directly on any surface or the appliance power cord while it is hot or plugged in.
10. Be cautious about steam spraying out from the nozzle. Do not direct steam at people or animals, or use steamer on garments while they are being worn.
11. Steam only in a vertical motion. Never use steamer in a horizontal position or tilt backwards - doing so may result in hot water discharge.
12. Move the appliance by firmly grasping the pole. Drain the water tank and water reservoir before moving.
13. Turn off, unplug and allow the appliance to cool completely for at least 30 minutes prior to draining the water tank and water reservoir and storing.
14. Always turn off and unplug unit before refilling, draining, cleaning, moving, or when not in use.
15. For indoor use only.
16. Keep the appliance away from flammable materials and chemicals.
17. Do not fill the water tank with hot water or corrosive cleaning agents which could cause damage. Distilled or filtered water is strongly recommended.
18. When in use, this appliance will spray hot steam from its steam nozzle. To avoid injury from hot steam, do not aim the steam nozzle at people or pets.
19. Only use SALAV accessories on your SALAV appliance. The use of accessory attachments other than those provided by SALAV may result in fire, electric shock or irreversible damage to the appliance.
20. This appliance is not intended for use by children or near children and other persons whose physical, sensory or mental capabilities or lack of experience and knowledge prevents them from using the appliance safely without supervision or instruction by a responsible person to ensure that they can use the appliance safely.

COMPONENTS

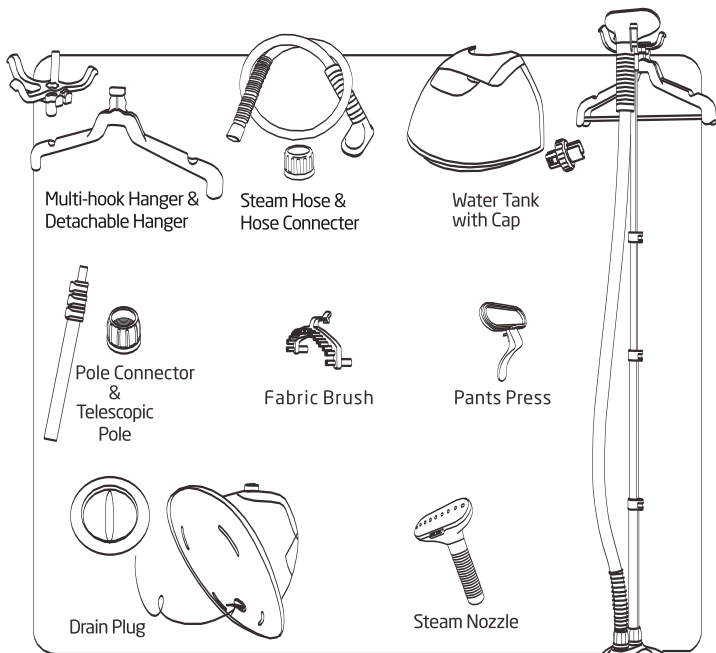

PRODUCT SPECIFICATION

Model	GS34-BJ
Water Tank Capacity	1.0L
Steam Output Time	45 seconds
Input Voltage	110 - 120V~60Hz
Output Power	1260 - 1500W

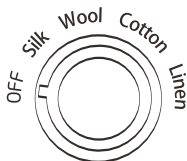

4 steam settings for various fabric types

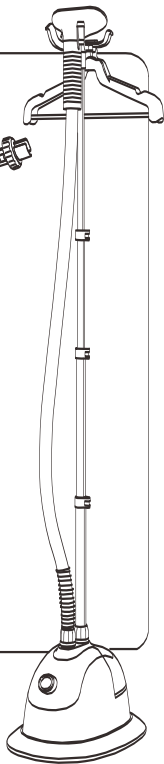

SETTING UP YOUR GARMENT STEAMER

STEP 1

Insert the Telescopic Pole and tighten the Pole Connector.

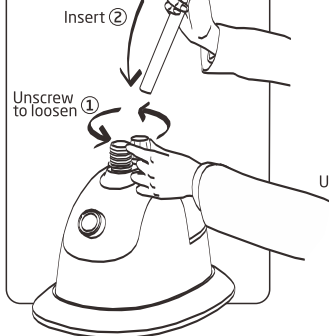

STEP 2

Attach the Multi-Hook Hanger to the top of the Telescopic Pole and push down until it is clicked in place. Extend the Telescopic Pole to desired height and lock in place.

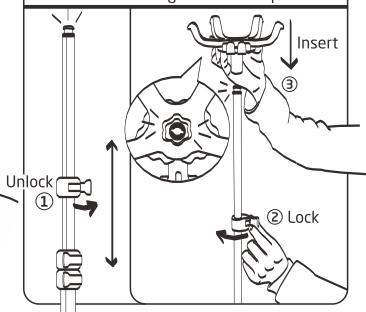

STEP 3

Install the Steam Hose and tighten the Hose Connector.

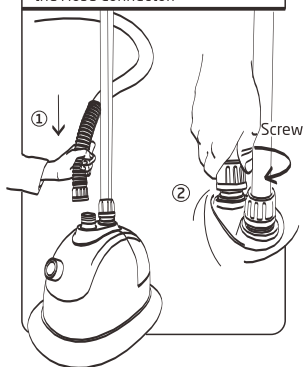

STEP 4

Insert the top of the Hanger into the Multi-hook Hanger notch. Hang the Steam nozzle onto the Multi-hook Hanger.

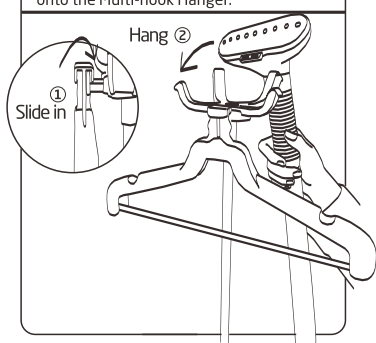

INSTRUCTIONS FOR USE

STEP 1

Remove the Cap. Fill the Water Tank. Replace & tighten the Cap.

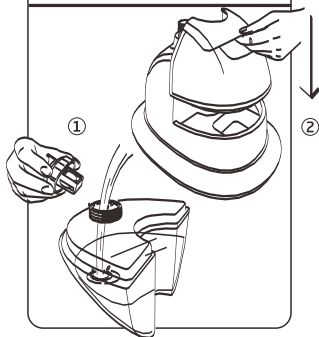

STEP 2

Plug in & Turn on.

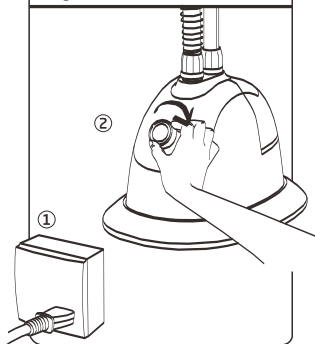

STEP 3

Wait for steam to heat up between 45-80 seconds depending on steam setting.

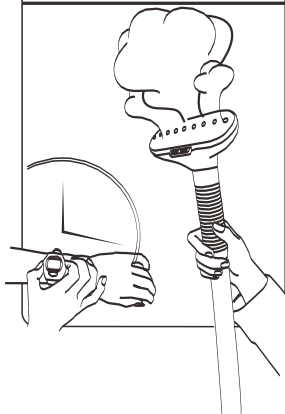

STEP 4

Ready for steaming.



MAINTENANCE AND CLEANING

STEP 1

Turn off the unit and unplug it. Wait at least 30mins until the unit cools down completely.

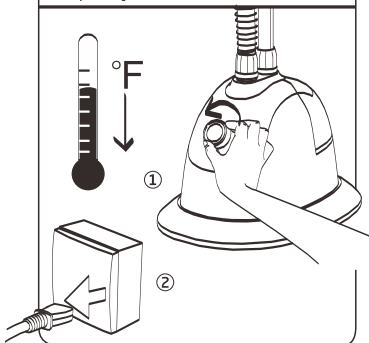

STEP 2

Collapse and remove the Telescopic Pole & Steam Nozzle. Remove the Water Tank and set aside. Carefully turn unit over to unscrew the drain plug.

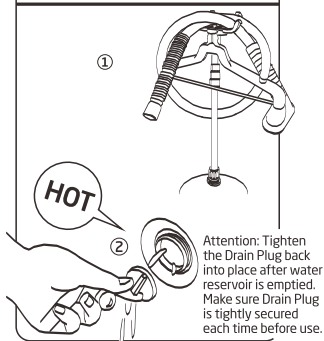

REMOVING MINERAL BUILD-UP

STEP 1

Turn off and unplug the unit and cool for at least 30mins. Remove water tank. Mix water & vinegar solution and pour into water reservoir.

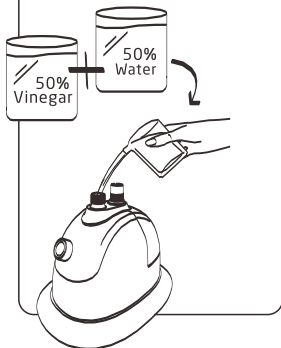

STEP 2

Wait for 40mins, unscrew the Drain Plug and drain the water reservoir. Pour clean water into reservoir and let it drain. After the reservoir is empty, replace and tighten the Drain Plug.

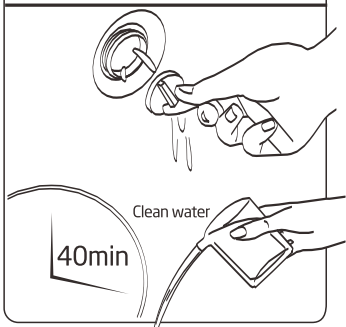

ACCESSORIES ASSEMBLY AND USE

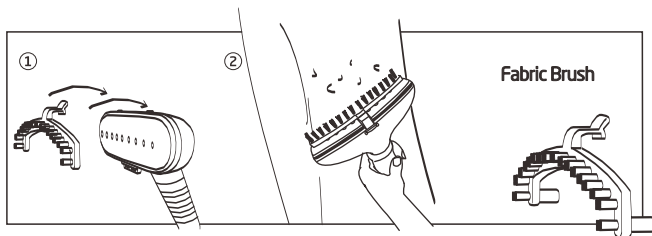
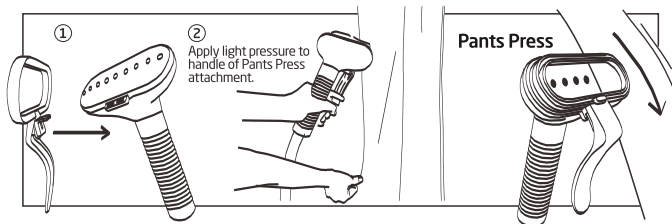
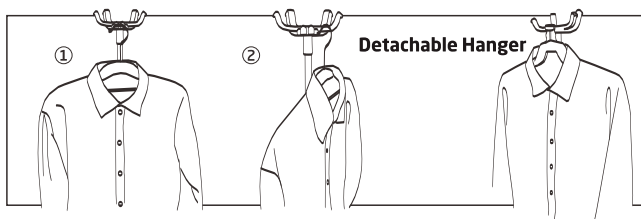
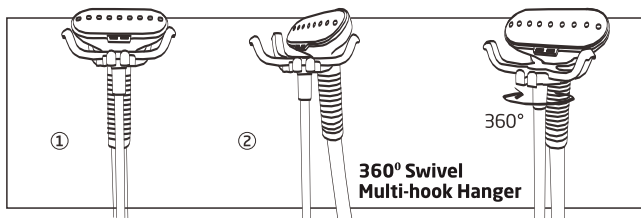







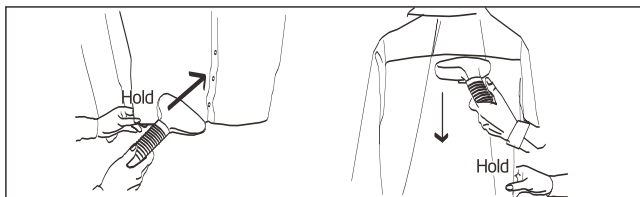
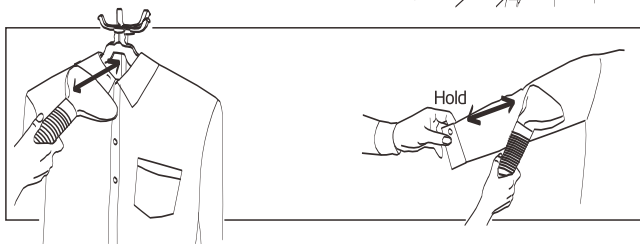
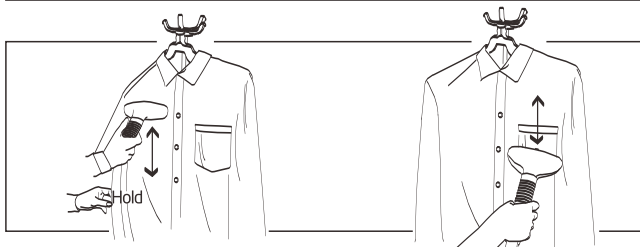
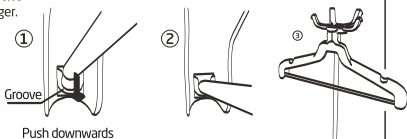



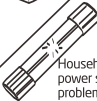
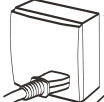

How to Steam

Hanger Bar & Detachable Hanger

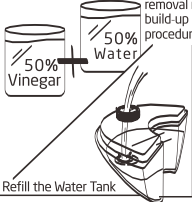
Install both sides of the Hanger Bar into the two grooves on the ends of the Detachable Hanger.

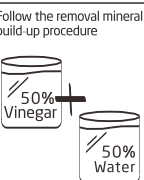

TROUBLE SHOOTING

Problems	Reason	Solution
<p>Unit fails to steam. Indicating lamp does not illuminate</p> 	<p>The unit is not plugged in</p>  <p>Household power system problem /fuse is blown.</p> 	<p>Plug in the unit</p>   <p>Call a qualified electrician for help.</p>
<p>Unit fails to steam Indicating lamp illuminates</p> 	<p>Mineral build-up</p>  <p>Water Tank is empty</p> 	<p>Follow the removal mineral build-up procedure.</p>  <p>50% Vinegar + 50% Water</p> <p>Refill the Water Tank</p>
<p>Noise in Steam Hose. Steam hose stops spraying steam</p> 	<p>Water drops gather in the Steam Hose</p> 	 <p>Straighten the Steam Hose</p>
<p>Steam is intermittent</p> 	<p>Mineral build-up in Water Tank</p> 	<p>Follow the removal mineral build-up procedure</p>  <p>50% Vinegar + 50% Water</p>

Visit our website to find product tips, customer support and learn about
SALAV patented steam technology.
www.salavusa.com

