

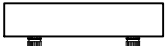







<p>① canopy 1PCS</p>  <p>② cap nut 2PCS</p> 	<p>③ lock nut and teeth lock washer</p>  <p>④ hanging tube 1PCS</p> 	<p>⑤ hanging tube 1PCS</p> 	<p> X 1PCS</p> <p> X 3PCS</p> <p> X 3PCS</p> <p> X 3PCS</p> <p> X 3PCS</p>
<p>⑥ light fixture 1PCS</p> 	<p>⑦ lampshade 1PCS</p> 		

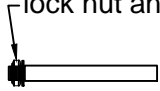
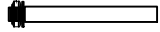
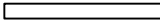

1. Let the wire of the light fixture ⑥ go through the hanging tube ⑤, rotate to fix the tube ⑤ to the fixture.

2. Rotate to install the lampshade ⑦ to the fixture.

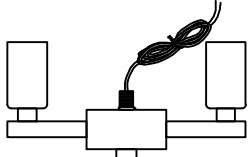
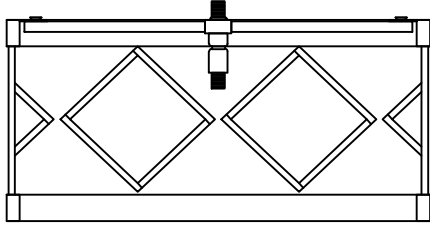
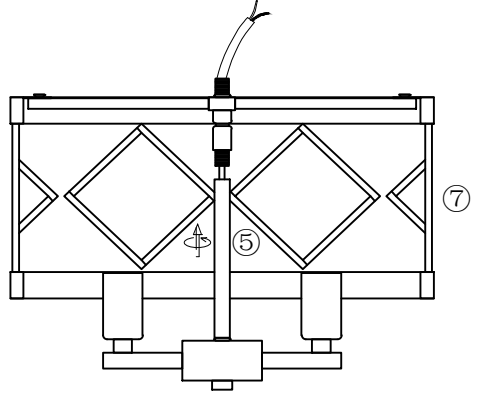
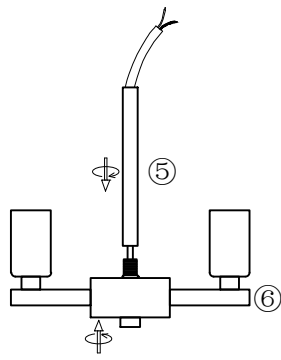
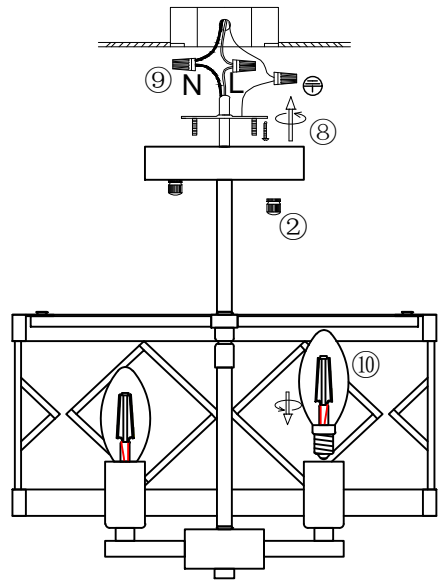
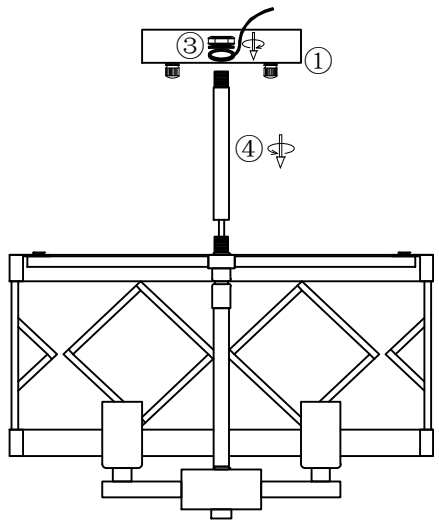

3. Loosen and remove out the lock nut and teeth lock washer ③ from the tube ④, let the wire go through the tube ④ and rotate to install the tube ④ to the fixture.

4. Install the canopy ① to the fixture with lock nut and teeth lock washer ③.

5. Install the bracket to the ceiling junction box with screw ⑧.

6. Connect the wire to the home line with cap connector ⑨.

7. Install the fixture to the bracket with cap nut ②.

8. Install the bulb ⑩.

ZJD00209-4

Please read carefully before installation!!!

Note : Please make sure that the electricity is powered off during installation !

Only a professional electrician should install this kind of product !