

HKKD-WG ASSEMBLY INSTRUCTION

(A) X1

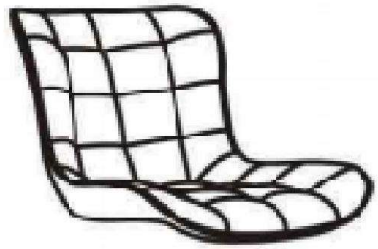

(D) X1

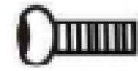

(E) X2



(B) X1

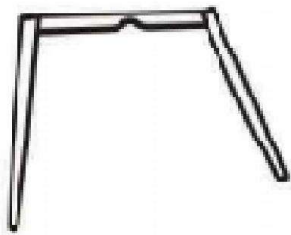

(F) X2



(C) X1

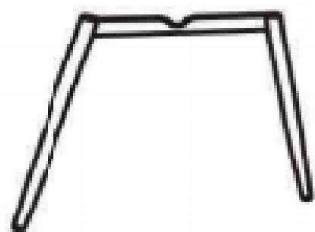

(G) X1



1

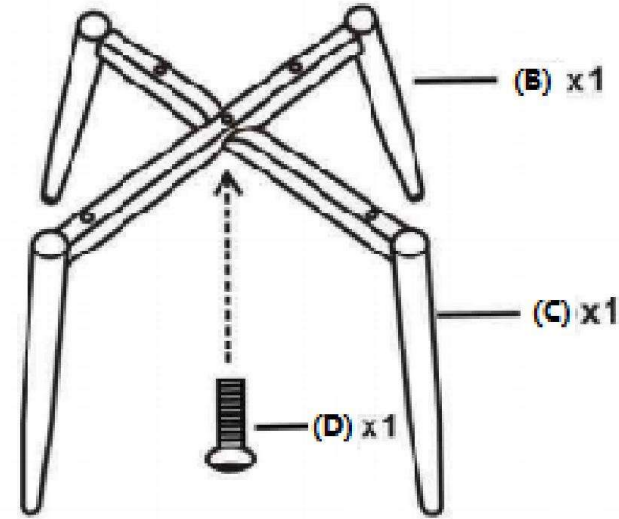

2

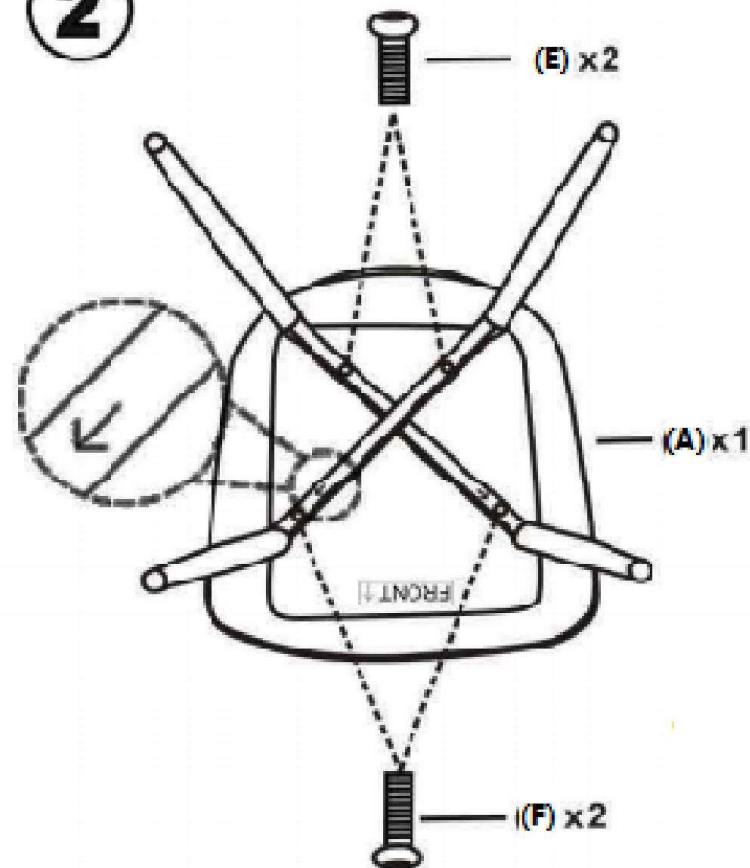



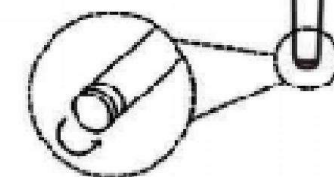

3

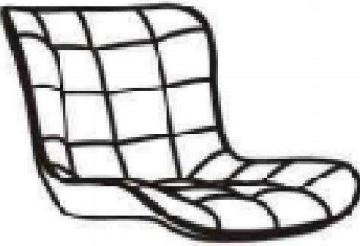

Feet adjustable

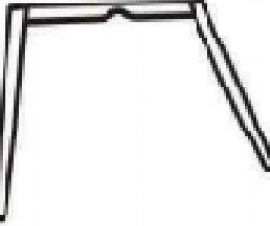
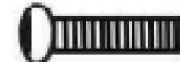
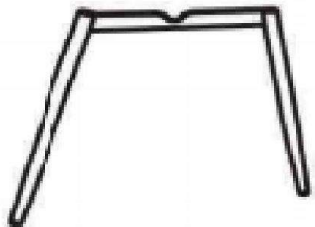
HKKD-WVG INSTRUCTIONS de MONTAGE

<p>(A) X1</p> 	<p>D X1</p> 
<p>E X1</p> 	<p>E X2</p> 
<p>(C) X1</p> 	<p>F X2</p> 
	<p>G X1</p> 