

# Manual Book

## Installation or Assemble Instructions

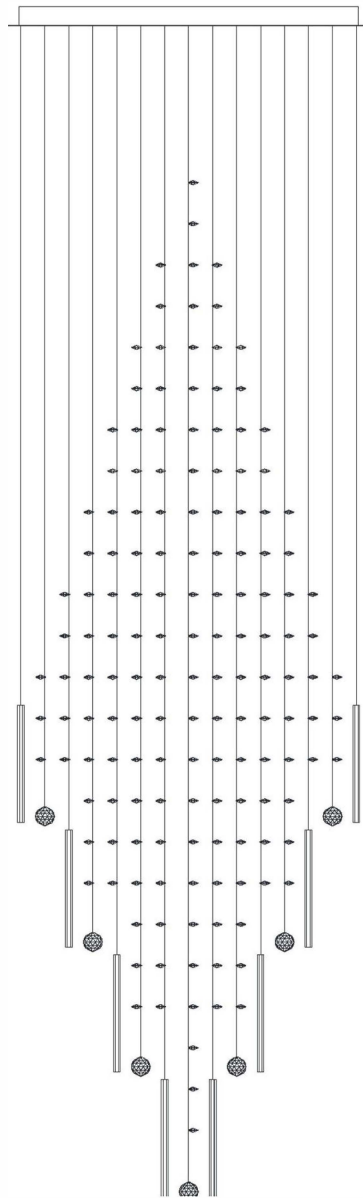

### Important note:

Please do not remove all the hanging strings of the bags at once for installation. You need to remove one string each time you install a crystal, otherwise there is a risk of knotting.

**WARNING:** Be sure the electricity to the wires you are working on is shut off ; Either the fuse is removed or the circuit breaker is turned off. Turning the power off using the light switch is not sufficient to prevent electrical shock.

**NOTE 1.** The important safeguards and the instructions appearing in this manual are not meant to cover all possible conditions or situations the may occur. It must be understood that the common sense,caution and care are factors which cannot be built into any product. These factors must be supplied by the person(s) installing this unit.

**NOTE 2.** Before installing, you need to check with your house builder or the installer to make sure that your ceiling can support the weight of the chandelier.

**NOTE 3.** The chandelier must be installed by a licensed, bonded and insured electrician to do the electrical part of the installation

**NOTE 4.** The outlet box and bracket support structure must be securely mounted and capable of reliably supporting more than 10lb( 5KG) - 330lb (150KG)

**NOTE 5.** The Chandelier must be mounted with a minimum of 7 ft. (2m) clearance from the ceiling edge of the to the floor.

**NOTE 6.** The chandelier has its own dimmer and cannot be used together with your own dimmer (to avoid short circuit).

**NOTE 7.** After the base is installed and electric wires are connected, hanging the crystal strings should be straight forward, arrange crystal strings from the inside to the outside . It does take some time and patience, but it is totally doable by yourself. Or you can hire a handy man to do it for you whose hourly rate will be much lower than a professionally electrician.

# STEP 1: Preparation

## 1. The tools you need

Ladder, pliers, wire strippers, screwdrivers, power drill(optional), a drill bit(optional)

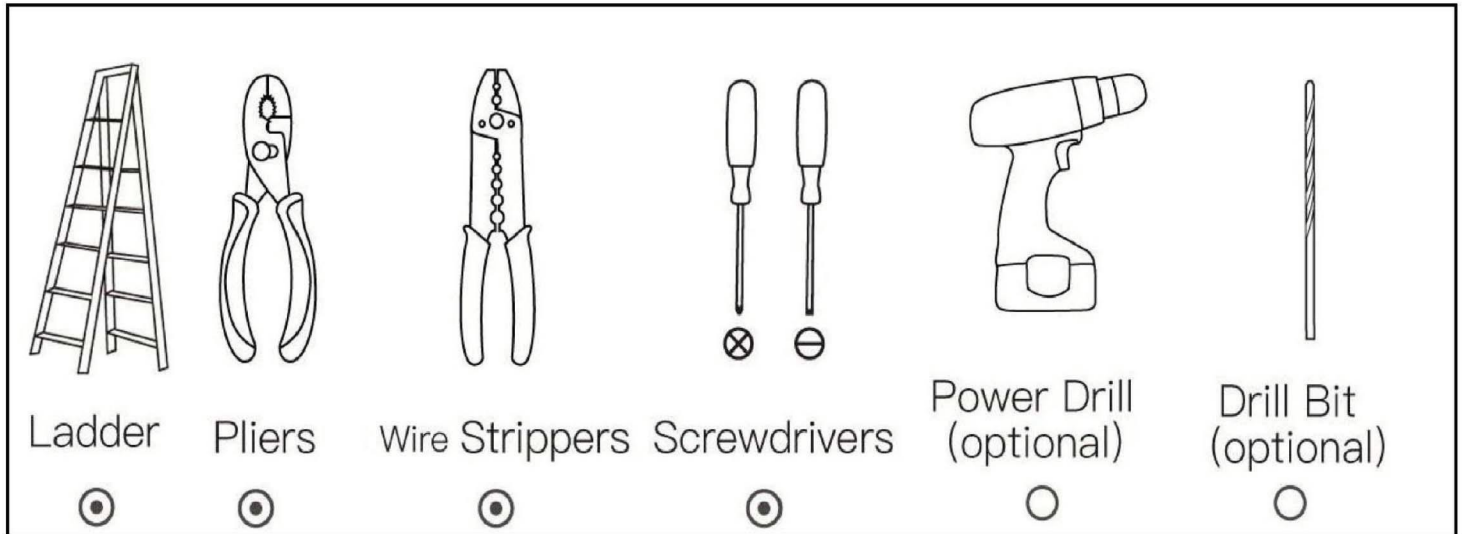

Tips: If mounting to a support structure, you will also need the other option tools.

## 2. Turn off the power

Turn off power at the circuit box to avoid possible electric shock.

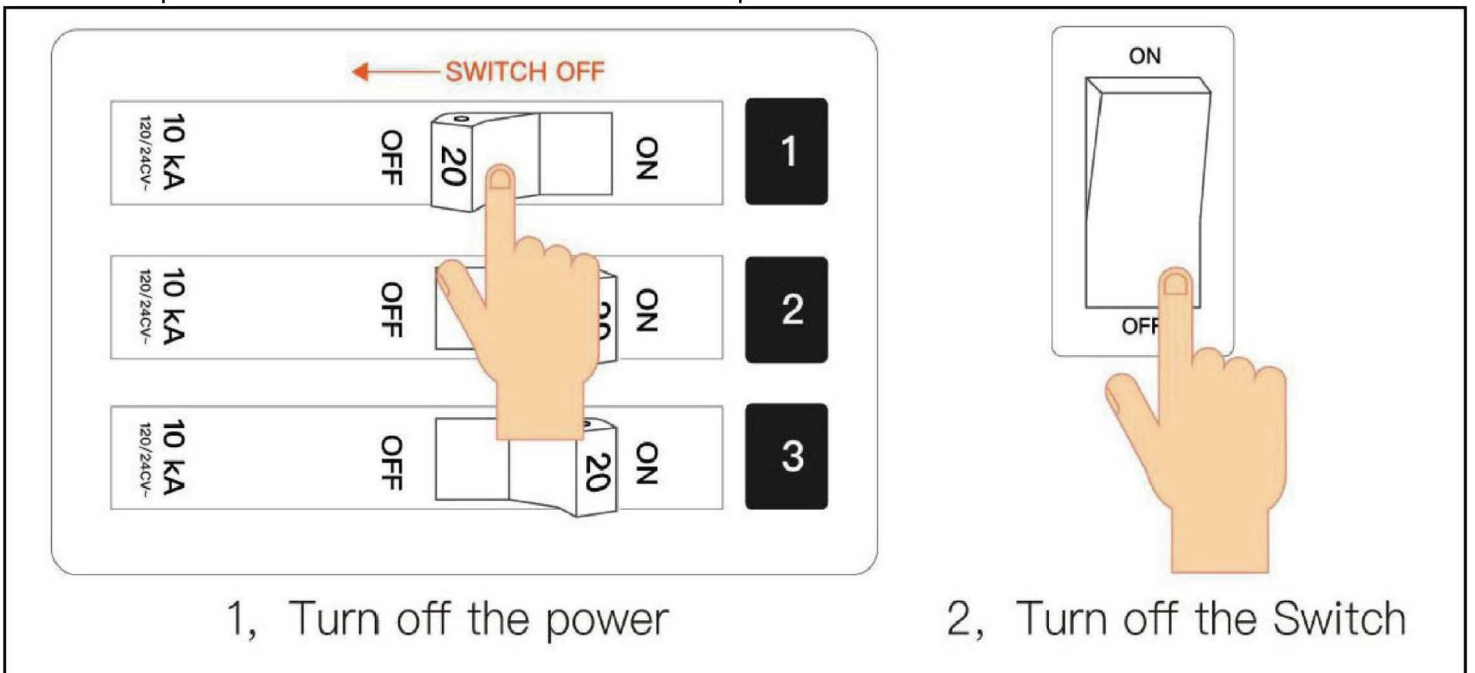

Tips: To ensure safety, you can test with a measuring pen, or you can turn on the light switch to make sure the power is off.

Flush Ceiling

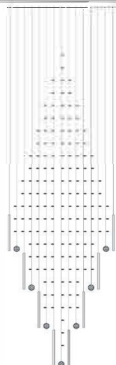

Sloped Ceiling

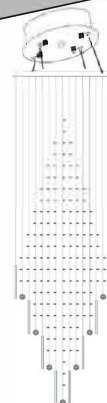

Roof'S Beam

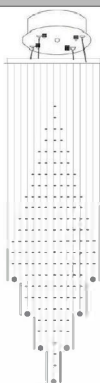

Groove Ceiling

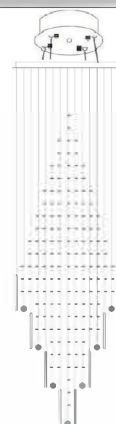

Schematic diagram of the small ceiling link:

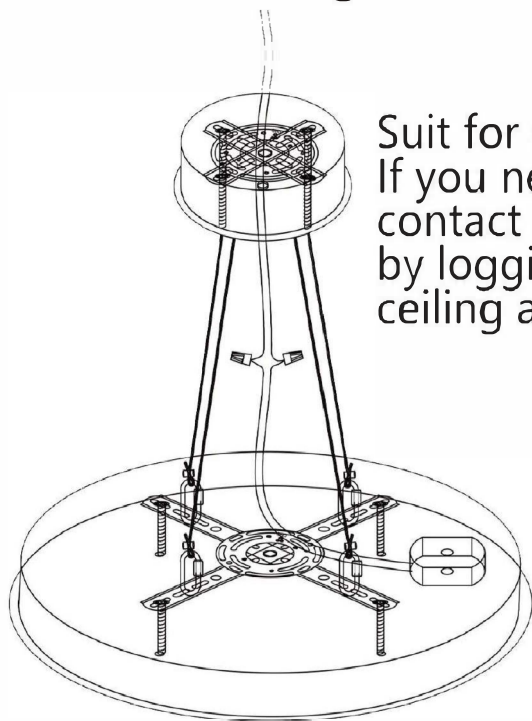

Suit for sloped ceiling, recessed ceiling, convex ceiling, If you need the reissue small ceiling accessories, please contact us. We will arrange for you. You can also find it by logging into the store and searching for the tilting ceiling adapter.

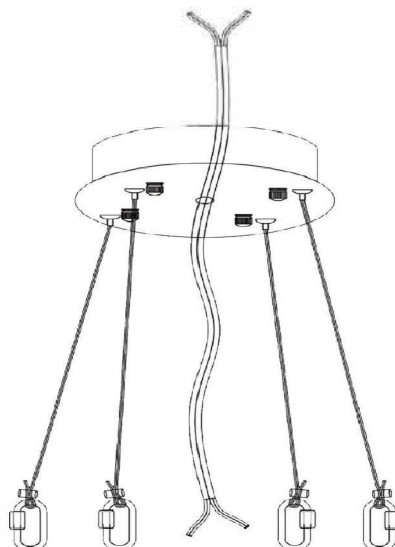

## STEP3 : Install the Mounting Bracket

②Place mounting bracket on ceiling and mark out the points where you need to drill holes.

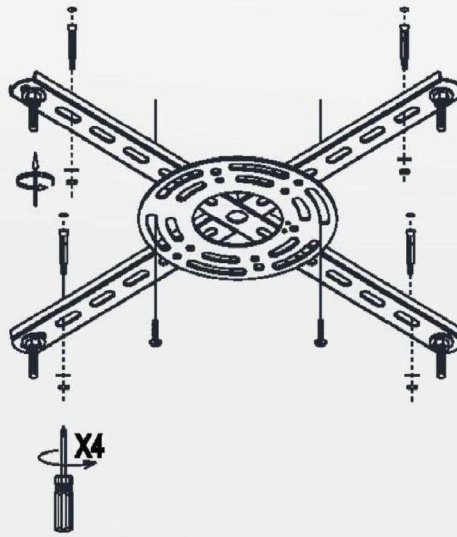
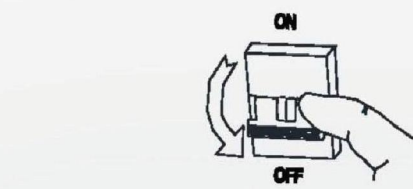

Tips: To ensure safety, you can test with a measuring pen, or you can turn on the light switch to make sure the power is off.

## STEP4: Install auxiliary ropes and connect wires

After the support is installed on the wall, please hook the end of the auxiliary rope to the lamp body for wiring procedure.

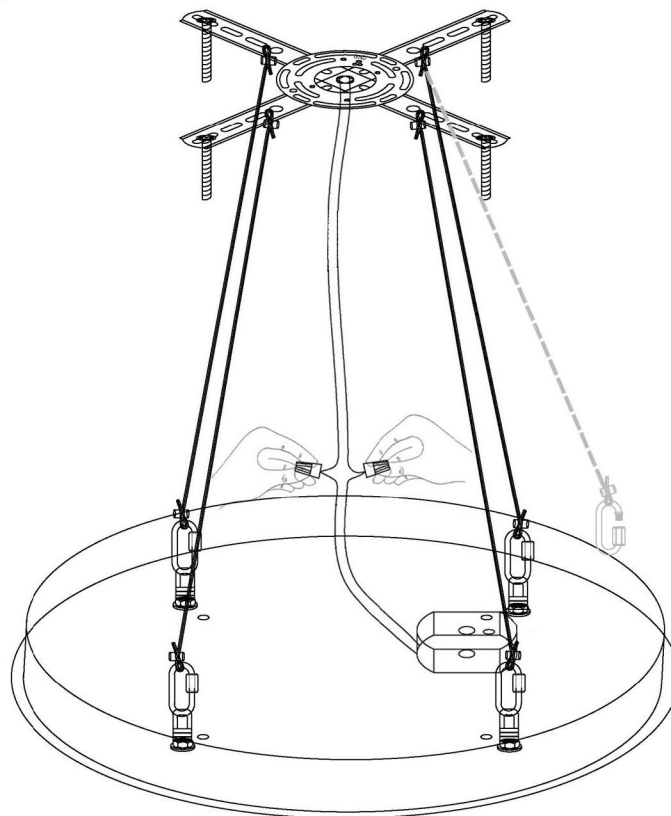

## STEP5 : Installation steps

- .The motor "green" wire to the "Ground wire" wire from outside Outlet Box.
- .The motor "white" wire to the "AC IN <N>" wire from outside Outlet Box.
- .The motor "black" wire to the AC IN <L>" wire from outside Outlet B
- .Finally,put the connected wires in the hanger.

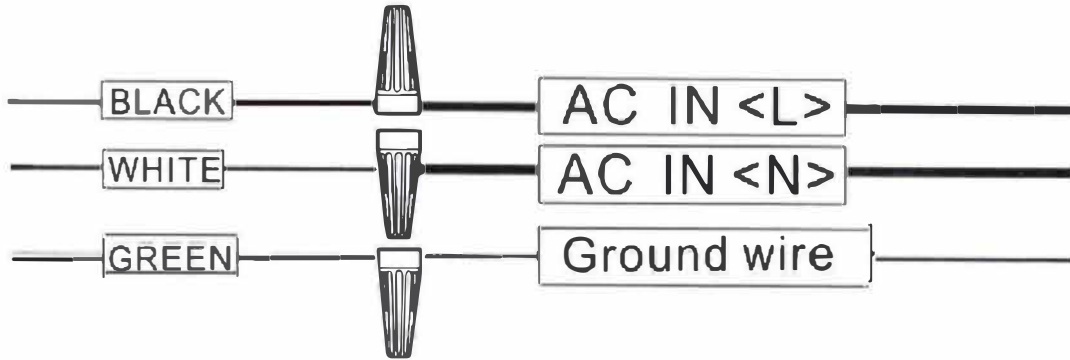

## STEP6: Install auxiliary ropes and connect wires

- ① Remove the mounting bracket from the ceiling plate of the chandeliers.

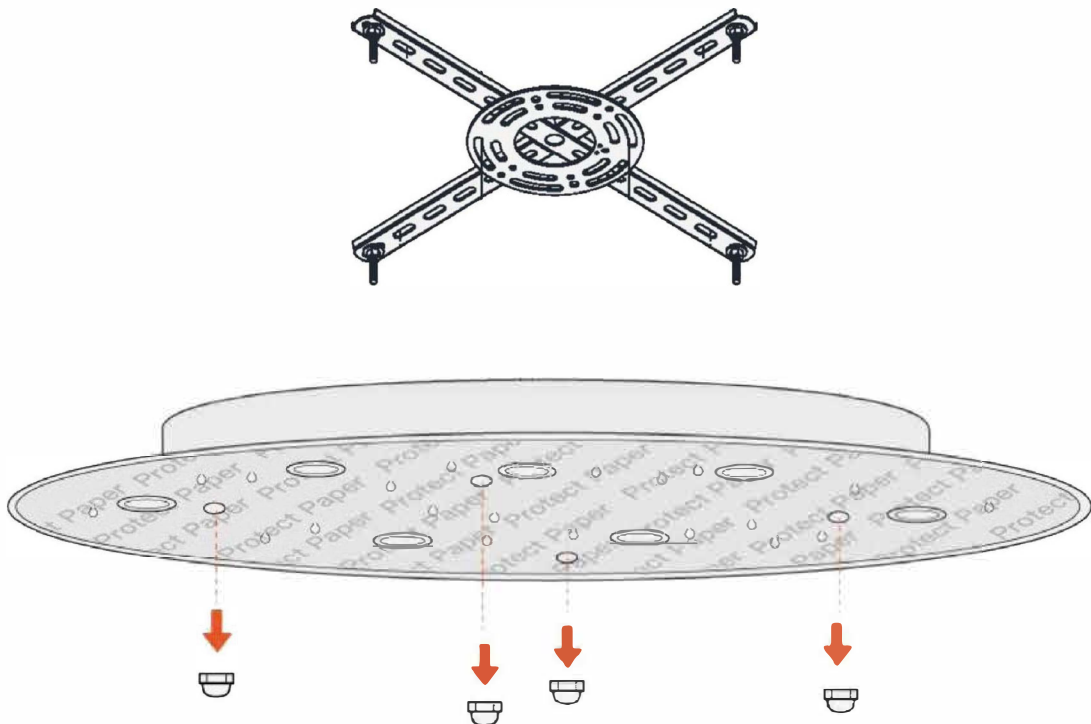

**STEP7: Attach canopy to the mounting bracket with bolt cap .**

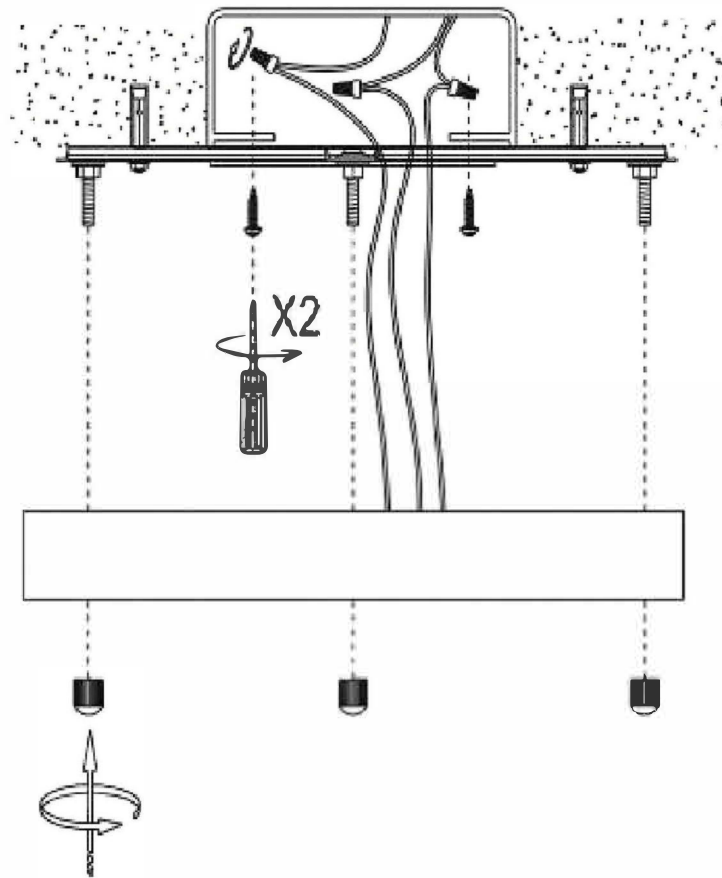

**STEP8: Connect wires and install the canopy.**

② Remove protective film on the canopy and chandelier base.

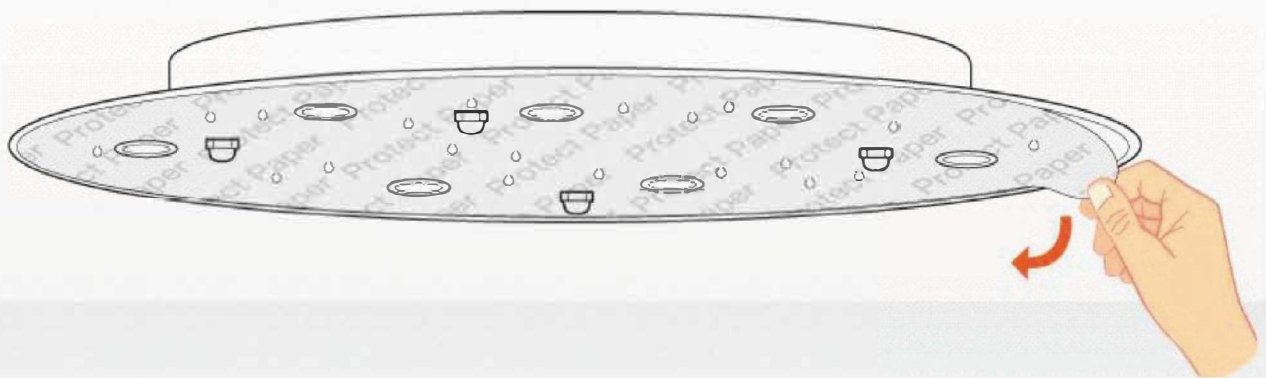

**STEP9: Install auxiliary ropes and connect wires**

Buckle the wire at one end of the crystal into the steel ring.

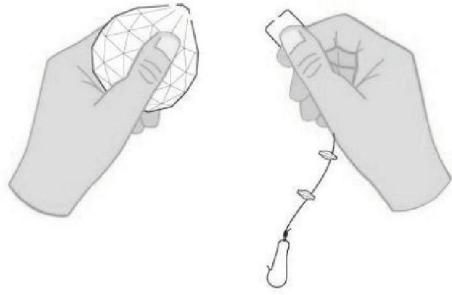

1

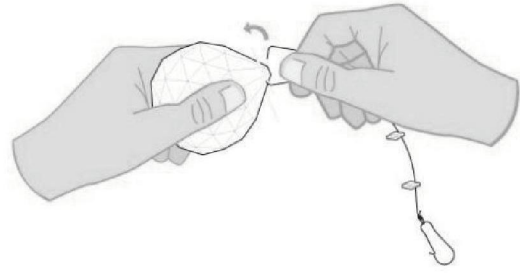

2

3

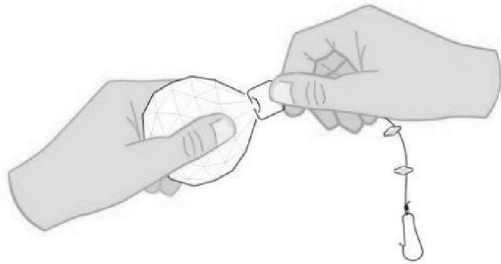

Done!

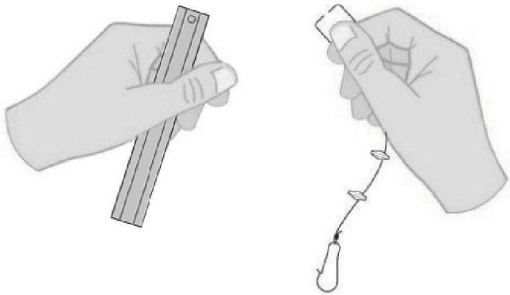
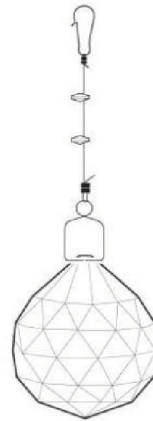

1

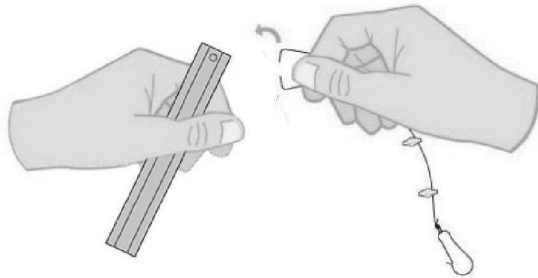

2

3

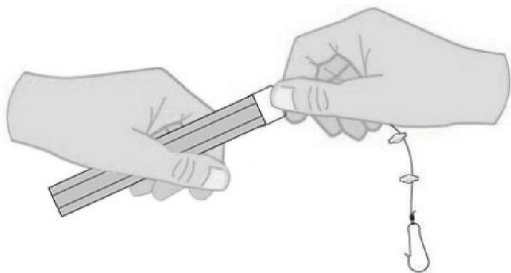

Done!



# Parts list

Open the package and check the contents. You should have the following conditions:

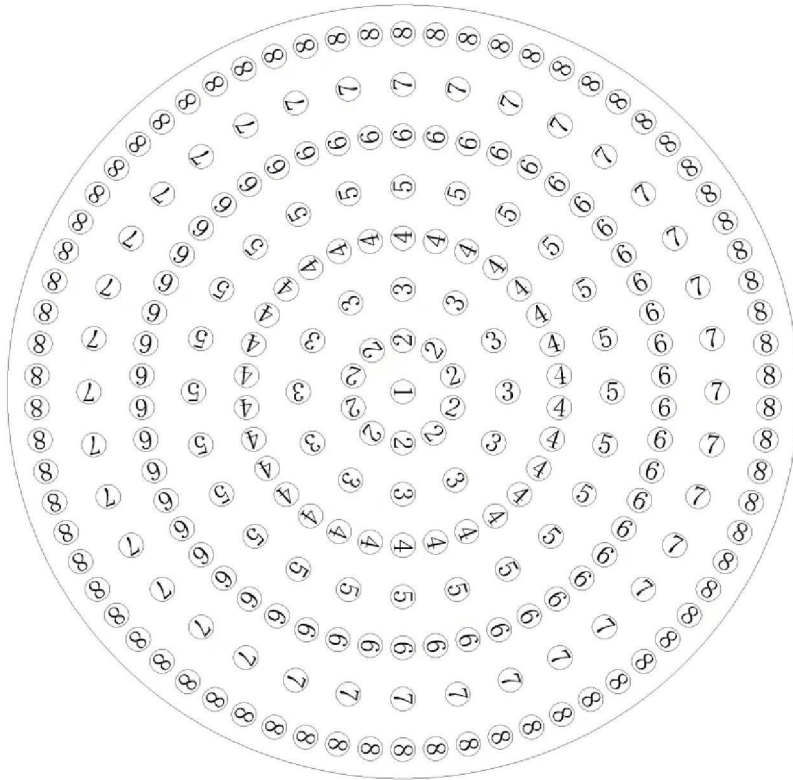

## Arrange crystal strings

To prevent the crystal string from tangling.

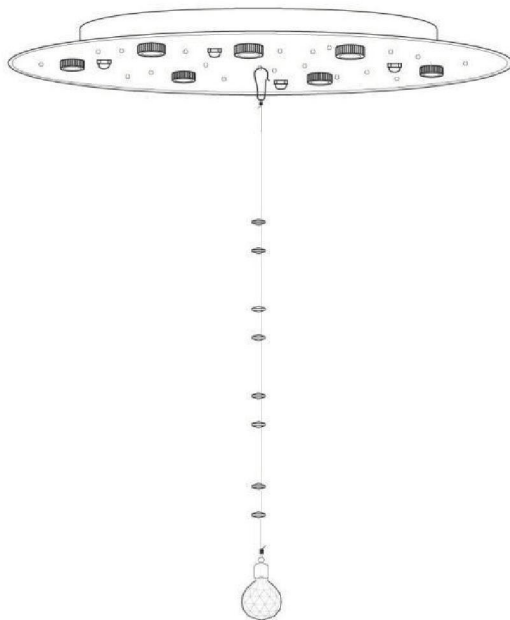

Done!

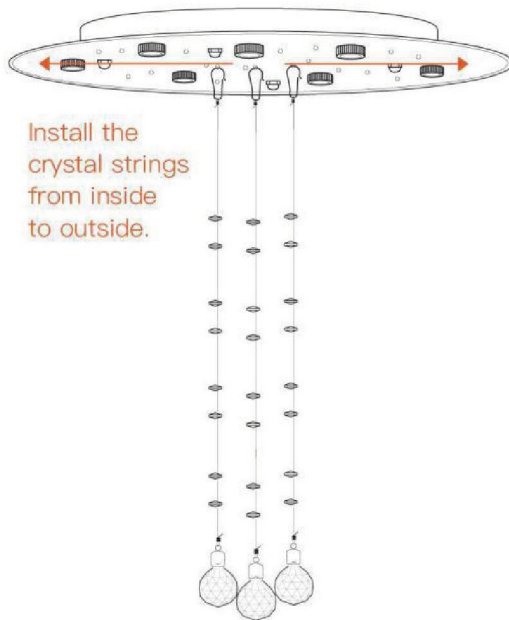

Install the crystal strings from inside to outside.

# Remote control manual

## Basic operation instructions:

1. Code alignment: The remote control can only be used after code alignment operation with the driver. The method is as follows: After connecting the driver to the load lamp (light source) and the power supply, switch on the power supply. At the moment of switching on the power supply (see Press (ON) within 3 seconds after the light/light source is on. When you see that the light (light source) will "flash three times slowly", that is, the code and grouping is successful.
2. Clear the code, the method is as follows: select the lamp that needs to clear the code, cut off the power, reconnect the power, after connecting the power light (Within 3 seconds), press the main open button five times, that is, the lamp/light source will "flash six times", to confirm the success of code clearing.

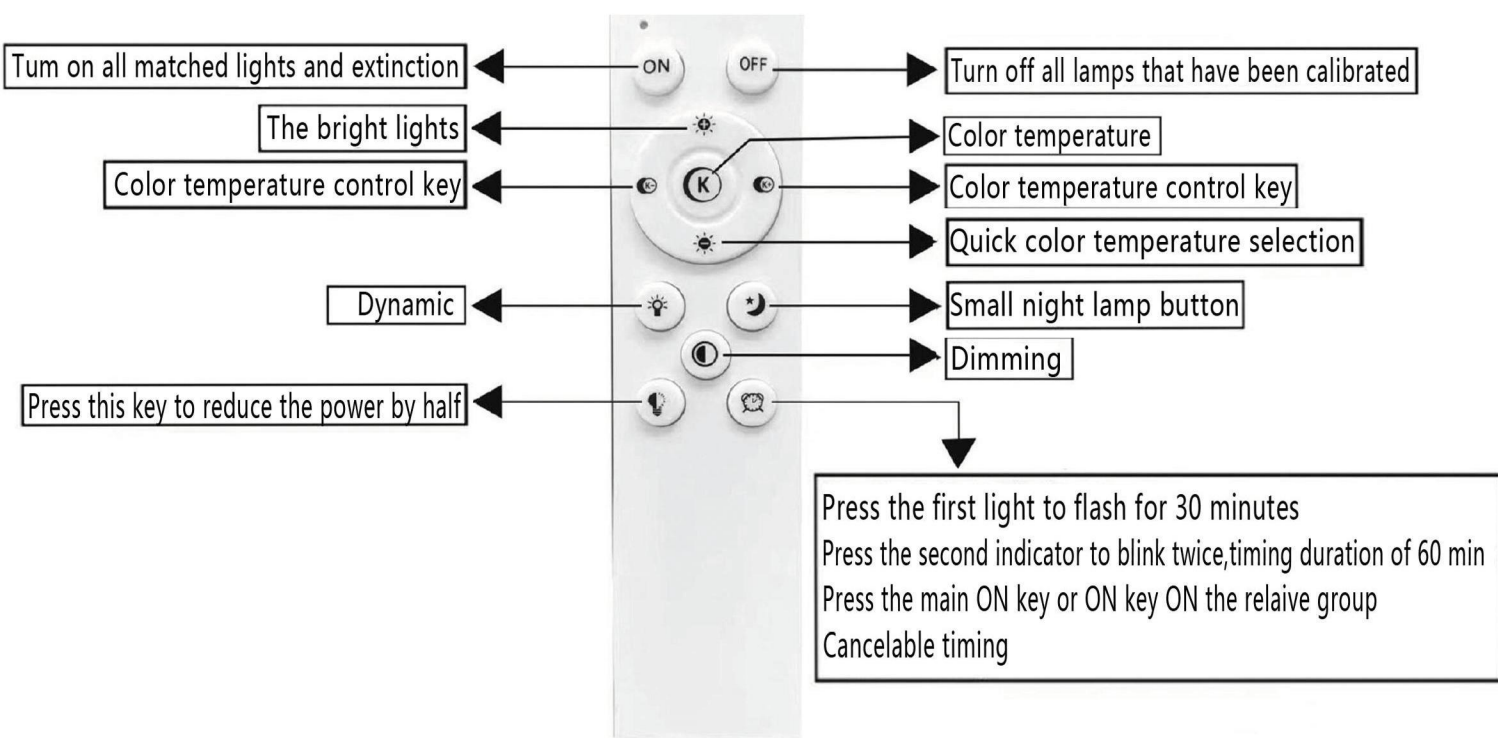

Our company warrants its chandelier light unit for Five year from the date of purchase. The warranty includes all parts provided, we provide the replacements for any missing or damaged parts. the unit is installed properly by a licensed electrician. Labor charges will be the responsibility of the purchaser. If the unit does not operate properly, the purchaser must contact us to determine if the unit was installed properly. Any alteration or by-passing of the electrical or mechanical system of exceeding the wattage maximum (as indicated on the chandelier) will void the warranty and can result in an electrical hazard.

If there are any problems about the item, please contact with us via order page.

## Regular Switch



## Dimmer Switch



**Avoid using all dimmer wall controls**