

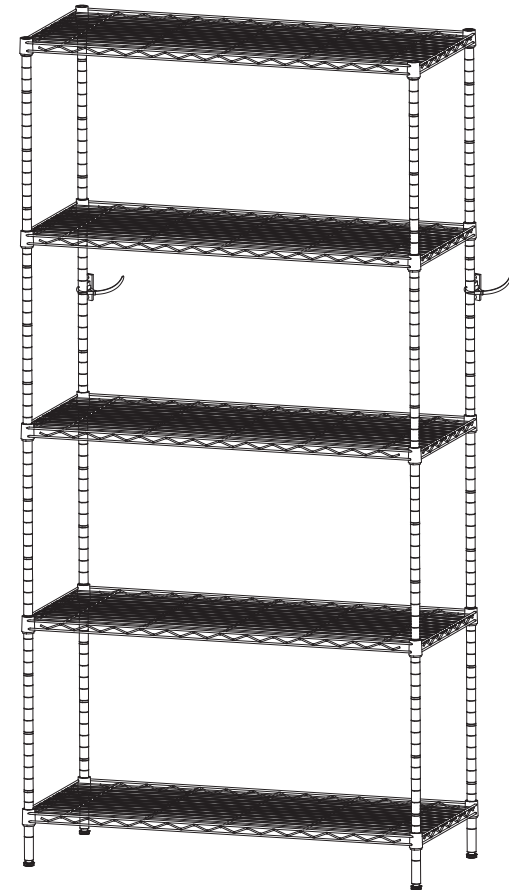

ASSEMBLY INSTRUCTION



Please check all parts and accessories according to the parts list before assembling, make sure all contents are sufficient and in good condition.

If there is any parts missing or defective, please contact us immediately with purchase platform message to get replacement parts.

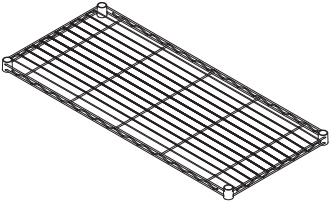
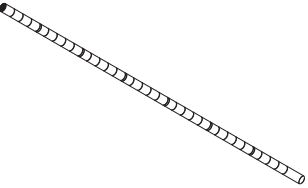
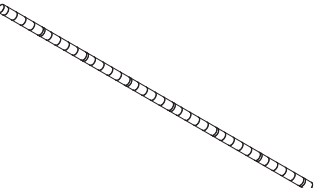
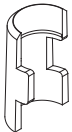
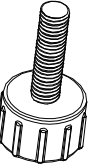
PART LIST:

<p>A</p>  <p>Steel Shelf x5</p>	<p>B</p>  <p>Lower pole x4</p>
<p>C</p>  <p>Upper pole x4</p>	<p>D</p>  <p>Clips x40</p>
<p>E</p>  <p>Adjustable Feet x4</p>	<p>N</p>  <p>Anti-Tip Device Kit x2</p>

HOW TO INSTALL

Step 1 Learn to install Clips on poles.

(1) Lock 2 Clips (part **D**) together to the poles.

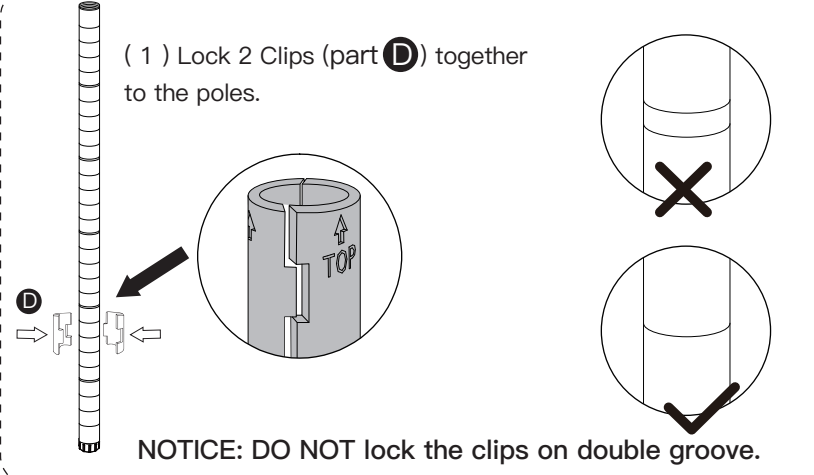

NOTICE: DO NOT lock the clips on double groove.

Slide down to

(2) Then slide them down to the height of Steel Shelves should be. (Once you hear the “ting” sound, it’s perfectly locked)

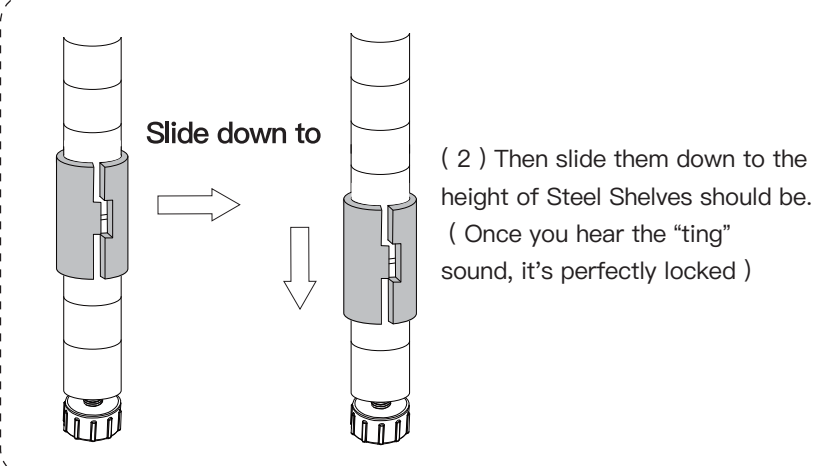

NOTICE: Every Clip (Part **D**) installing in same step must be at the same height.

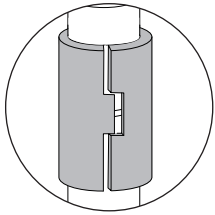

Note:

There is a gap between 2PCS plastic clips assembled onto the poles as shown in the picture, this is a structural design rather than a quality issue, which aims to bind the shelves firmly onto the pole.

Step 2 Install (part **A**) on part (**B**).

(1) Lock Clips (part **D**) on each Lower Pole (part **B**).

NOTICE:

Please install the clips as lower as possible to ensure the shelf is closer to the ground for better stability.

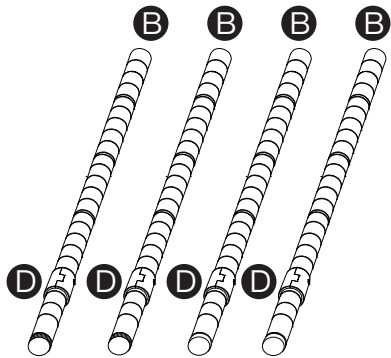

(2) Install the adjustable feet (part **E**) on each Lower Pole (part **B**).

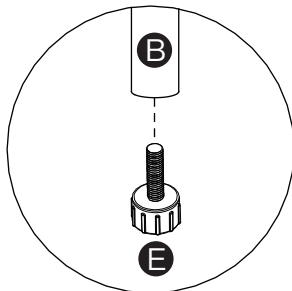

x4

(3) Install Steel Shelf (part **A**) onto the Clip Groups.

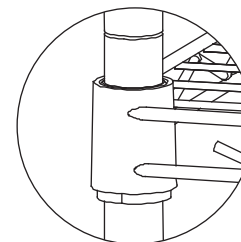
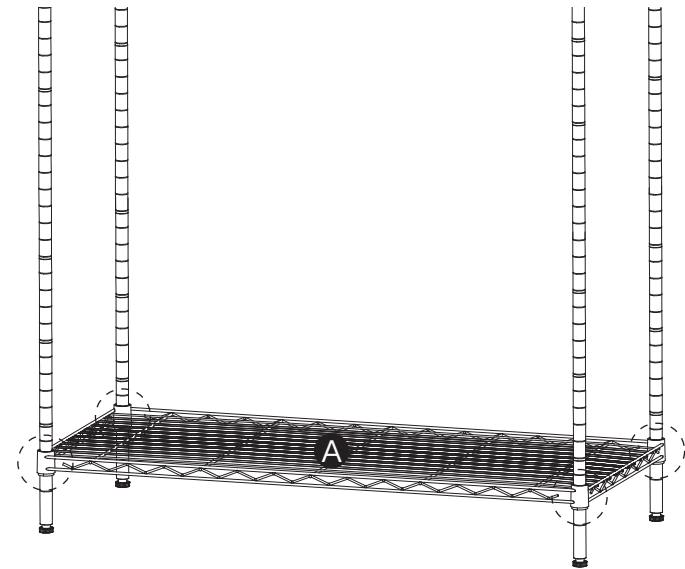
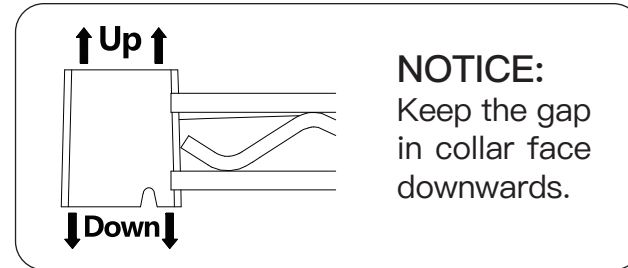

NOTICE:

Make sure the steel shelf is fully knocked as shown.

(4) Repeat previous steps, install the second Steel Shelf (part **A**) on the rack.

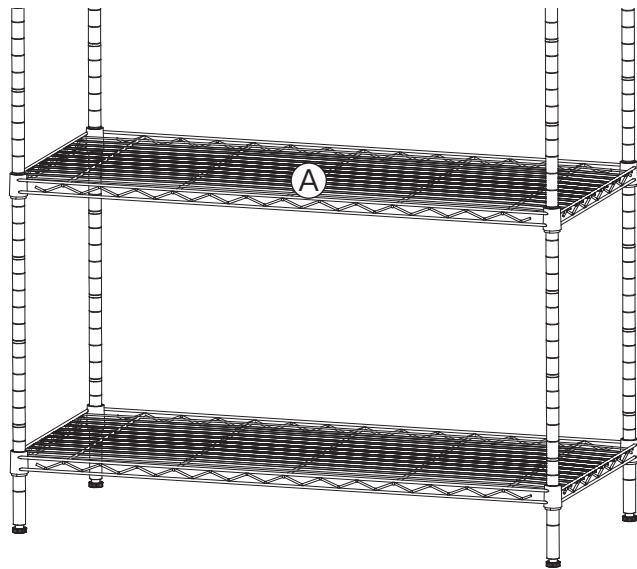

Step 3 Connect 4 Upper Poles (part **C**) on 4 Lower Poles (part **B**).

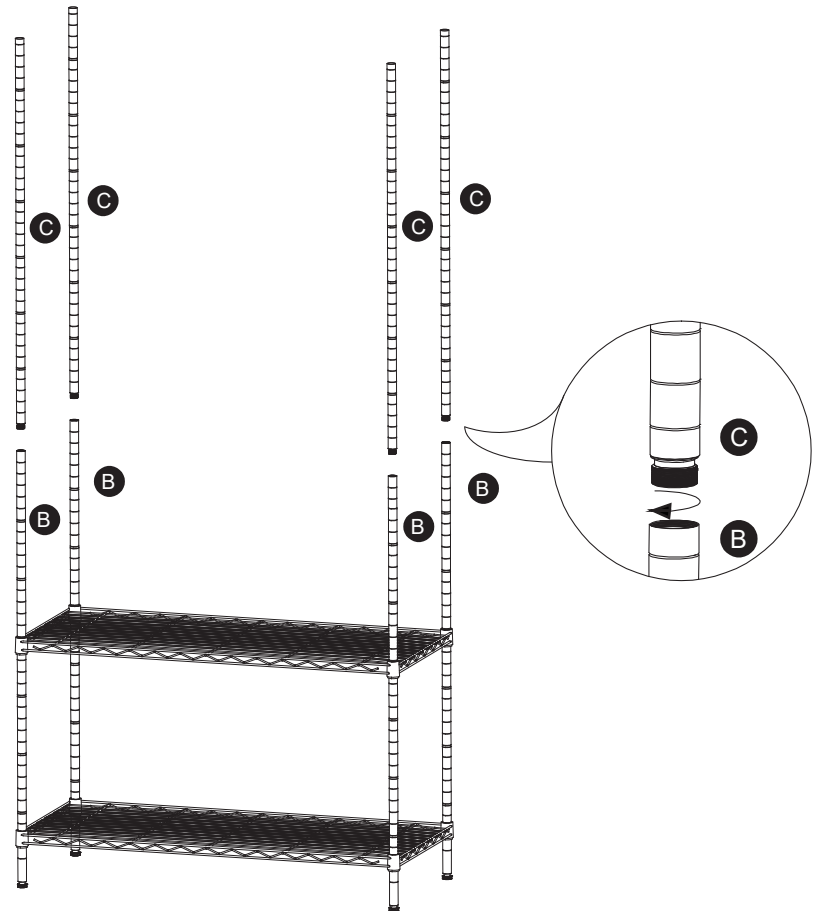
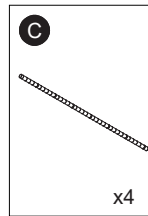

REMARK :
After each shelf is assembled, please put a piece of cloth on shelf and hit it several times with a tool (eg. A rubber mallet) to ensure more stability.

Note:
The rubble mallet is not included on the package.

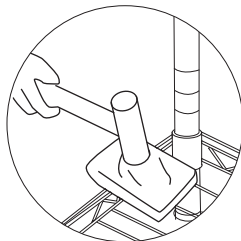

Step 4 Install part **A** on part **C** to finish.

(1) Lock Clips (part **D**) on each Upper Pole (part **C**) (Refer to Step 1) .

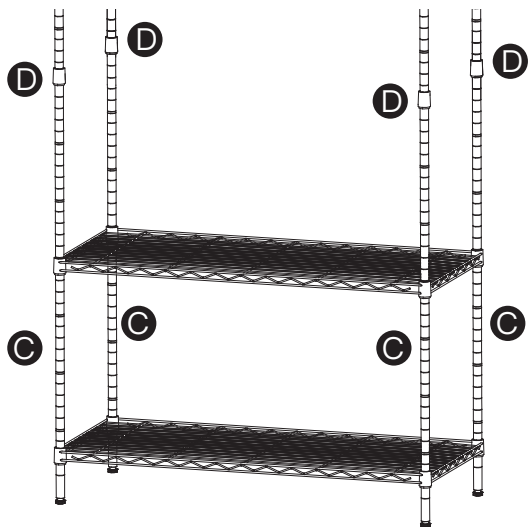

(2) Install Steel Shelf (part **A**) onto the Clip Groups.

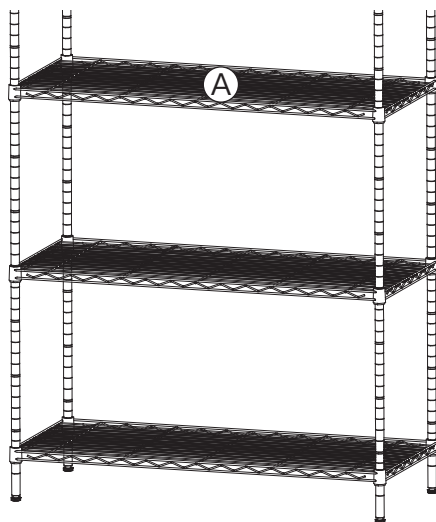

(3) Repeat step (1) and step (2) to install the 4th and top Steel Shelf (part **A**) on the rack.

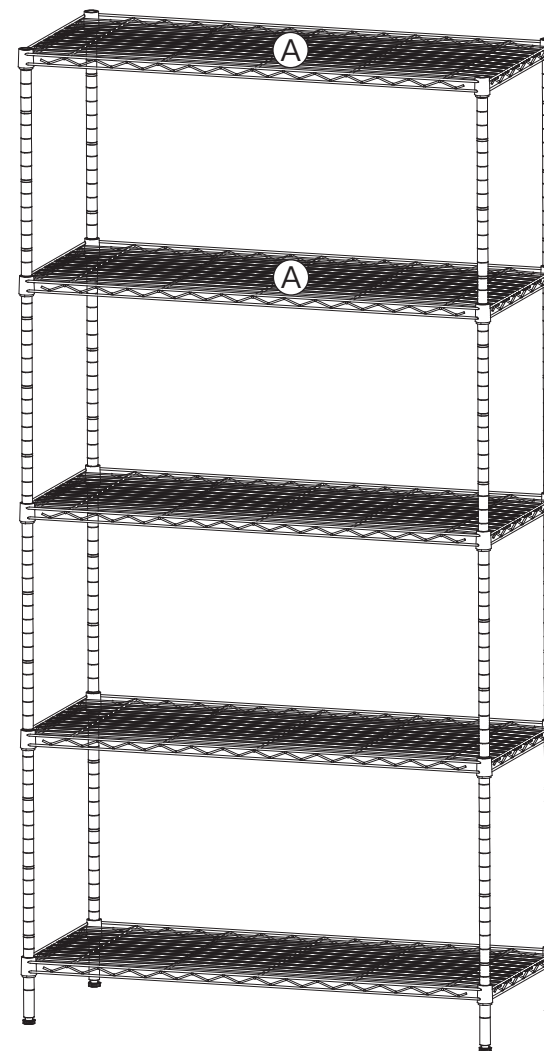

Step 5 (Optional) Install (part **N**) to keep the rack more stable.

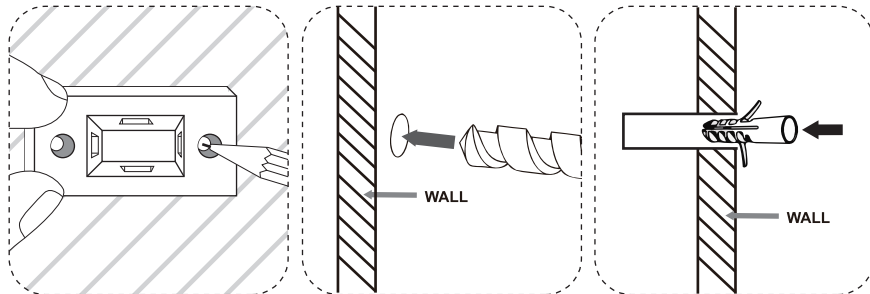

- (1) Mark the location of bolt hole. (2) Drill holes at marked location. (3) Press the protective bolts in the wall.

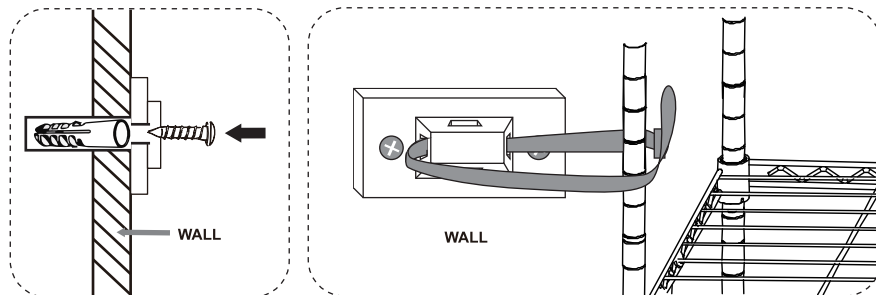

- (4) Fix the safety lock on the wall with bolts. (5) Get the safety belts cross the lock and clothes rack, then get fastened.

After-sales Service

Dear customer,

We're excited that you've chosen our product to be a part of your home. We care deeply about your experience and want to make sure you have all the help you need.

If you have any questions while assembling your new product, don't hesitate to contact our dedicated customer support team through the original purchase platform.

Creating your ideal space is important, and we're committed to helping you every step of the way.

Thank you for choosing us, where comfort and style meet practicality.

Sincerely,
Customer Service Manager