

3 Door Shoe Cupboard

Instruction manual

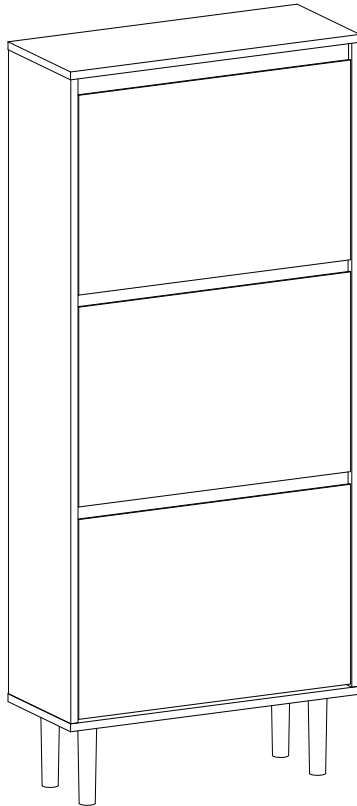

CONTENTS

Safety and care advice	1
Components – parts	2
Assembly instructions	4
Copyright	12



SAFETY AND CARE ADVICE



PLEASE READ THESE INSTRUCTIONS CAREFULLY AND KEEP FOR FUTURE REFERENCE

Warning:

·This unit weights approximately 26.5kgs. Please lift with care.

·Check you have all the components and tools listed on pages 2 and 3.

·Remove all fittings from the plastic bags and separate them into their groups.

·Keep children and animals away from the work area, small parts could choke if swallowed.

·Make sure you have enough space to layout the parts before starting.

·Do not stand or put weight on the product, this could cause damage.

·Assemble the item as close to its final position (in the same room) as possible.



·Assemble on a soft level surface to avoid damaging the unit or your floor (use opened out unit carton).

·We do not recommend the use of power drill/drivers **for inserting screws**, as this could damage the unit. Only use hand screwdrivers.

·**Safety note:** If there is any chance of this unit being pulled over by children etc. it is recommended that the unit is secured to a wall using suitable fixings .

·Dispose of all packaging carefully and responsibly.

CARE AND MAINTENANCE

·Only clean using a damp cloth and mild detergent, do no use bleach or abrasive cleaners.

·From time to time check that there are no loose screws on this unit.

·This product should not be discarded with household waste. Take to your local authority waste disposal center.

Note : If required the next page can be cut out and used as reference throughout the assembly. Keep this page with these instructions for future reference

COMPONENTS

Ensure the following components are in the box before proceeding with assembly:

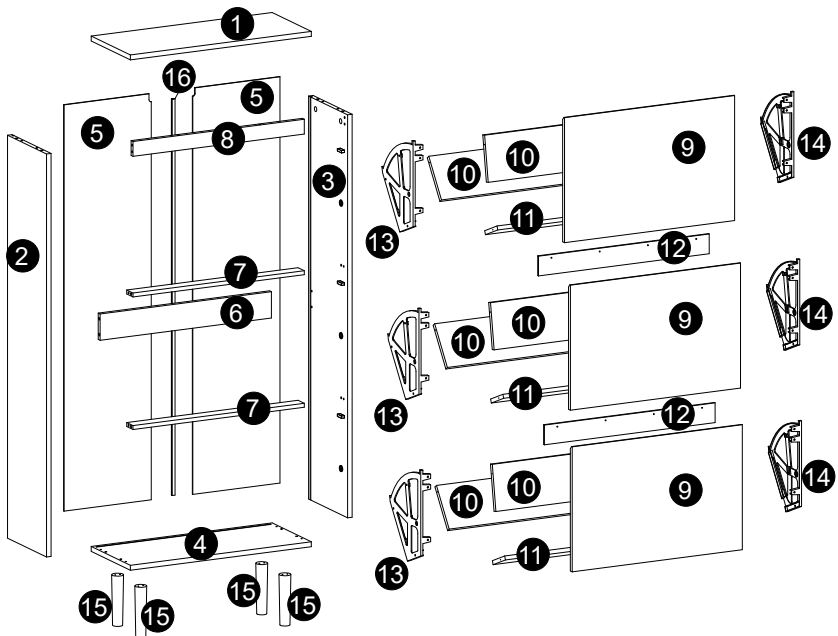

Parts List

1	Top Panel	x1	9	Door Front Panel	x3
2	Left Side Panel	x1	10	Shelf Panel	x6
3	Right Side Panel	x1	11	Base Panel	x3
4	Base Panel	x1	12	Decorative Front Slat	x2
5	Left/Right Back Panel	x2	13	Plastic rack left	x3
6	Back Slat	x1	14	Plastic rack right	x3
7	Middle Slat	x2	15	Leg	x4
8	Front Slat	x1	16	Back Panel Joint	x1

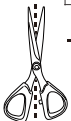

COMPONENTS — FITTINGS

Please check you have all the fittings listed below:

A



Peg M6*35 mm x 12

J



Screw M3*14mm x8

B



Lock M15*12mm x 12

K



Backboard Support x 14

C



Dowel M6*30mm x 18

L



Screw M3*14mm x 14

D



Screw M5*40mm x 4

M



Anti topple device x 1

E



Screw M4*12mm x 42

N



Wall plug x 1

F



Screw Insert x 6

O



Screw M4*35mm x 1

G



Metal plates x 4

P



Floor grip pad x 4

H



Screw M4*12mm x17

Q



Silicone crush pad x 6

I



Screw M4*30mm x 8

R





Door plastic stop x 6



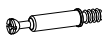

ASSEMBLY INSTRUCTIONS

Step 1

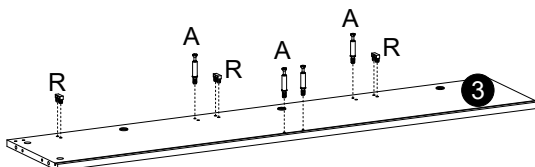
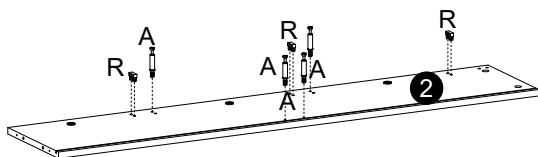
A		8
R		6



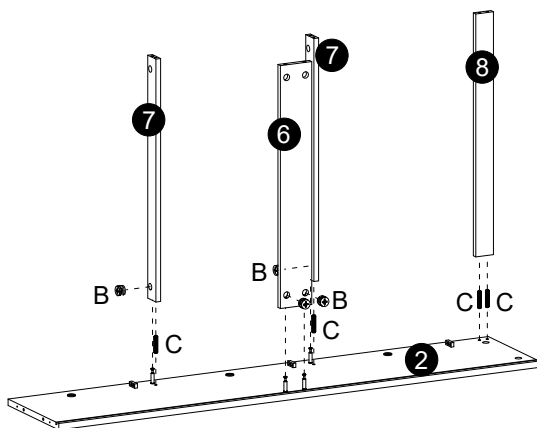

Step 2 The cam lock needs to be inserted in the open position and tightened once the dowel has been inserted.

B		4
C		4





ASSEMBLY INSTRUCTIONS

Step 3

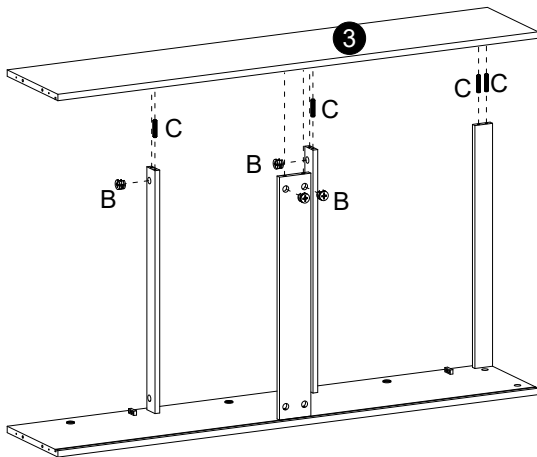
B		4
C		4



Step 4

D		4
C		4

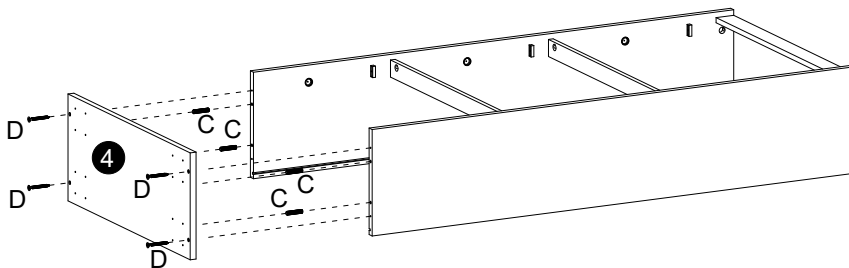



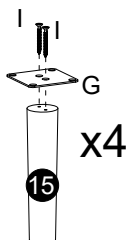

ASSEMBLY INSTRUCTIONS

Step 5



x4

Please assemble on an even surface.
Please lift the product into position. Do not drag.

G		4
H		16
I		8
P		4

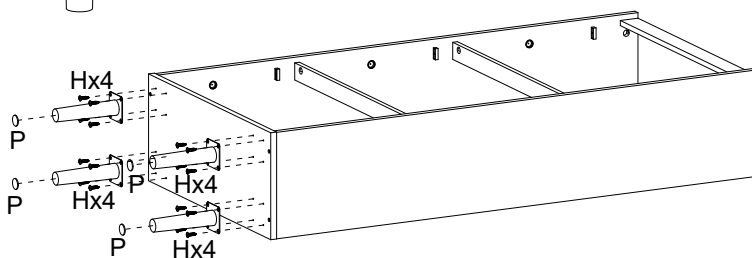

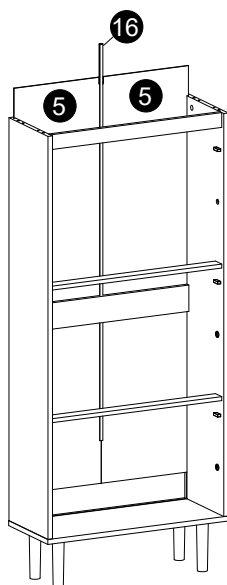

Step 6





ASSEMBLY INSTRUCTIONS

Step 7

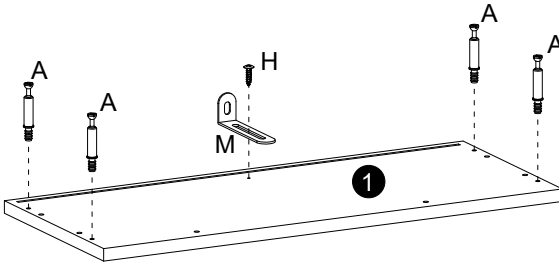
A		4
H		1
M		1



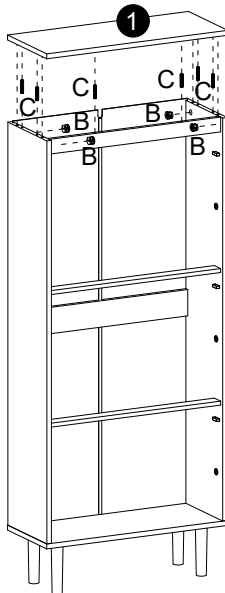

Step 8

B		4
C		6



ASSEMBLY INSTRUCTIONS

Step 9

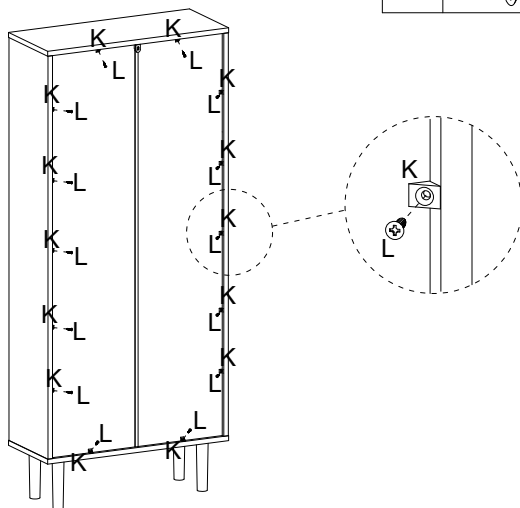

K		14
L		14

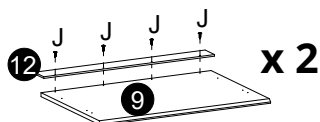

Step 10

1



E		20
J		8
Q		4

2

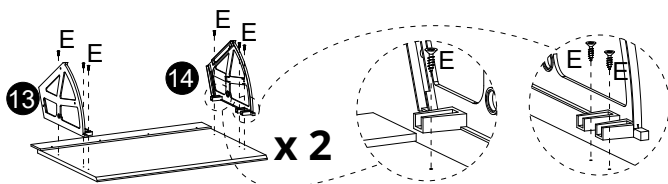

3

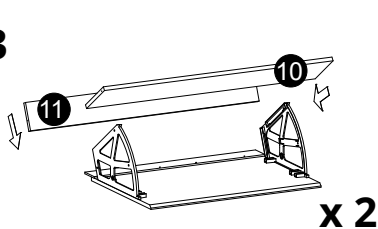

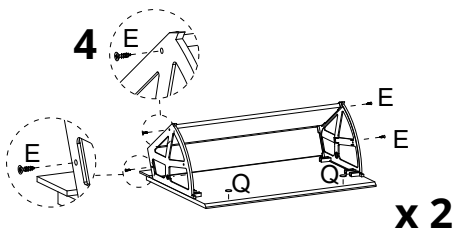

4





ASSEMBLY INSTRUCTIONS

Step 11

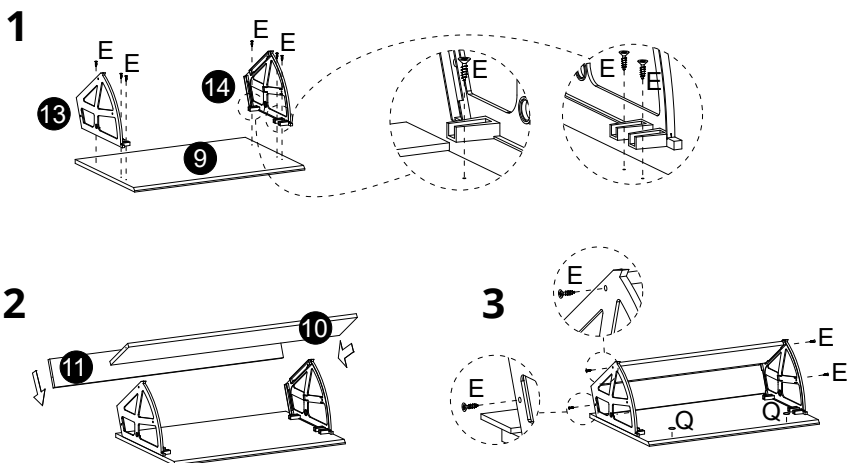
E		10
Q		2



Step 12

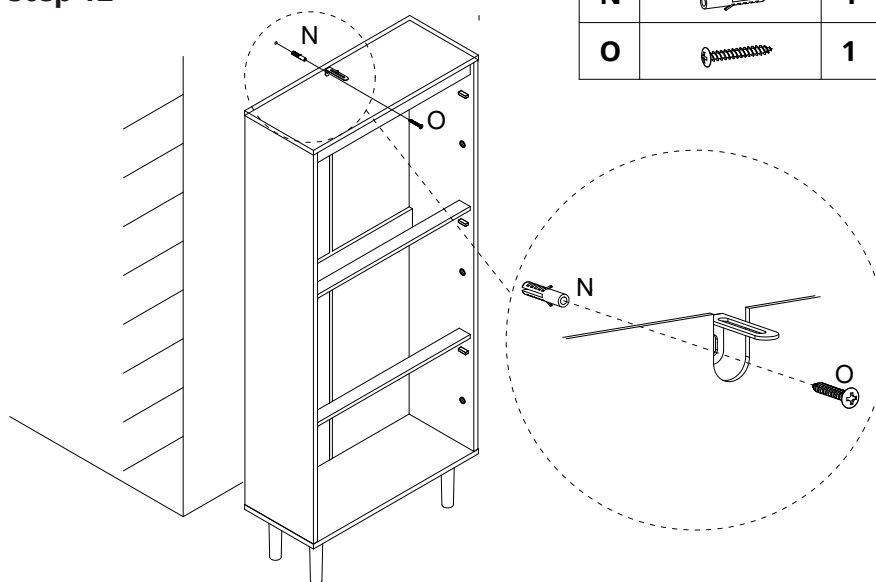

N		1
O		1

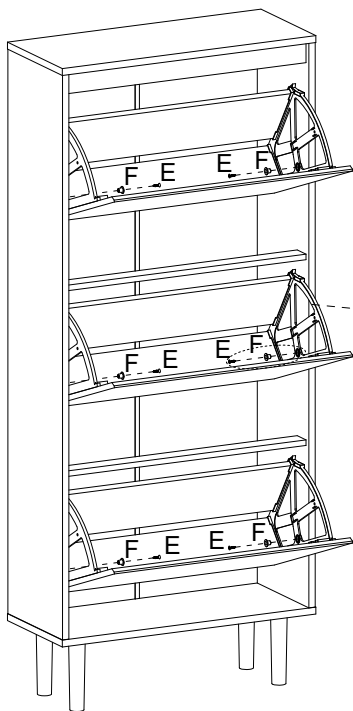

ASSEMBLY INSTRUCTIONS

Step 13



E		6
F		6

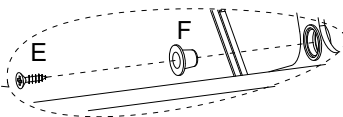

Step 14

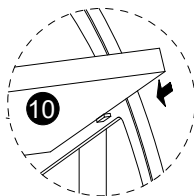
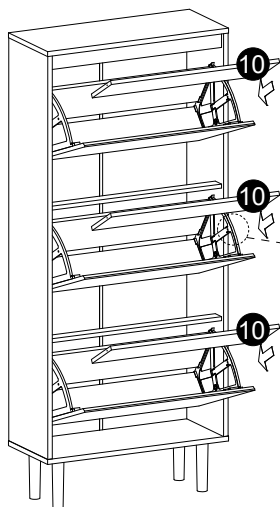

ASSEMBLY INSTRUCTIONS

Step 15

E		6
---	---	---

