

Assembly Instructions

Caution : You must read this before you proceed

Rocking Chair

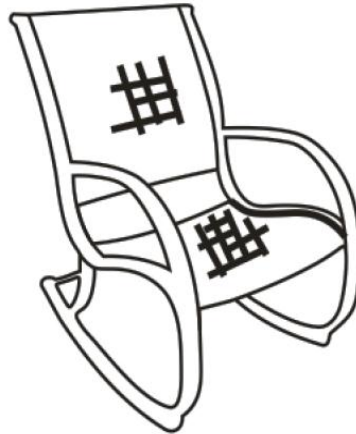

**CAUTION: This Rocking Chair is NOT a TOY.
Keep your child / children at bay during the assembly process.**

Part List

Label	Picture	Description	QTY
A		Right Leg with Arm	1
B		Left Leg with Arm	1
C		Cross Bar	1
D		Backrest Panel (Top end with Tag)	1
E		Seat Panel	1

Hardware

Label	Picture	Description	QTY
①		Blot with Flat Washer(M6*15MM)	3

②		Blot with Flat Washer(M6*20MM)	11
③		Bolt Cap	13
④		Allen Key	1

Assembly Preparation

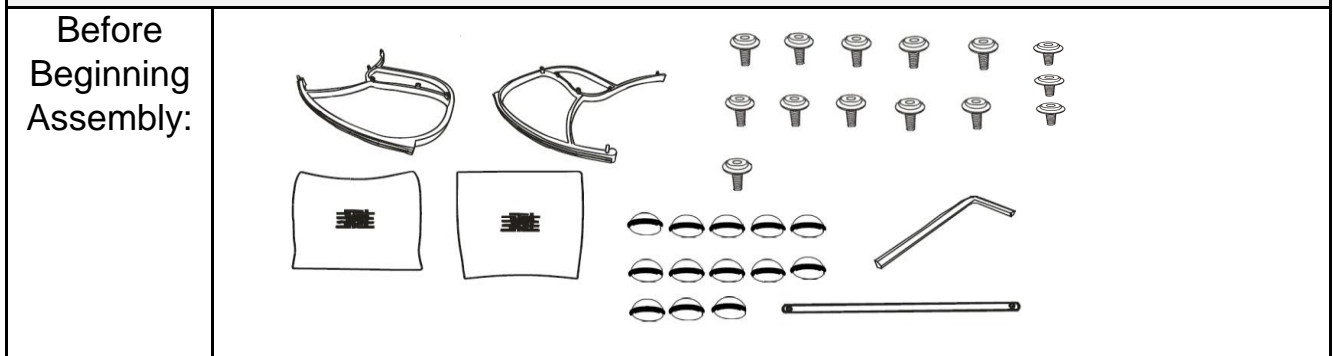

- Read instructions, cover to cover-



- Have 2 adults on hand for assembly-



- Do not assemble on flooring or carpet-



- Assemble on a clean non-marring surface (packing foam)-



- Save all packaging until finished-

Assembly Steps

Overview

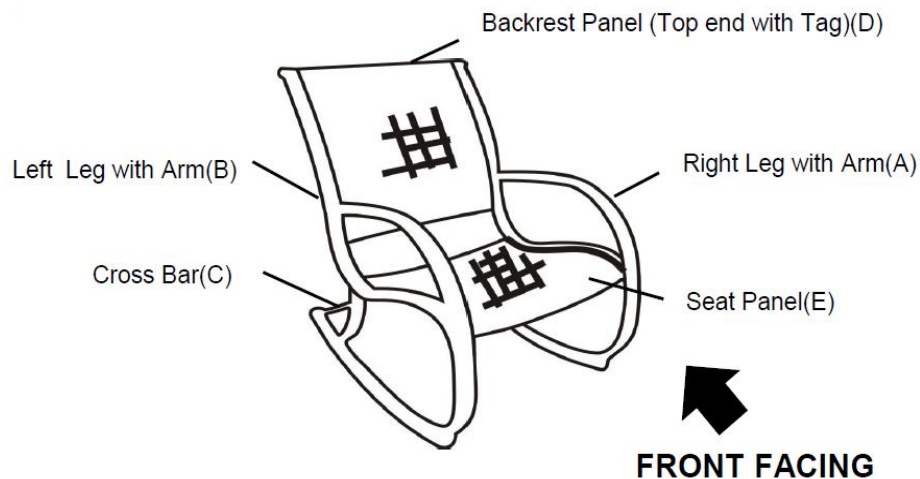

This Rocking Chair has multiple parts and may require up to 30 minutes to assemble. To give you an overview of the Rocking Chair parts, the above picture is to help you put the various parts into perspective. Please read through the instructions below to familiarise yourself with the parts and steps before assembly.

Step 1

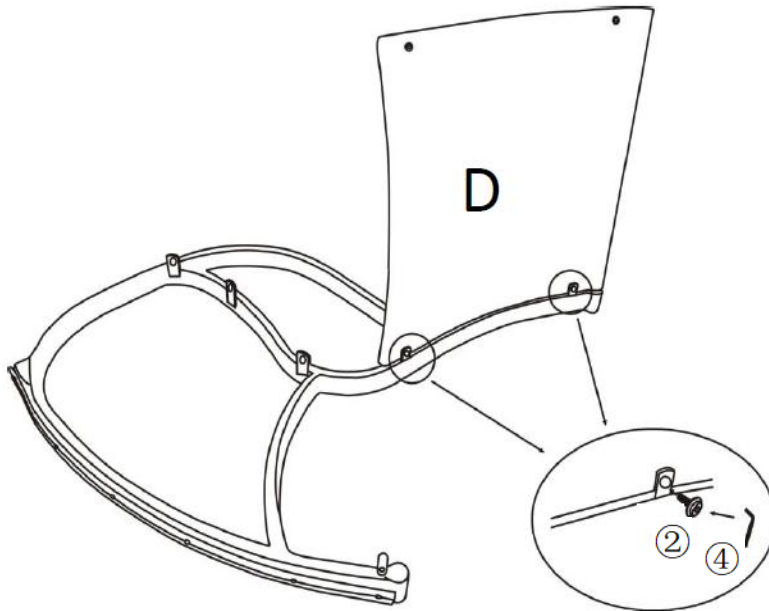

Open the carton and place all the parts onto a clean, non-marring surface. Attach Backrest Panel(D) to Left Leg with Arm(B) using Bolt with Flat Washer(②) and Allen Key(④).

Do not fully tighten the Bolt.

NOTE: It is recommended that you have a partner to assist during the entire assembly process.

Step 2

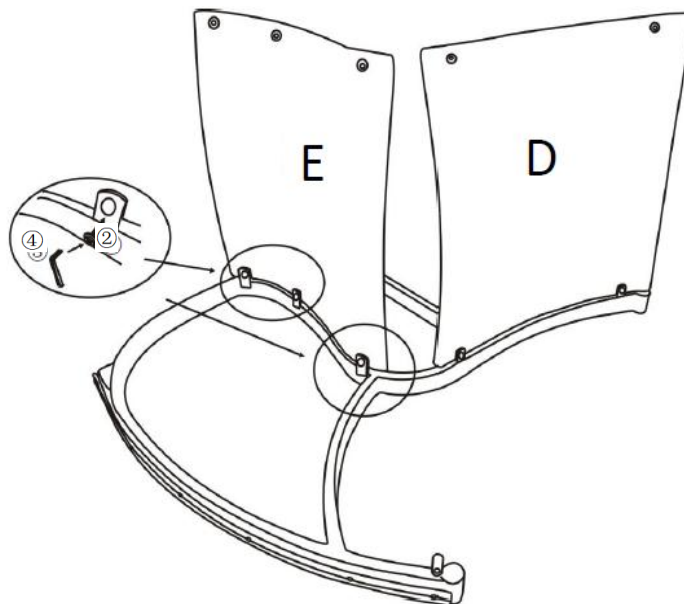

Attach Seat Panel(E) to Left Leg with Arm(B) using Bolt with Flat Washer(②) and Allen Key(④).

Do not fully tighten the Bolt.

Step 3

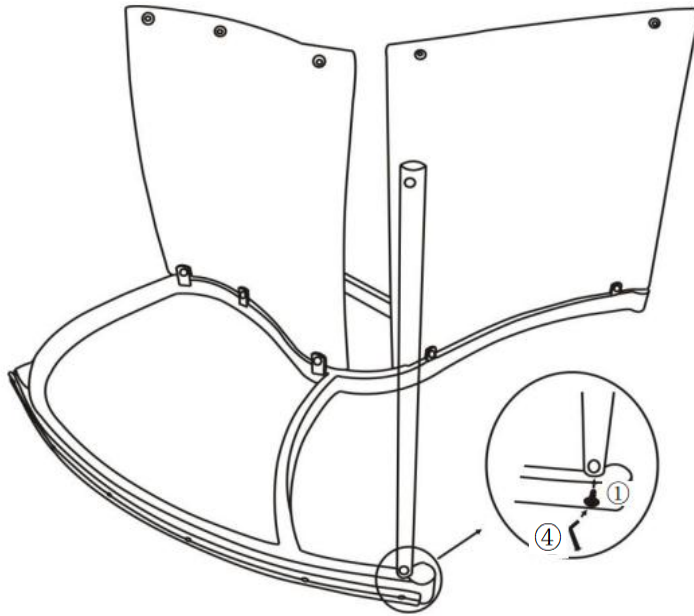

Attach Cross Bar(C) to the Left Leg with Arm (B) using Bolt with Flat Washer(①) and Allen Key(④).

Do not fully tighten the Bolt.

Step 4

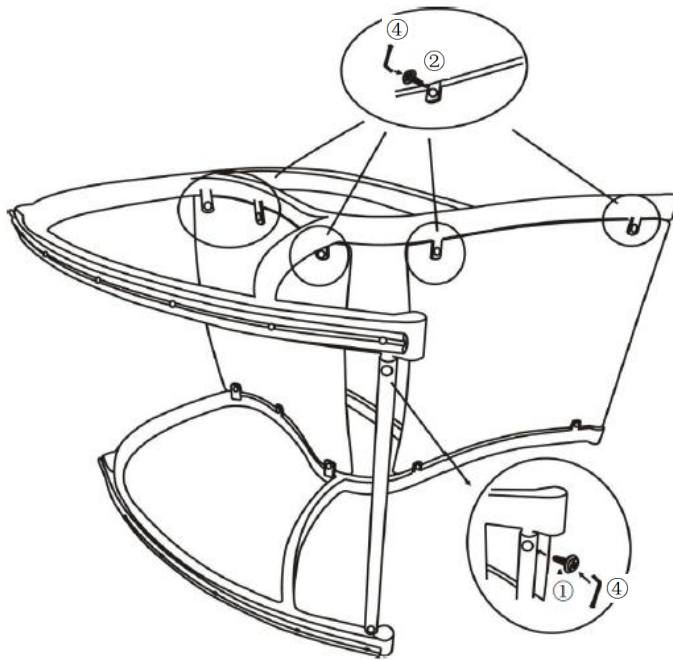

Attach Cross Bar(C), Backrest Panel(D) and Seat Panel(E) to the Right Leg with Arm (A) using Bolt with Flat Washer(①/②) and Allen Key(④).

Then fully tighten all Bolts at all joints.

Push Bolt Caps(③) onto the top of the Bolts by hand.



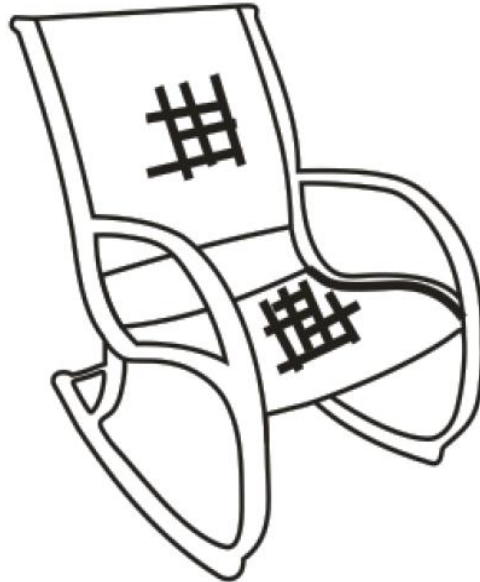

















Step 5



Turn Chair right side up.
Your Rocking Chair is ready for use.

Caution: The Chair should be used on a smooth, level surface. Children should be supervised at all times when using the Rocking Chair

Care & Maintenance

-   ● Do not put hot items directly on furniture surface
 -   ● Do not clean furniture with harsh cleansers or polish.
 -   ● To obtain the longest lifespan of your outdoor products, minimizing exposure to direct sunlight is recommended.
 -   ● Children should not climb or jump on the furniture.
 -   ● Do not write on furniture without a padded barrier to protect the surface.
 -   ● To obtain the longest lifespan of your outdoor products, avoid extended and lengthy exposure to rain, snow, and direct sunshine. Whenever possible cover the product and /or place under patio or awnings.
 -   ● Not for commercial use. For residential use only .
 -   ● Stains may be removed with mild soap solution and damp cloth.
 -   ● Keep away from sources of ignition.
-
-   ● Dust and pick-up spills using a clean, non-colored, lint-free cloth.