

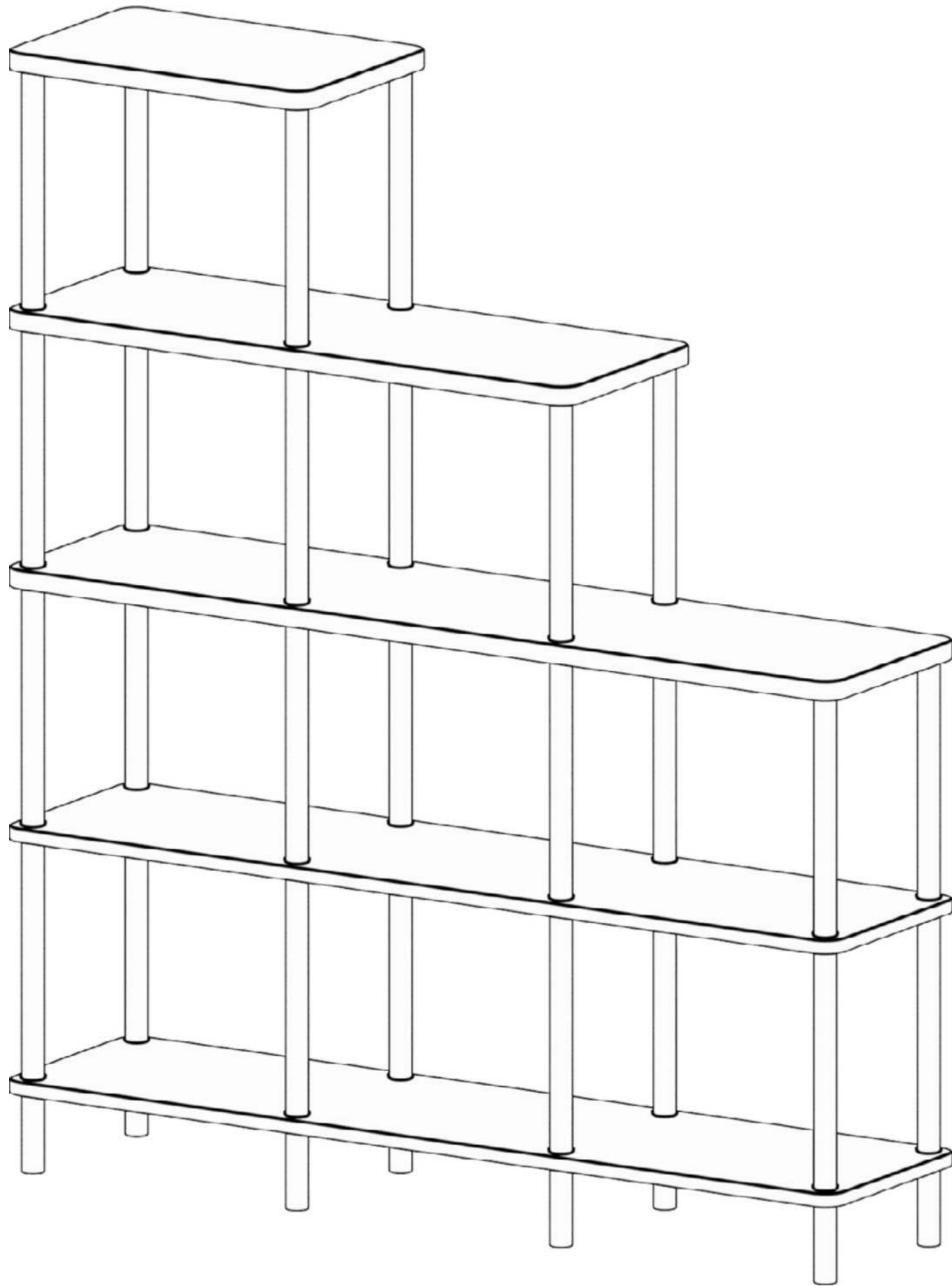

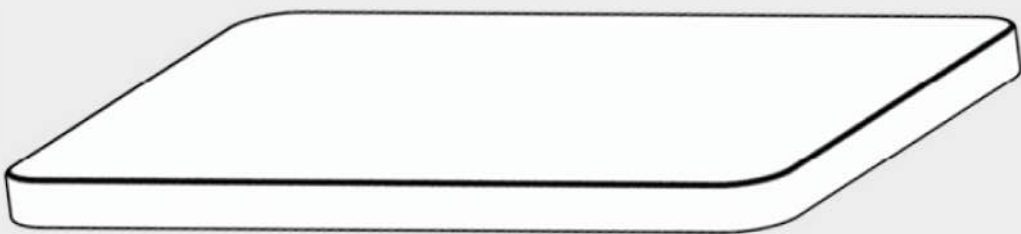



Installation & Assembly

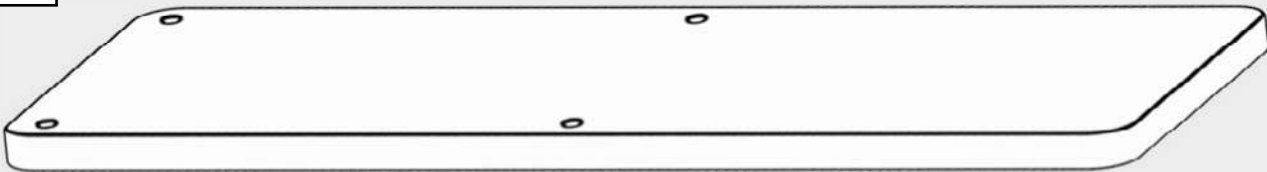

In order for warranty conditions to be valid, please follow the instructions on the manual. For an easy and efficient assembly, we recommend placing all the parts on a flat surface and reading the manual carefully. Once placed, match all the parts with the instruction manual

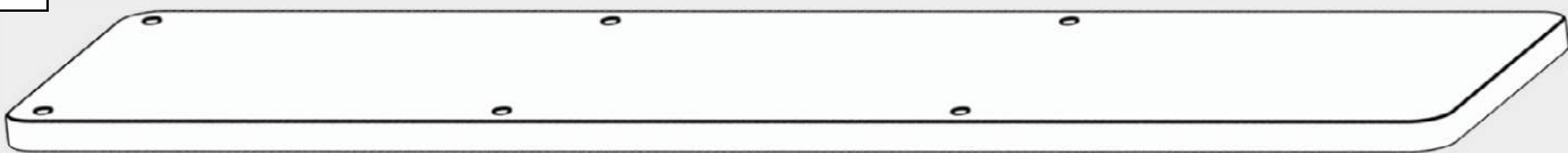
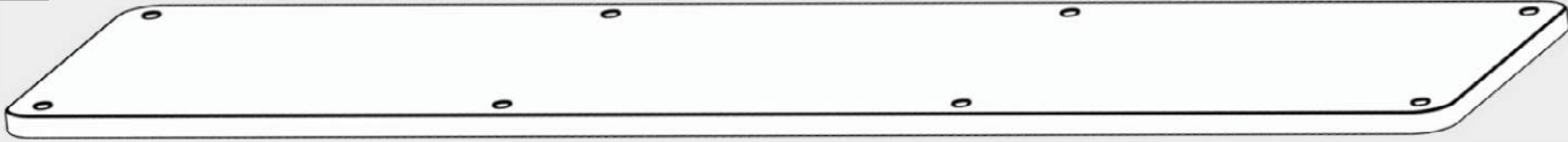
Part List		Part No	Piece
1		1	1
			x8
3		4	10
			
5			x1
6			x
7		8	x8
			x8

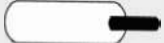
Step 1 Remove the protective caps before assembly.



Step 2 ↘

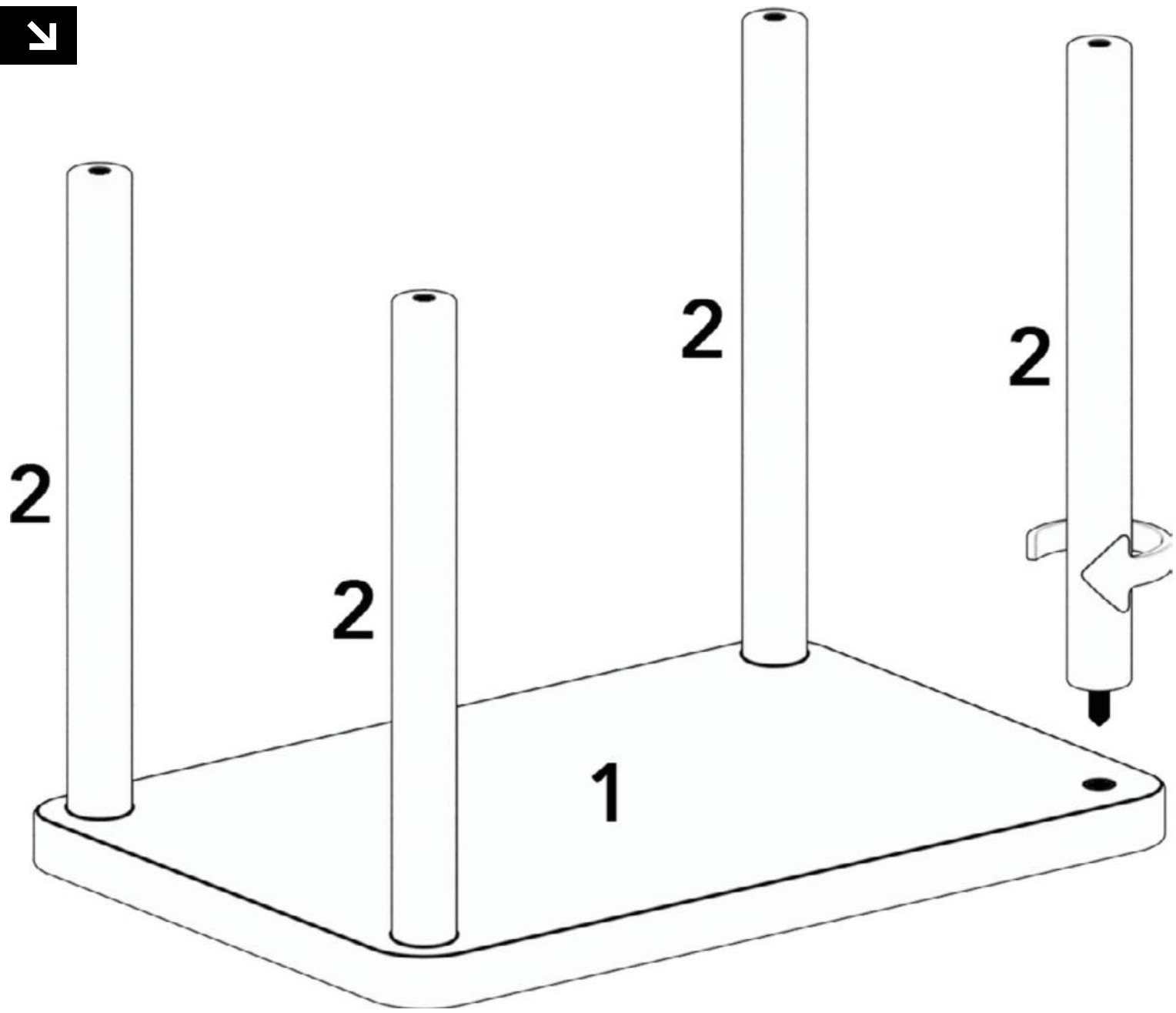

Step 3 ↘

