

Convertible Chair Bed

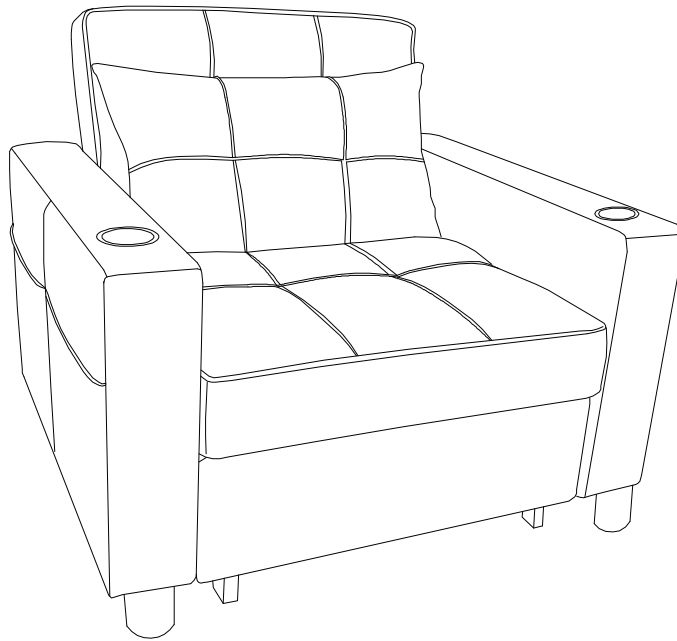

Attention

Thanks for choosing our product.







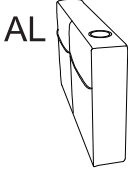
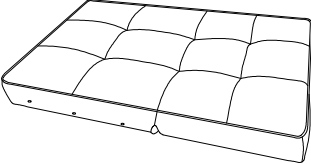
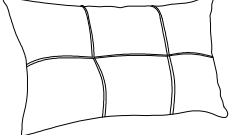

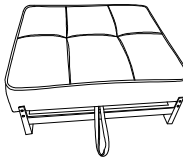
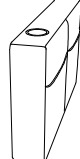

1. There will be two boxes in total for this whole product. Before assembling, please check you receive all the parts listed below. If there is any missing or damaged part, or if you have any question, please feel free to contact our service team for help.
2. Two persons are recommended to assemble the set.
3. Recommend to use waterproof furniture cover for entire furniture set when it is used outdoor to keep them longer lifetime.
4. Sofa cushion covers can be removed and cleaned up by cleaner when there are stains.

Parts List

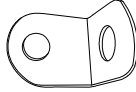
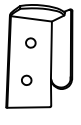
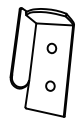
BoxA

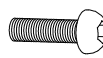
<p>A</p>  <p>AL</p> <p>1pc</p>	<p>C</p>  <p>1pc</p>	<p>D</p>  <p>1pc</p>
--	--	--

BoxB

<p>B</p>  <p>1pc</p>	<p>E</p>  <p>1pc</p>		
<p>F</p>  <p>1pc</p>	<p>G</p>  <p>AR</p> <p>1pc</p>	<p>H</p>  <p>4pcs</p>	
<p>I</p>  <p>4pcs</p>	<p>J1</p>  <p>1pc</p> <p>J2</p>  <p>1pc</p>	<p>K</p>  <p>M6*20 8pcs</p>	<p>L</p>  <p>M6*30 8pcs</p>
<p>M</p>  <p>M8*60 6pcs</p>	<p>N</p>  <p>M6 16pcs</p>	<p>O</p>  <p>M8 6pcs</p>	<p>P</p>  <p>1pc</p>

Assembly Guide

STEP 1

Please follow the accessories direction in the figure for installation.

		2
J		2
L		4
N		4
P		1

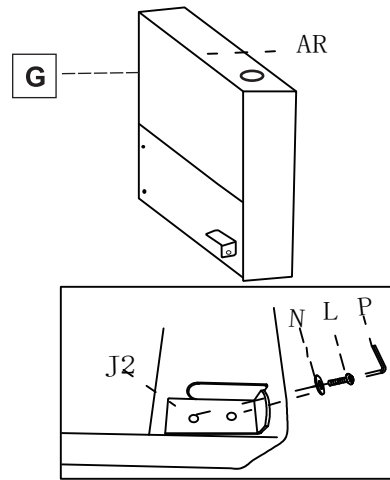
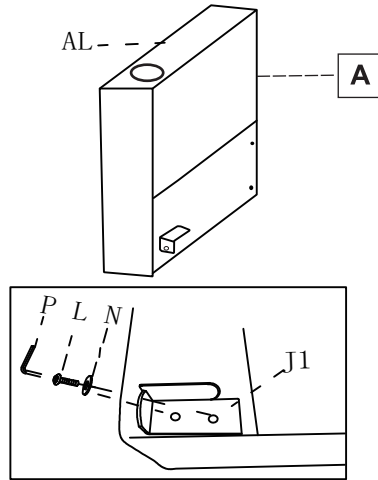

STEP 2

Put the screws into the holes one by one. Please do not lock any one of the 3 screws before they are all aligned. After aligning them all and then tighten them with an electric screwdriver.

AL		1
C		1
M		3
O		3
P		1

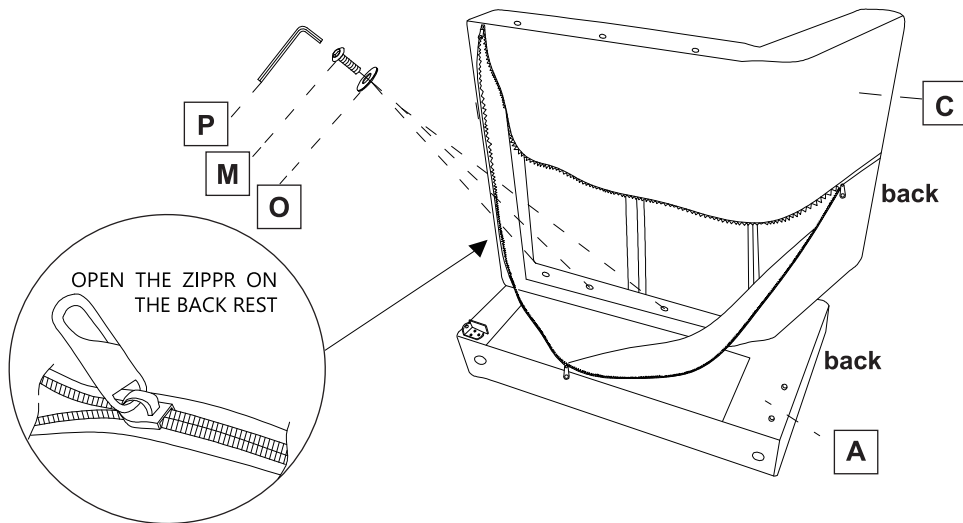



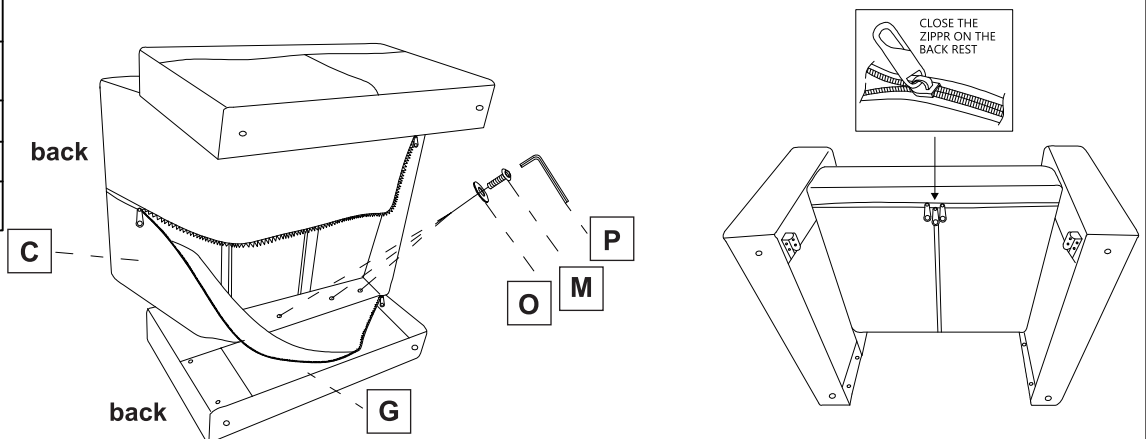

STEP 3

AR		1
C		1
M		3
O		3
P		1



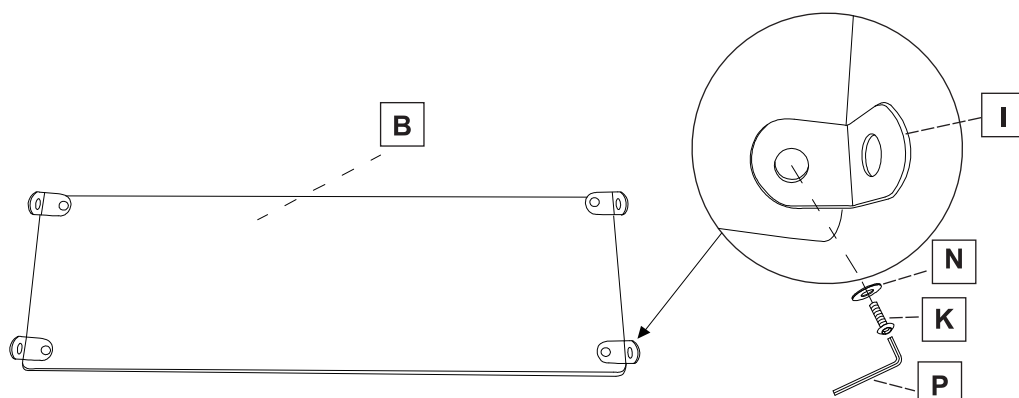

STEP 4

B		1
I		4
K		4
N		4
P		1



STEP 5

L		4
N		4
P		1

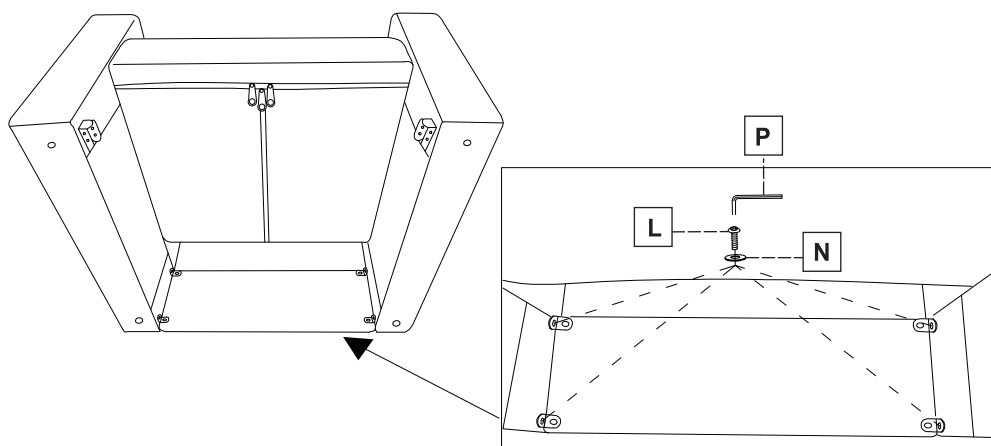



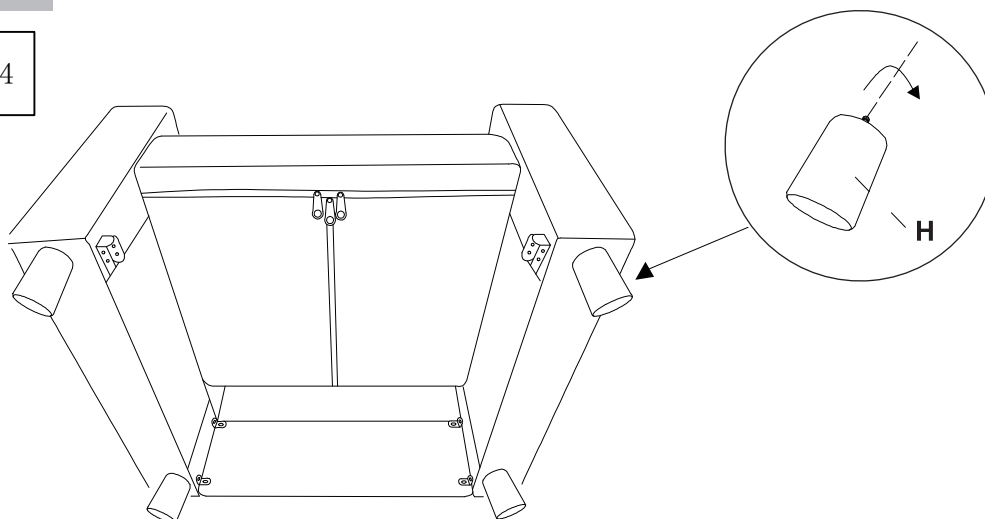

STEP 6

H		4
---	---	---



STEP 7

F		1
E		1
K		4
N		4
P		1

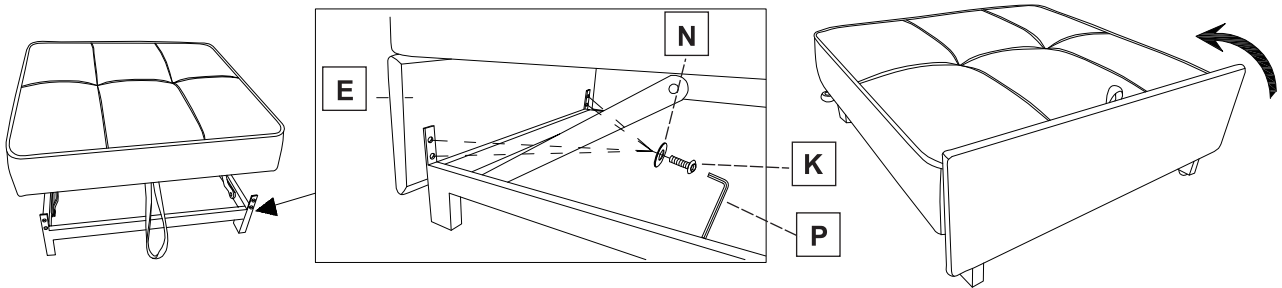
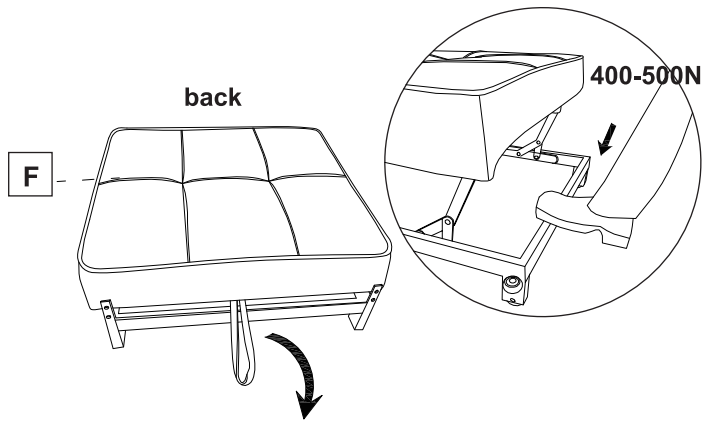

STEP 8

Please pay attention to the part K installation direction, this part is not next to the bottom, but 3.9" height from the ground.

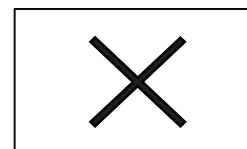
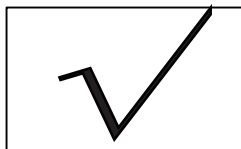
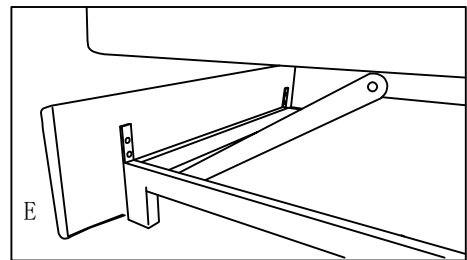
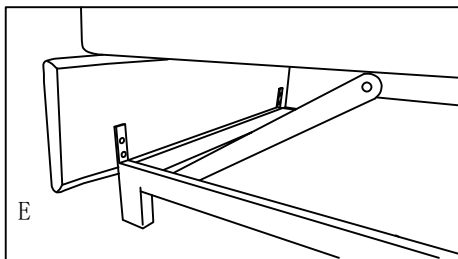
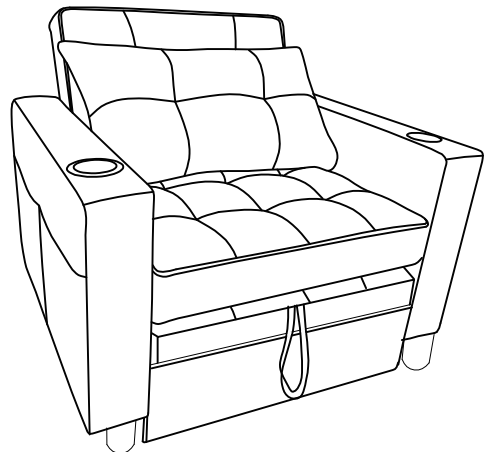
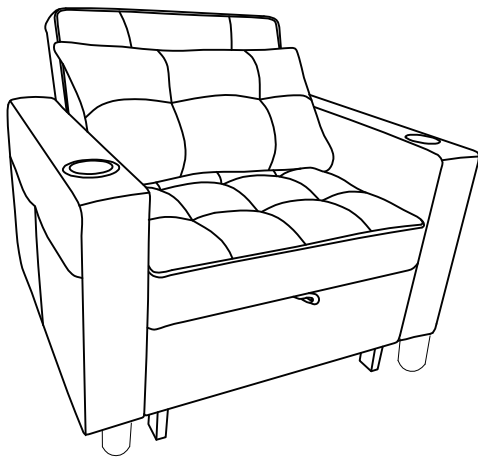

STEP 9

