

HAYLEEN ROUND CONCRETE COFFEE TABLE

DESIGN # SFV2603

Assembly Instructions

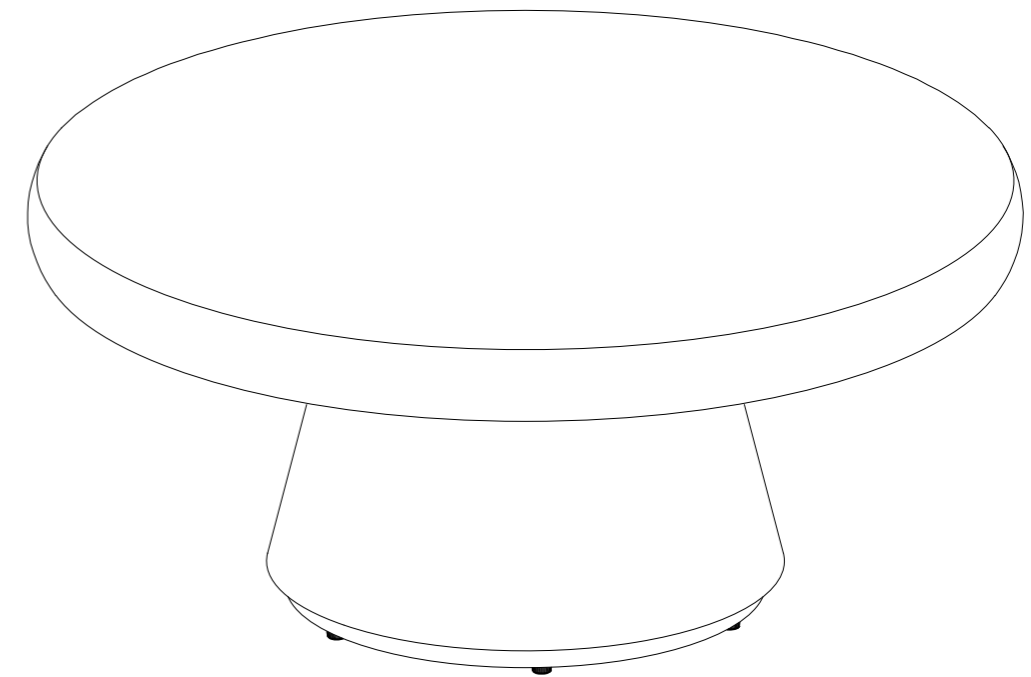

Need help?

Feel free to contact us via email or call
if you have any specific questions!

contact us:

cs@safavieh.com
866-422-9070

SAFAVIEH
C O U T U R E

Thanks for bringing Safavieh Couture into your home

Everything we make is incredibly simple to set up , including your Coffee Table. You won't need any additional tools.

Parts List:

A x 1
TOP

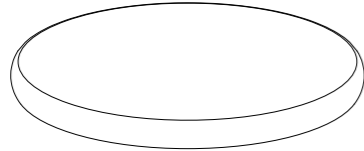

B x 1
FRAME

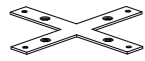

C x 1
BASE

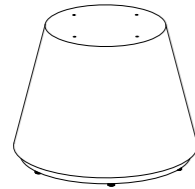

Hardware List:

HW1 x 8
Bolt M6x15mm



HW2 x 1
Allen Key M4



Assembly completed.

Adjust the levelers on the bottom of the legs as needed to make the table level. Place the table in the place where you will use it. We'd love to see it - just tag us (we're @safavieh) and use the hashtag #safavieh on Instagram!

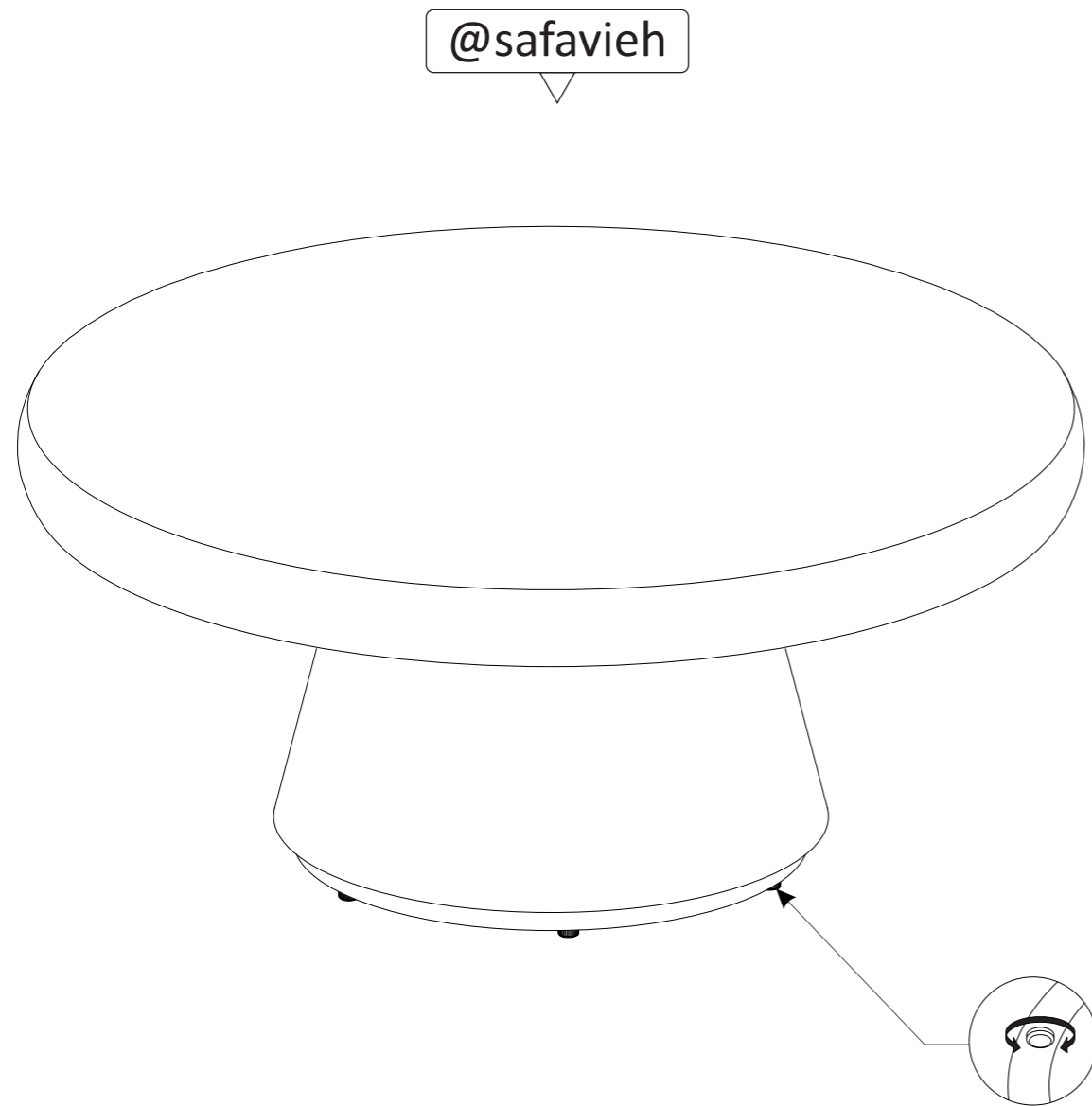

1

Place the table top (A) upside down on a soft surface. Remove the frame (B) from the table top (A) by using the Allen Key (HW2) to remove the bolts (HW1).

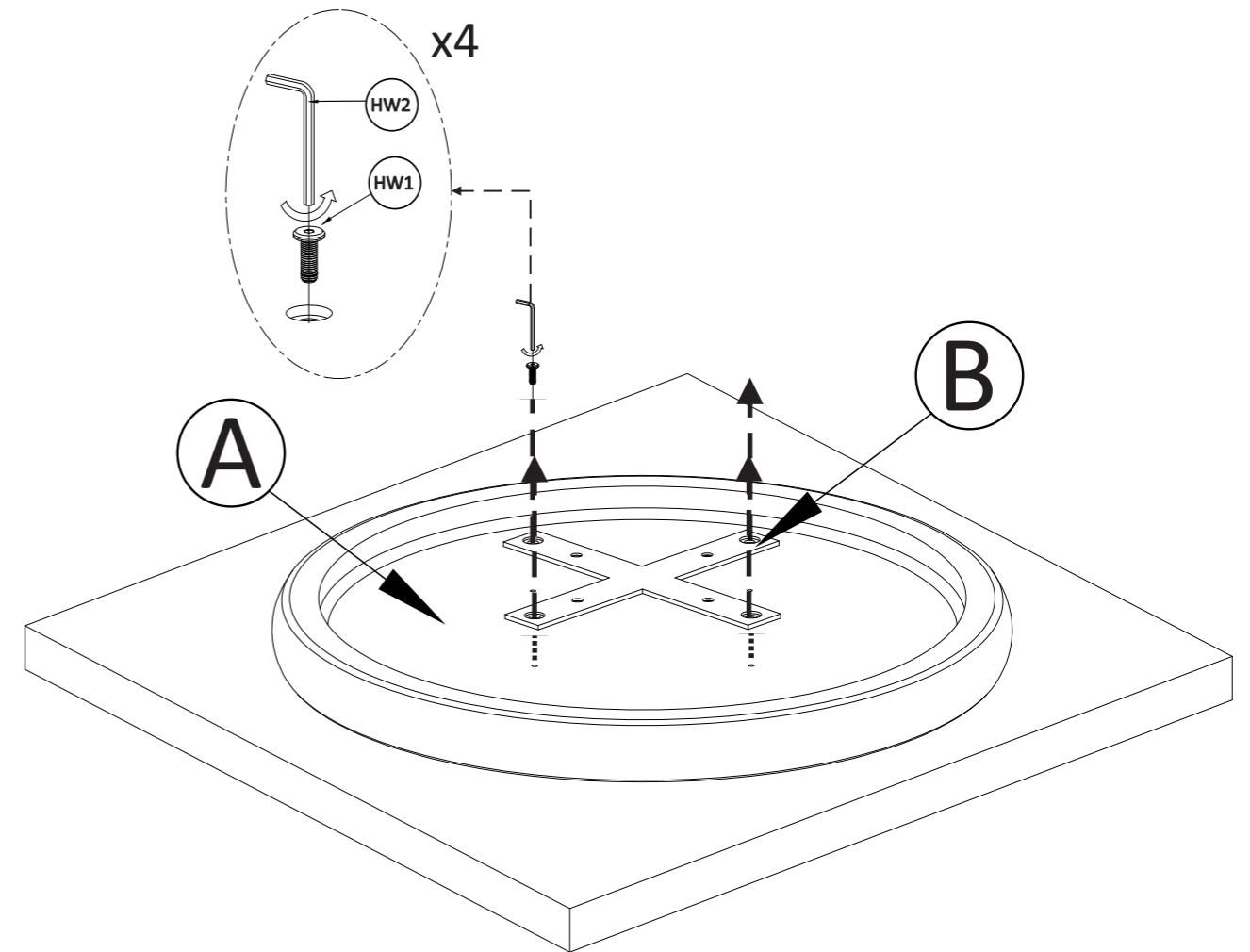

Use foam in the box to protect the top when assembling the product.

2

Attach the frame (B) to the base (C) by using the Allen key (HW2) to screw in the bolts (HW1) as shown.

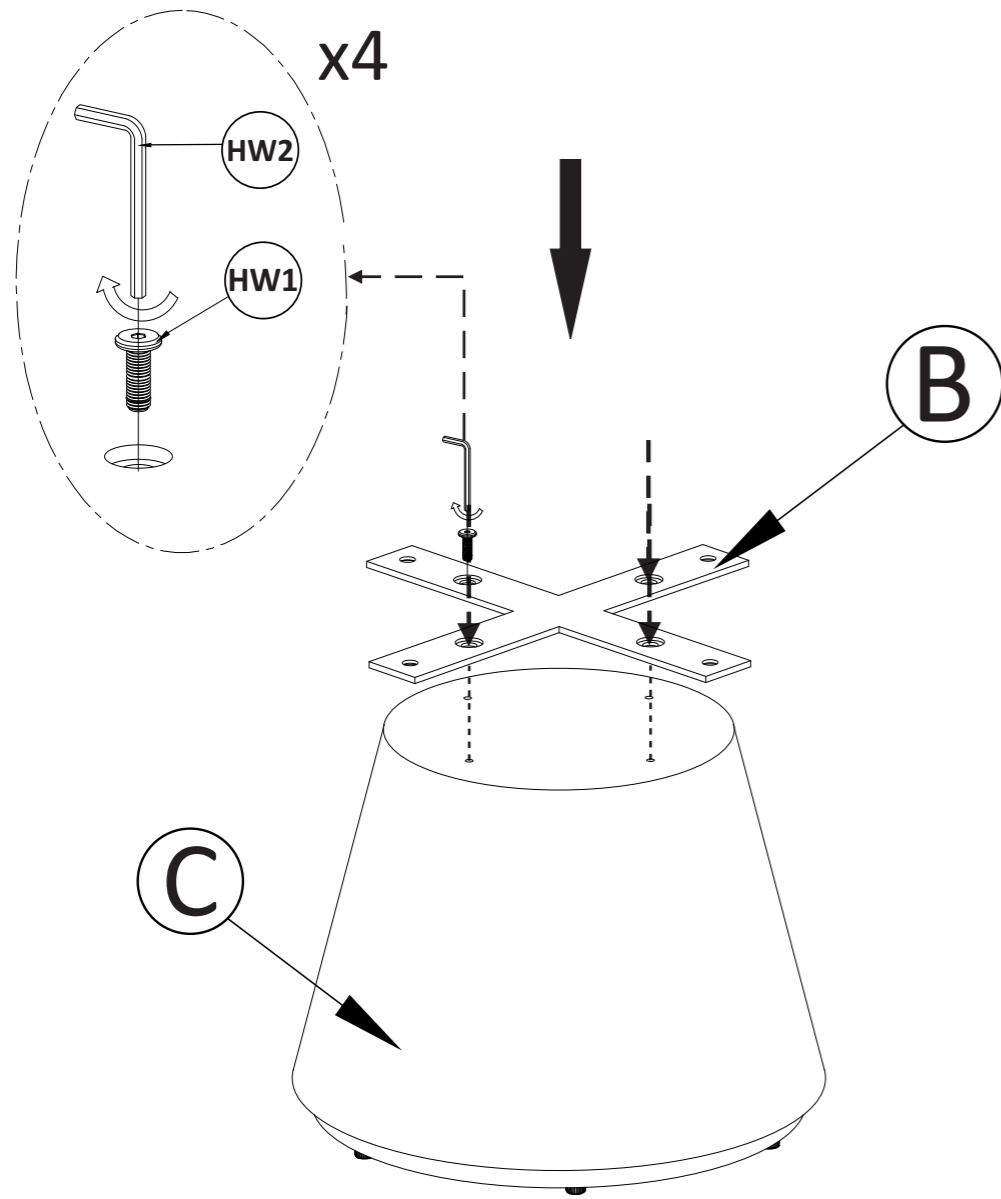

3

Attach the table top (A) to frame (B) by using the Allen key (HW2) to screw in the bolts (HW1) as shown.

