

MANUAL INSTRUCTION

TV STAND

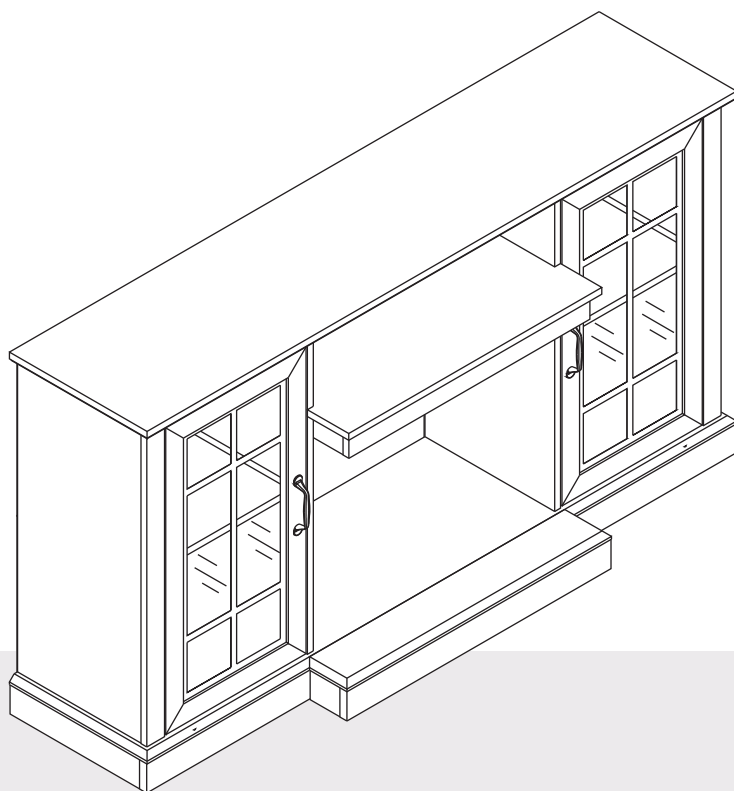

We offer a diverse range of products to
meet the needs of customers.

Indoor Furniture

We are a professional furniture provider with top-notch factories and outstanding designs, Our mission is to provide consumers with new lifestyles. By collecting consumer feedback, we constantly improve our products and create more choices for consumers. If you want to create your space, We are an ideal choice.

Always.



WARNING

All the TV Stands have passed strict quality inspections before delivery . Read this manual carefully to ensure proper usage

Ensure that all parts and hardware are available before beginning assembly

NOTICE

1. Children are not allowed to operate.
2. Faster installation is possible with power tools.
3. Do not pull the door vigorously to prevent the storage cabinet from tipping over.
4. Please attach the storage cabinet to the wall with an anti-tip device after installation is complete.
5. When using the storage cabinet for the first time, please keep it in a ventilated environment to allow the smell to fully evaporate.
6. When placing the partitions, please make sure the nails are firmly installed to prevent the partitions from falling off.
7. If any parts are missing, broken, damaged or worn, discontinue use of the product until repairs are made and/or factory replacement parts are installed.
8. Do not use this product in a manner inconsistent with the manufacturer's instructions, as this may void the product warranty.
9. If accessories are missing, please contact customer service for communication in time, we provide 7x24 hours customer care.
10. Do not use any attachments or accessories other than the original factory attachments and accessories.
11. Do not alter this equipment. Any alteration will create a safety hazard.

WARNING

The product must be assembled by adult before use. Serious or fatal injury may occur from unexpected assembly or use.

1. During the assembly process, keep all parts away from babies or children.
2. Always securely fix this product to the wall. Make sure the wall area to be drilled is free from hidden electrical wires, water and gas pipes.
3. Use of tip-over restraints may only reduce, but not eliminate the risk of tip-over.
4. Unless specially designed to accommodate, do not set heavy objects on top of this product.
5. Place the heaviest items on the lowest shelf.
6. Never allow children to climb or bang on drawers, doors or shelves.

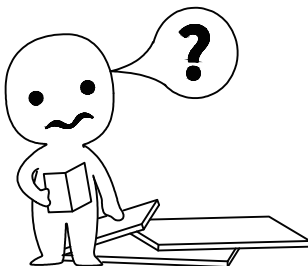
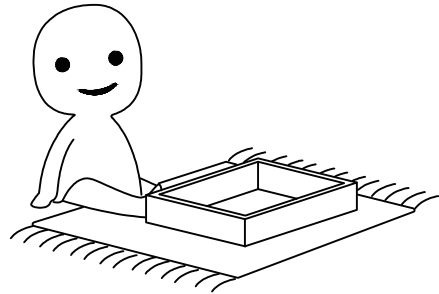
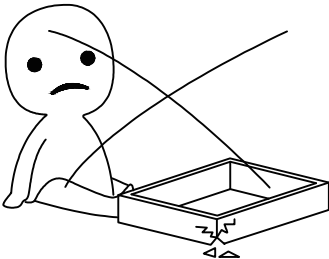
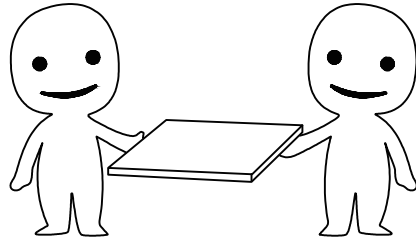
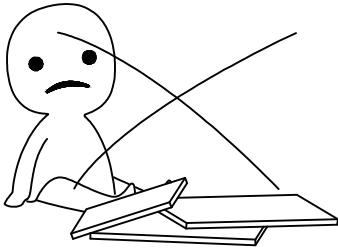
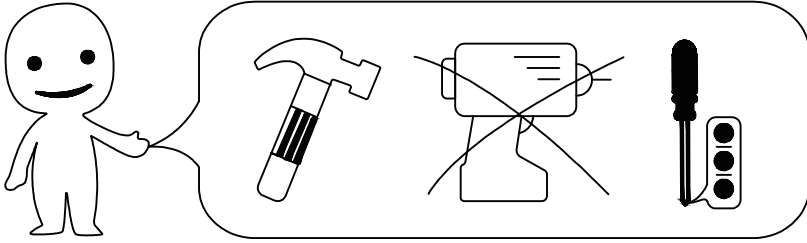

- DE**
Wichtige Information
- Sorgfältig und aufmerksam lesen
 - Diese Information aufbewahren
- GB**
Safety information
- Important information
 - Please read closely and carefully
 - Save this information

BEFORE YOU START

- Separate and count all parts and hardware.
- Have the following tools: Flat head Screwdriver, #2 Philips Head Screwdriver.
- If using a power tools, please be ware to slow down and stop when screw is tight. Failure to do so may result in stripping the screw.
- Requires two people for assembly.

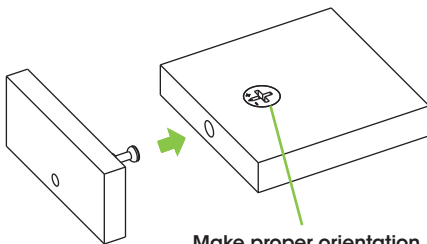
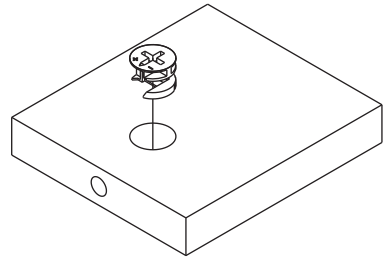
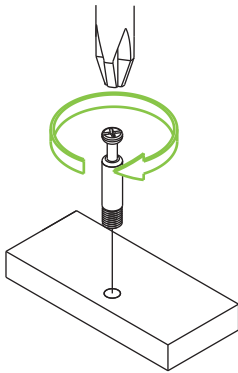
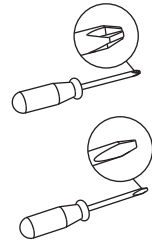

Make proper orientation
of CAM LOCK when
inserting CAM PIN

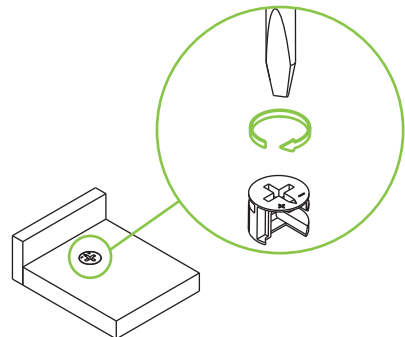

TOOLS REQUIRED



PHILLIPS
SCREWDRIVER



2Persons Assembly



Minimum 60 Minutes For Assembly

HARDWARE

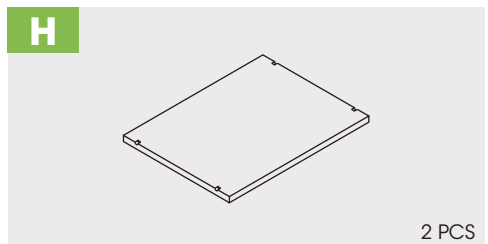
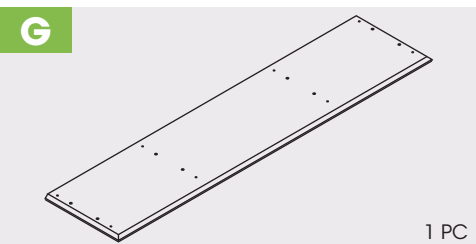
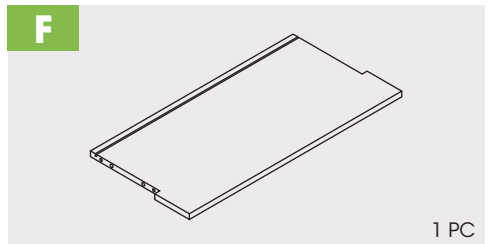
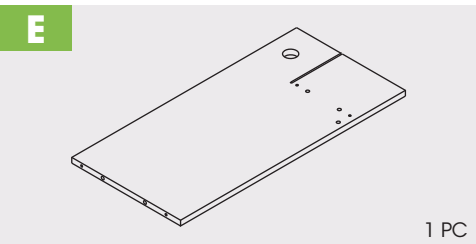
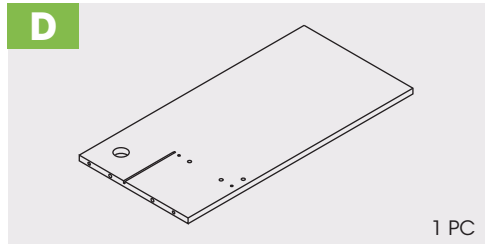
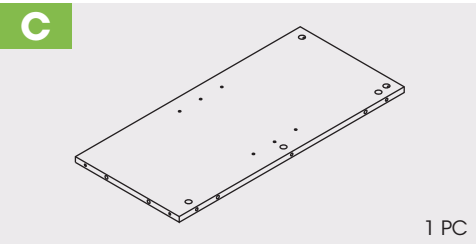
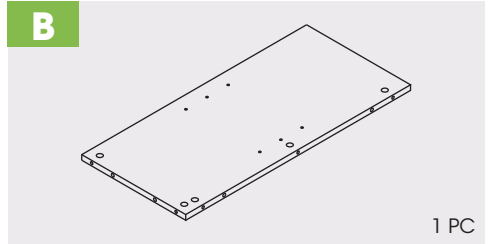
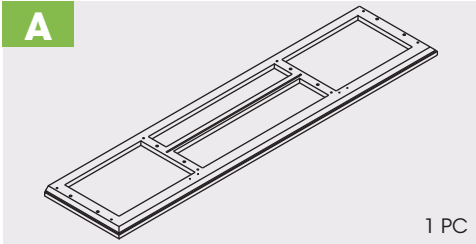

HARDWARE

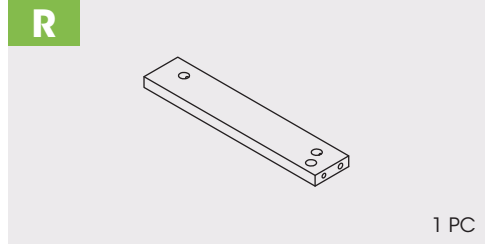
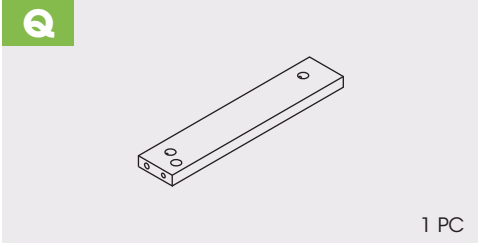
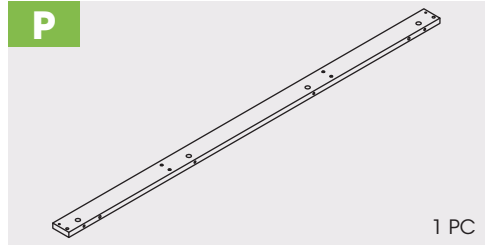
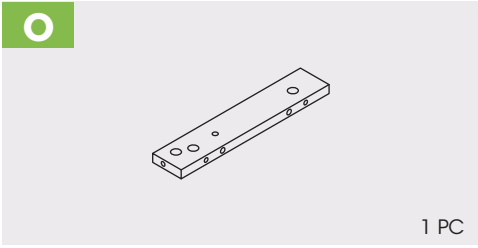
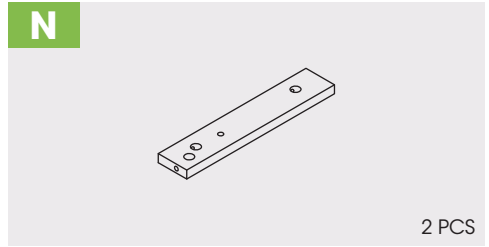
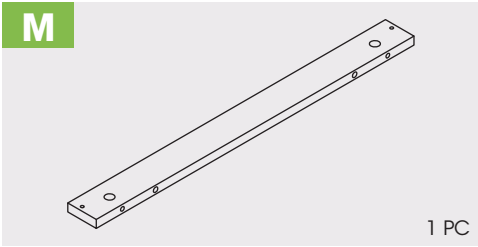
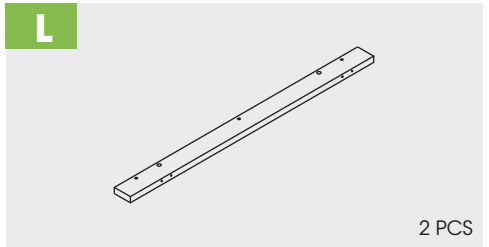
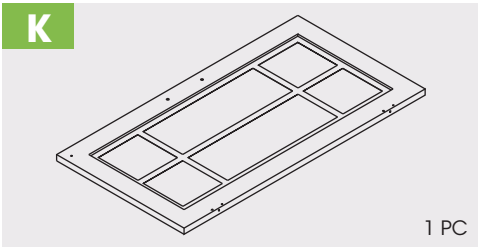
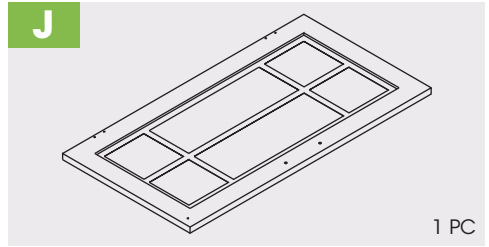
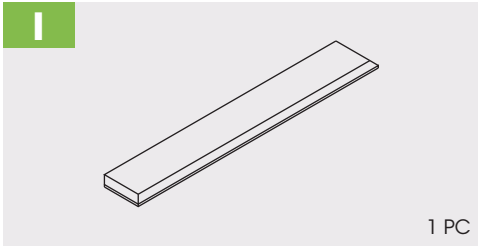

HARDWARE

S

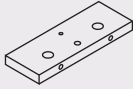

1 PC

T

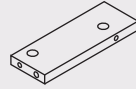

1 PC

U

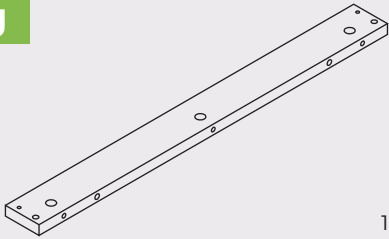

1 PC

V



1 PC

W



1 PC

X

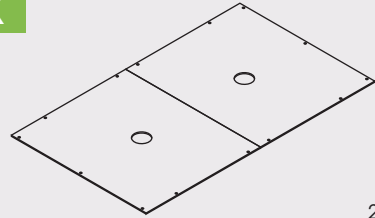

2 PCS

Y

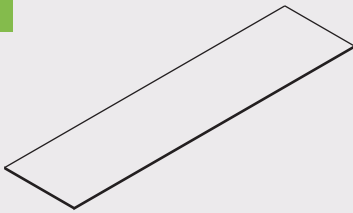

1 PC

PARTS

1

ϕ 15x9.5mm

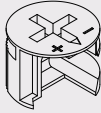

47 PCS

2

ϕ 6.5x35mm

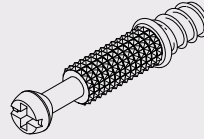

47 PCS

3

ϕ 8x30mm

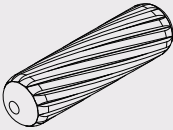

43 PCS

4

ϕ 6.3x50mm

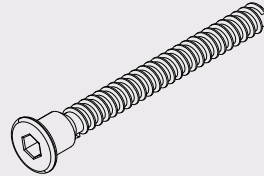

8 PCS

5

M6x25mm

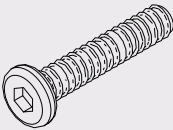

2 PCS

6

ϕ 3.5x14mm

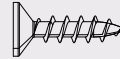

30 PCS

7

ϕ 3x14mm



28 PCS

8

ϕ 4x40mm

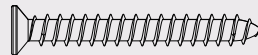

4 PCS

9

M4x18mm

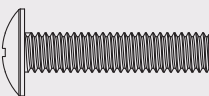

4 PCS

10

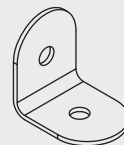

2 PCS

PARTS

⑪ M6x25mm

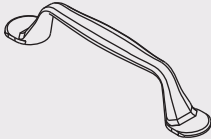

2 PCS

⑫

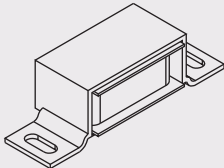

2 PCS

⑬

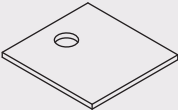

2 PCS

⑭

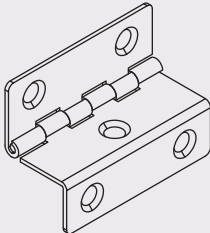

4 PCS

⑮ 4x65mm

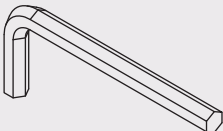

1 PC

⑯

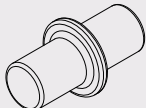

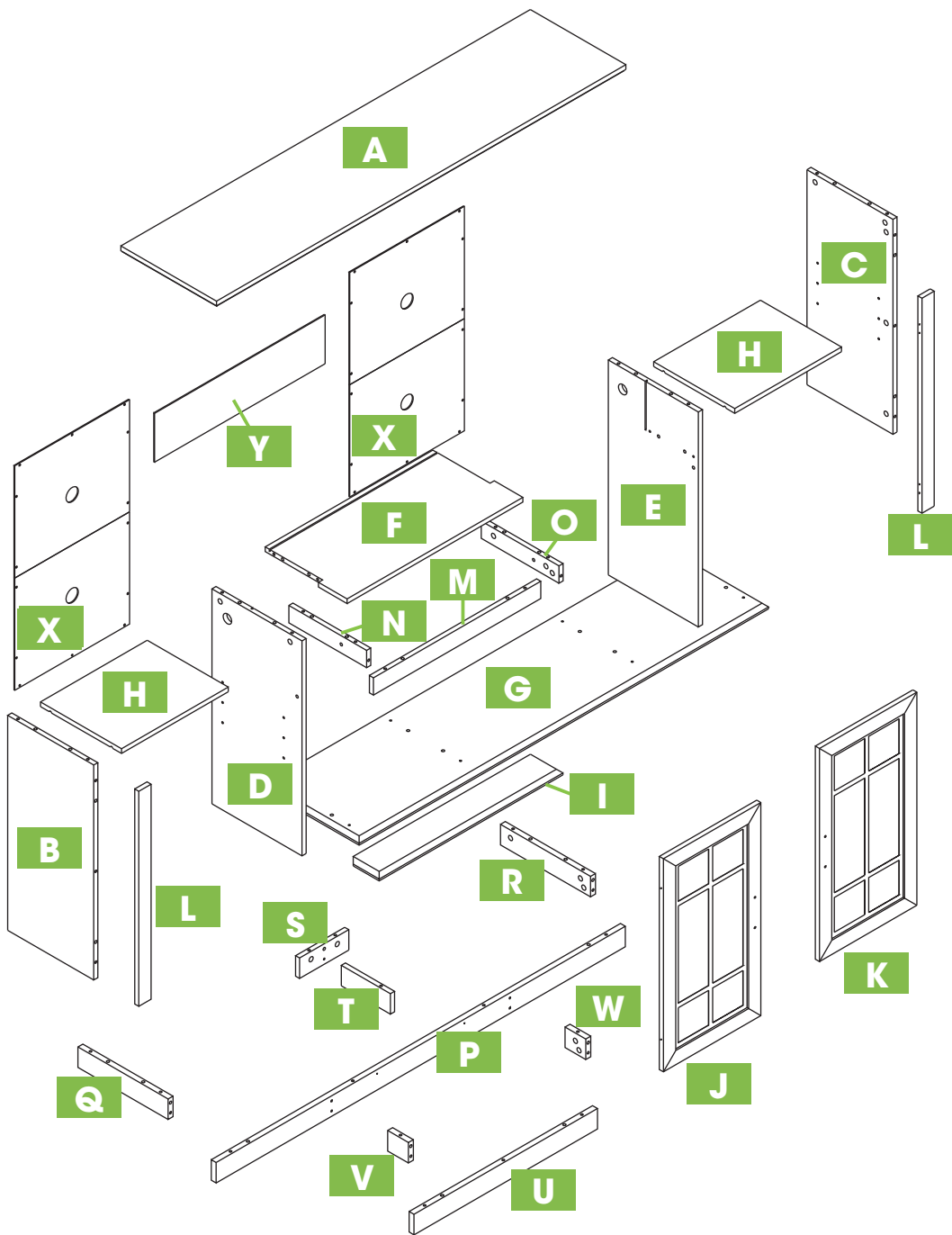

8 PCS



PRODUCT ASSEMBLY

1

| PART | NO. | QTY. |
|---|-----|------|
|  | ② | 6 |
|  | ③ | 12 |

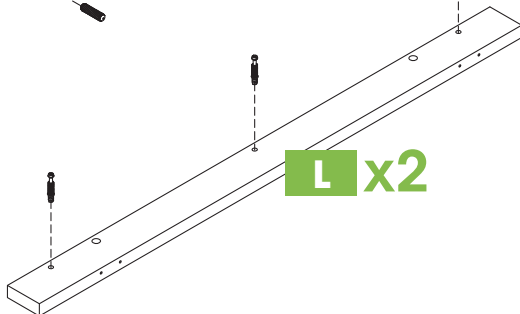
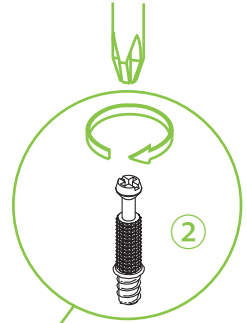
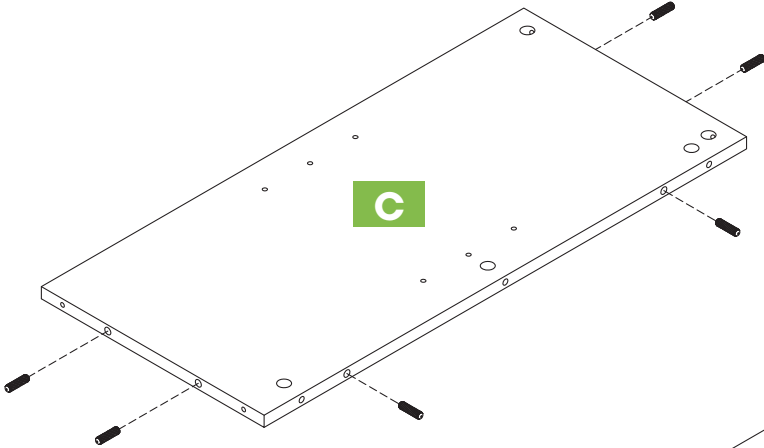
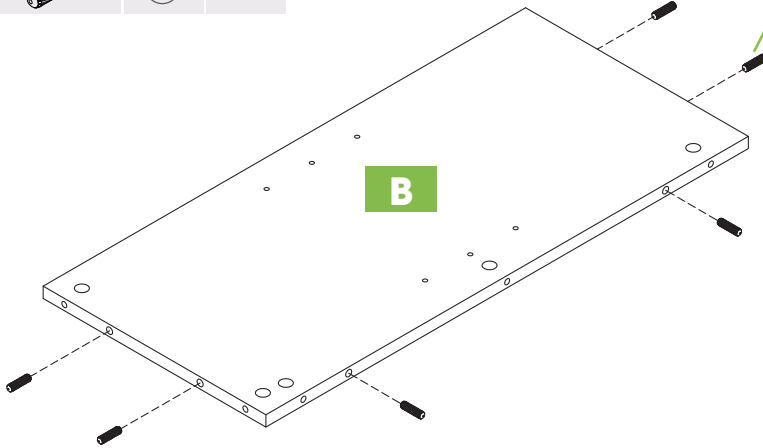
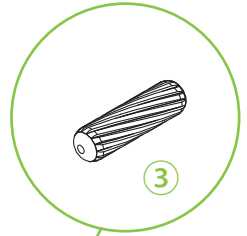

PRODUCT ASSEMBLY

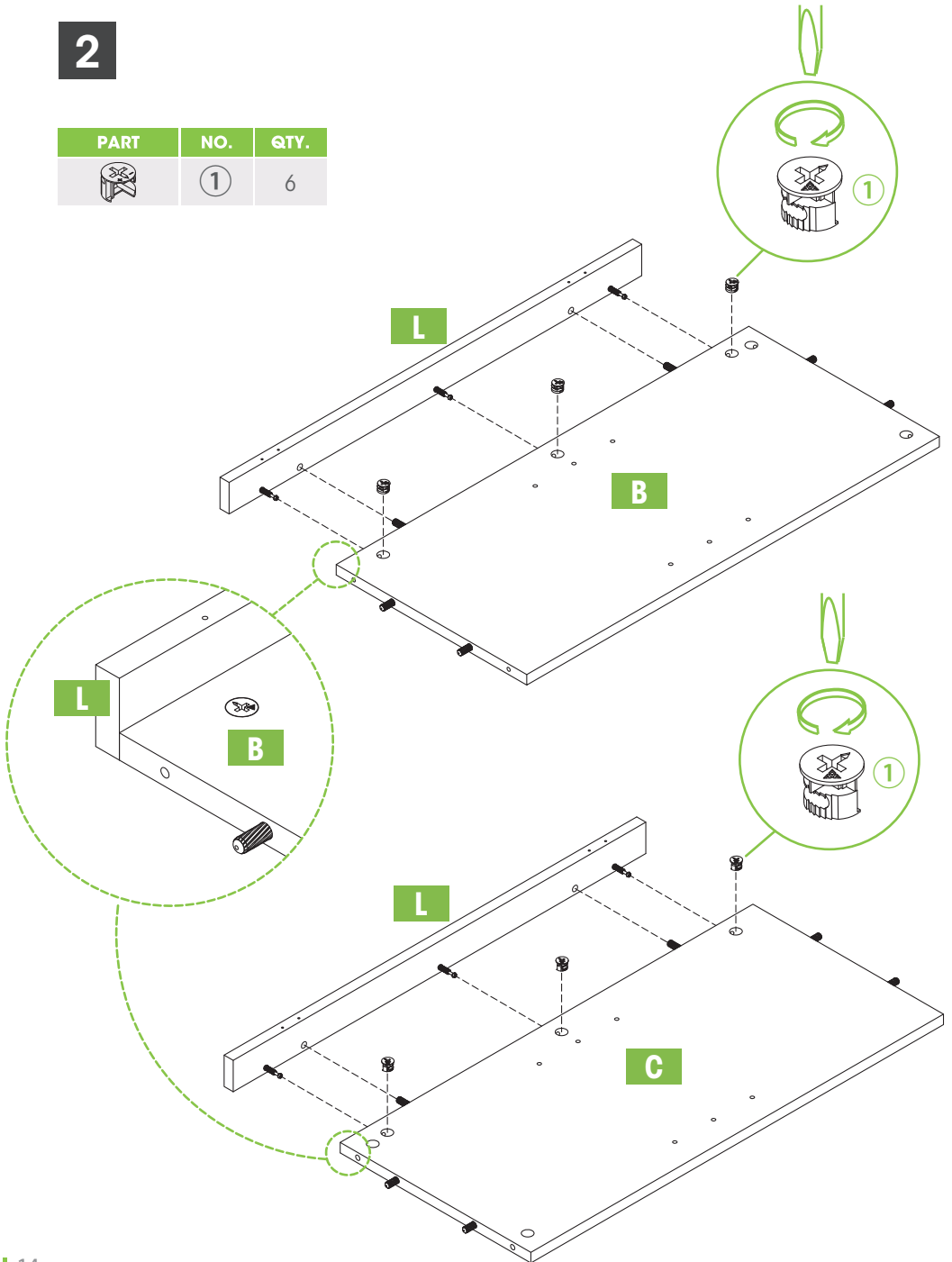

2

| PART | NO. | QTY. |
|---|-----|------|
|  | 1 | 6 |



PRODUCT ASSEMBLY

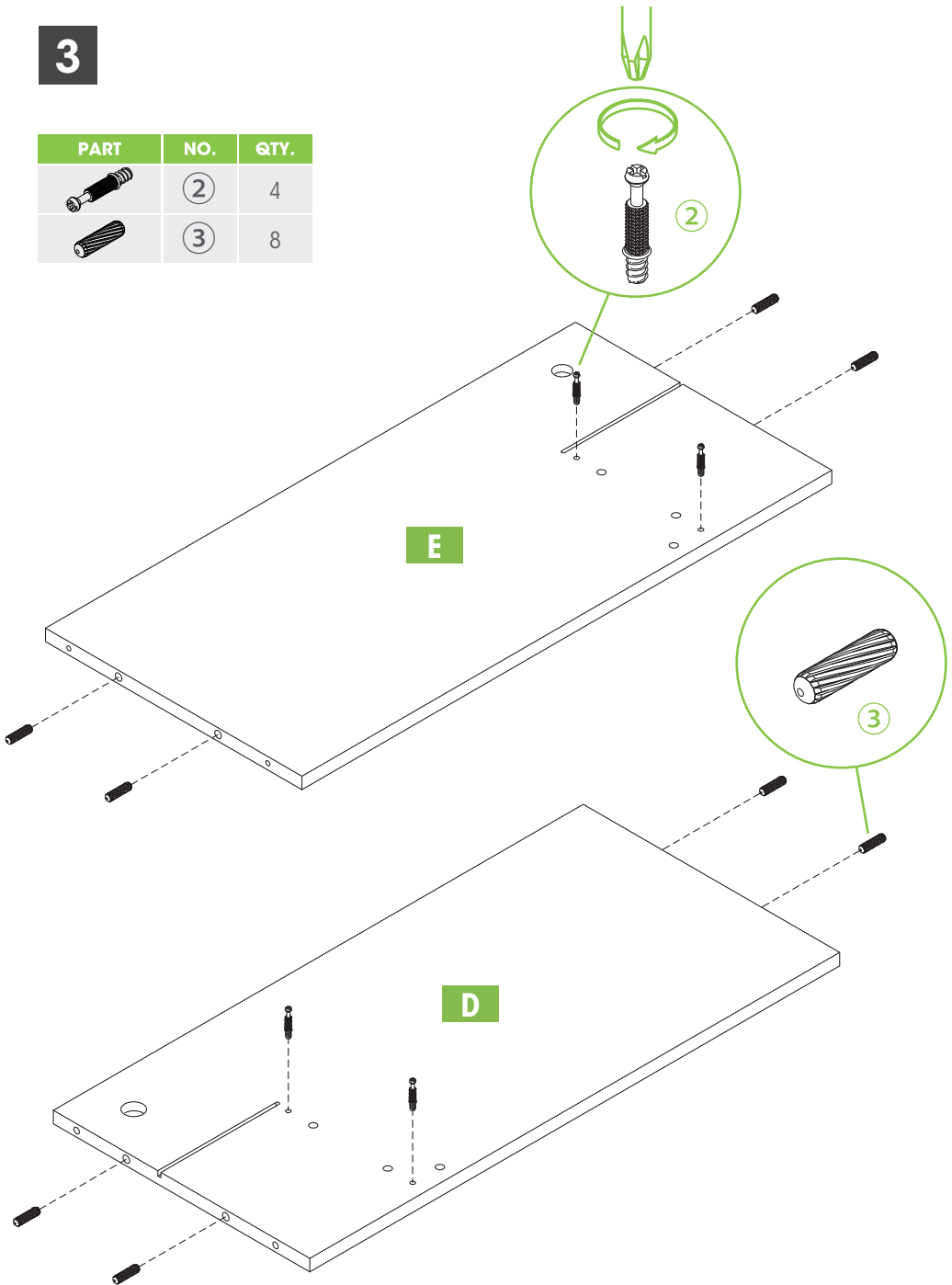

3

| PART | NO. | QTY. |
|---|-----|------|
|  | ② | 4 |
|  | ③ | 8 |



PRODUCT ASSEMBLY

4

| PART | NO. | QTY. |
|---|-----|------|
|  | 2 | 8 |
|  | 3 | 10 |

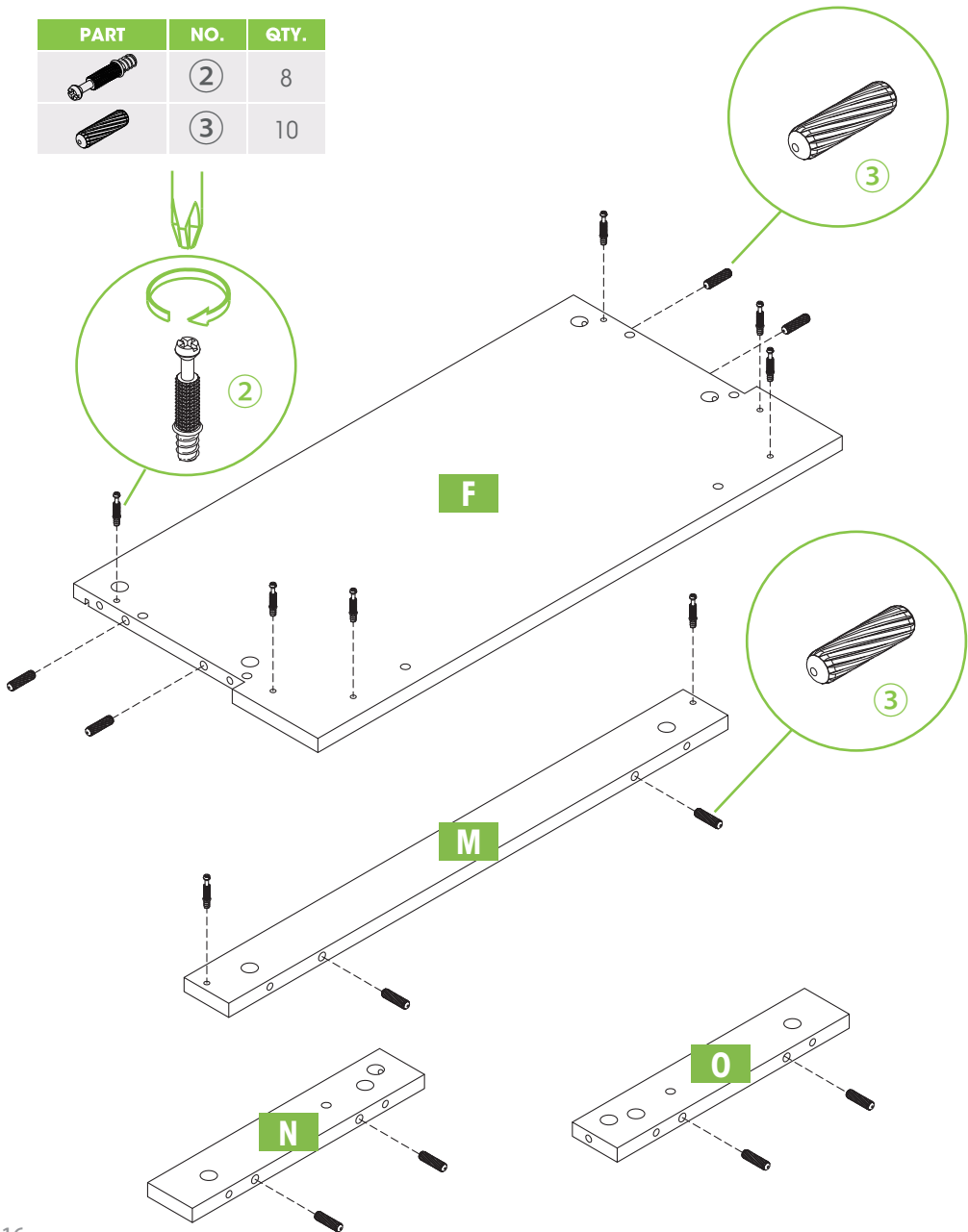

PRODUCT ASSEMBLY

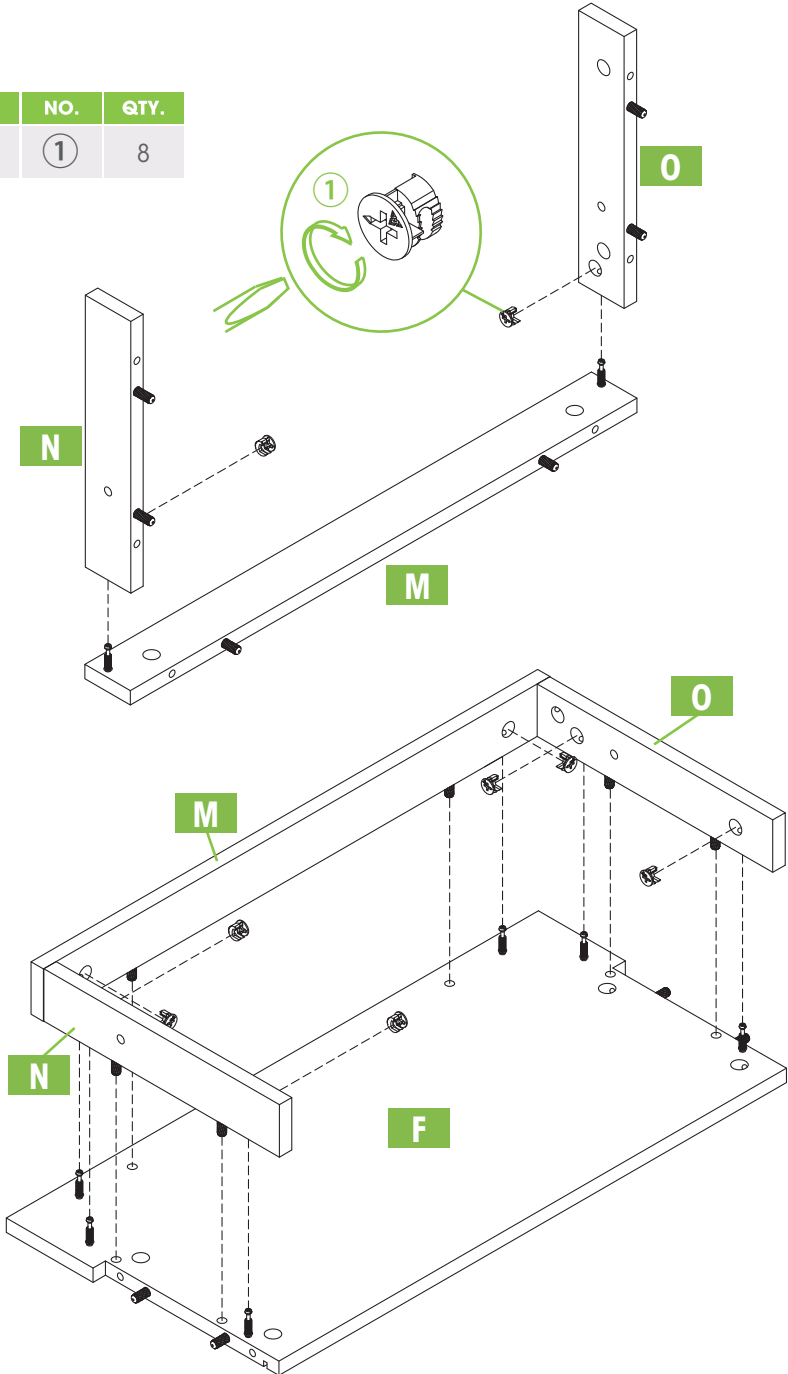

5

| PART | NO. | QTY. |
|---|-----|------|
|  | 1 | 8 |



PRODUCT ASSEMBLY

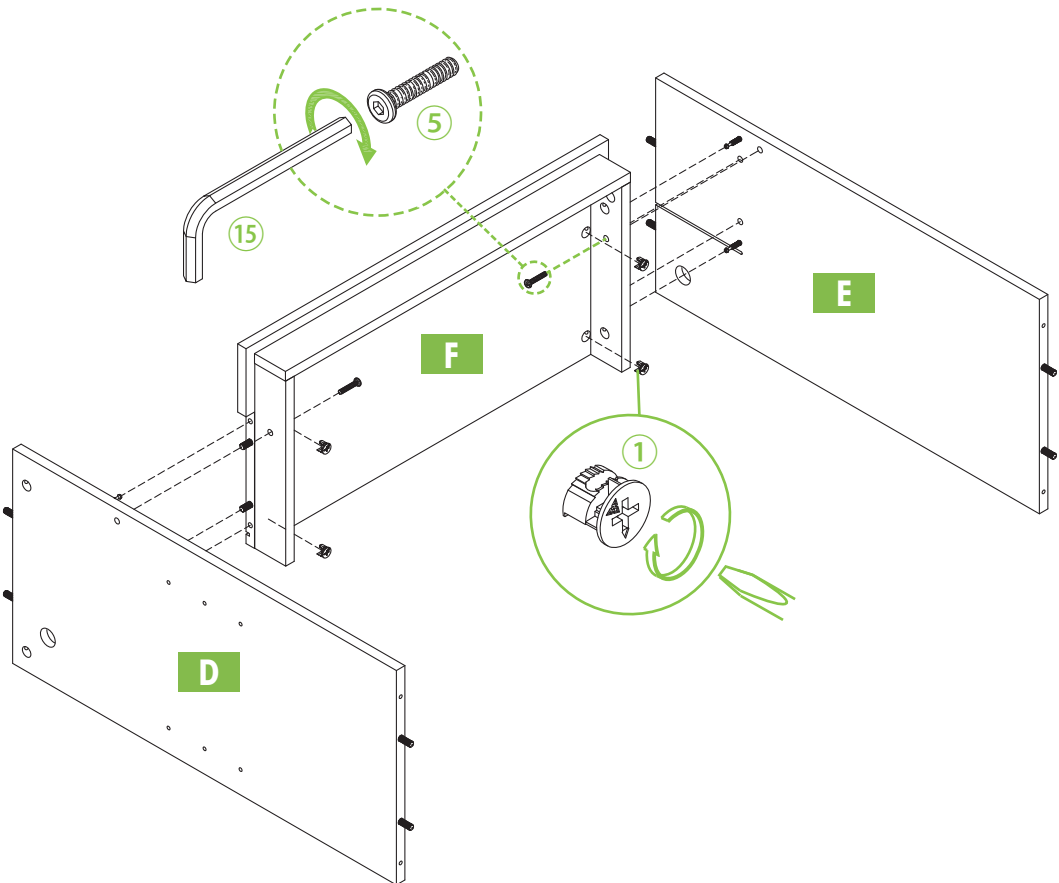

6

| PART | NO. | QTY. |
|---|-----|------|
|  | 1 | 4 |
|  | 5 | 2 |
|  | 15 | 1 |



PRODUCT ASSEMBLY

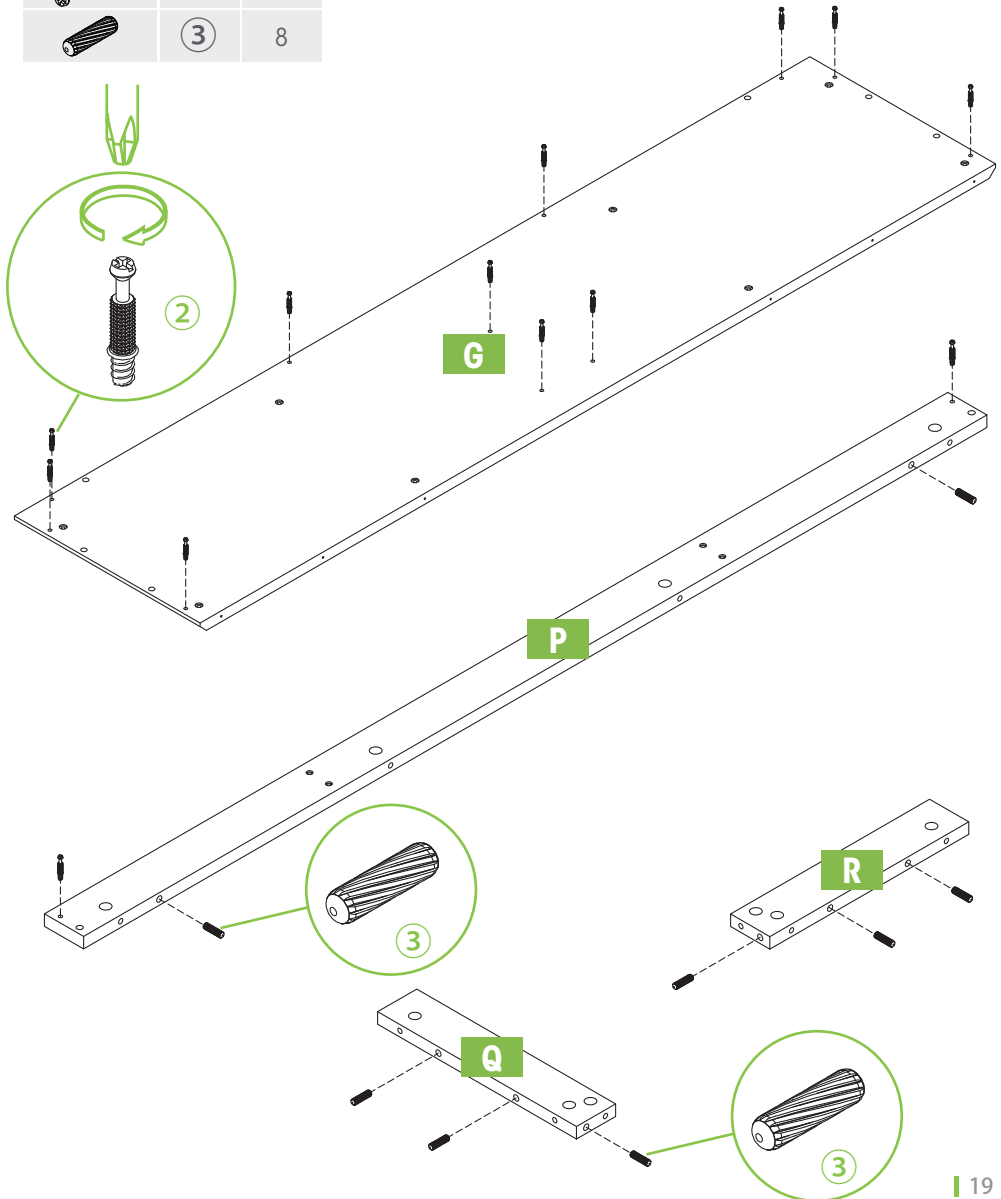

7

| PART | NO. | QTY. |
|---|-----|------|
|  | ② | 13 |
|  | ③ | 8 |



PRODUCT ASSEMBLY

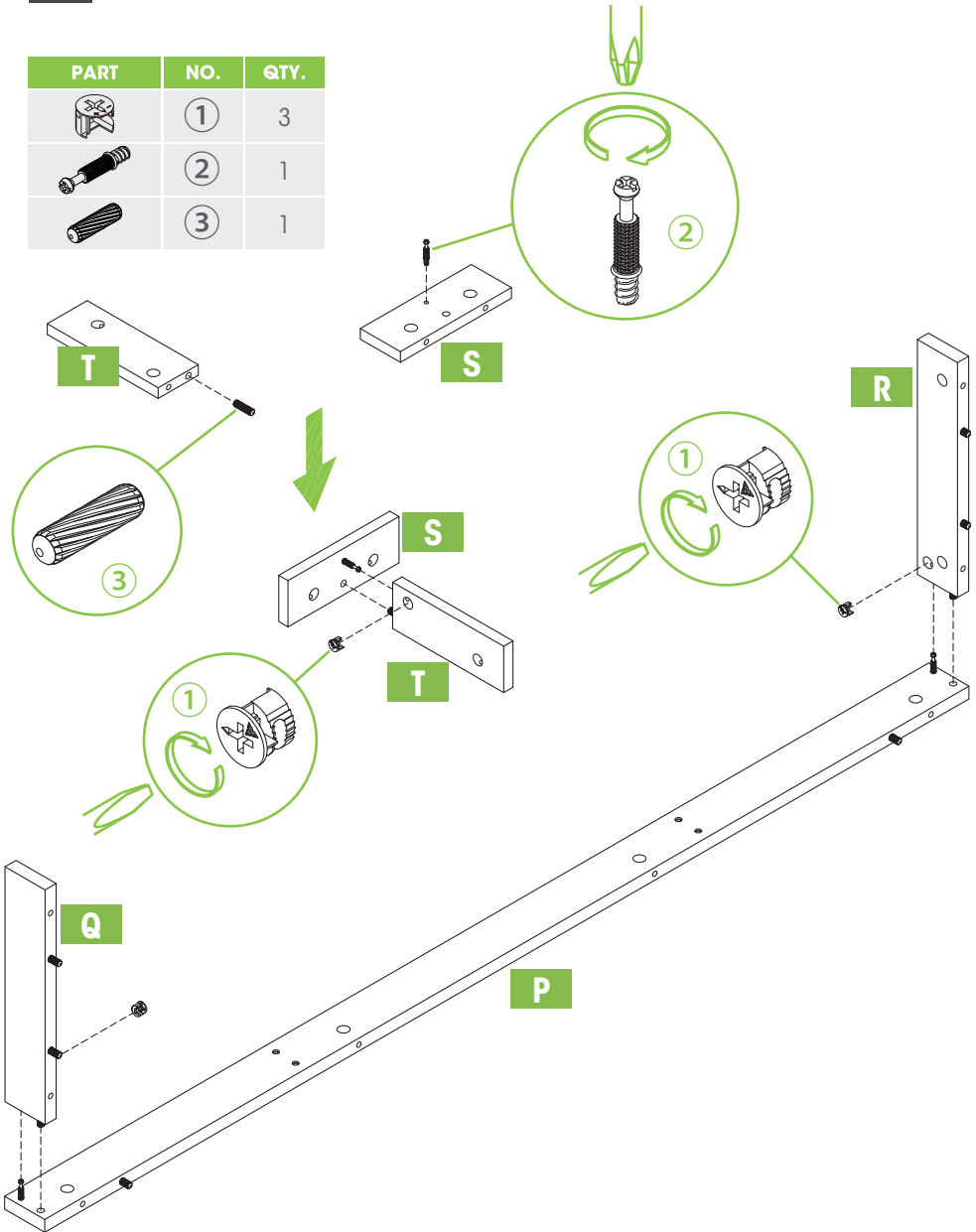

8

| PART | NO. | QTY. |
|---|-----|------|
|  | ① | 3 |
|  | ② | 1 |
|  | ③ | 1 |



PRODUCT ASSEMBLY

9

| PART | NO. | QTY. |
|---|-----|------|
|  | ② | 7 |
|  | ③ | 4 |

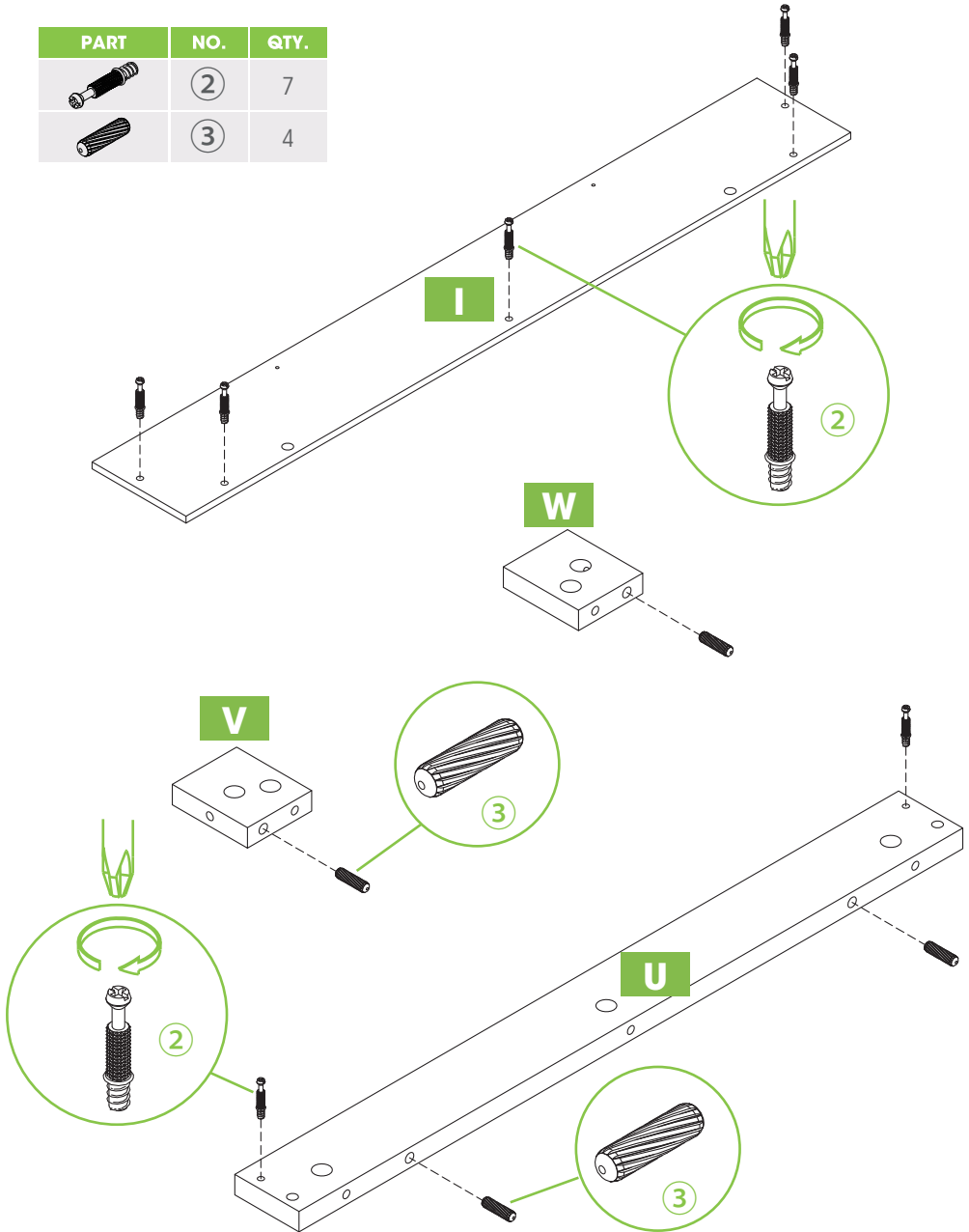

PRODUCT ASSEMBLY

10

| PART | NO. | QTY. |
|---|-----|------|
|  | ① | 11 |

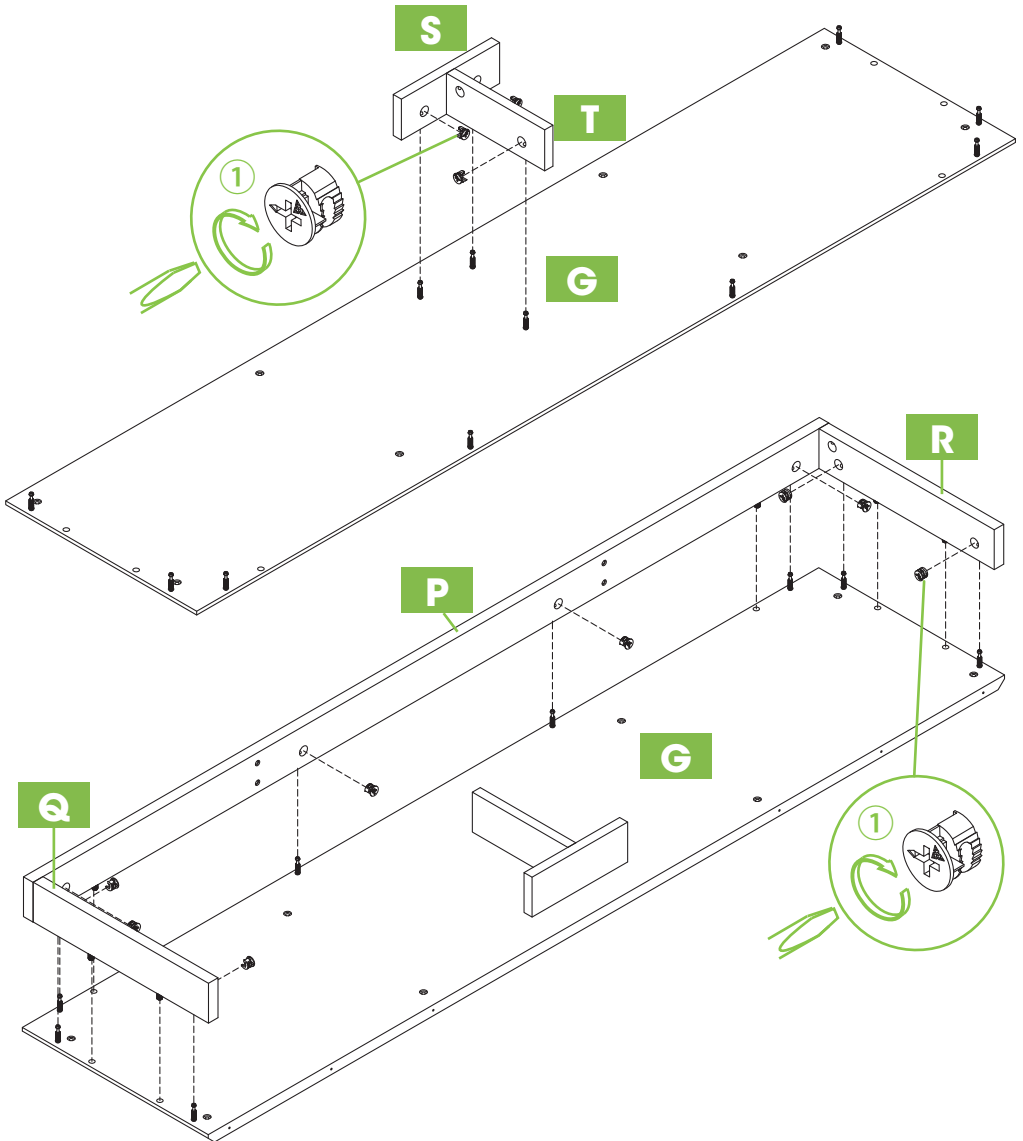

PRODUCT ASSEMBLY

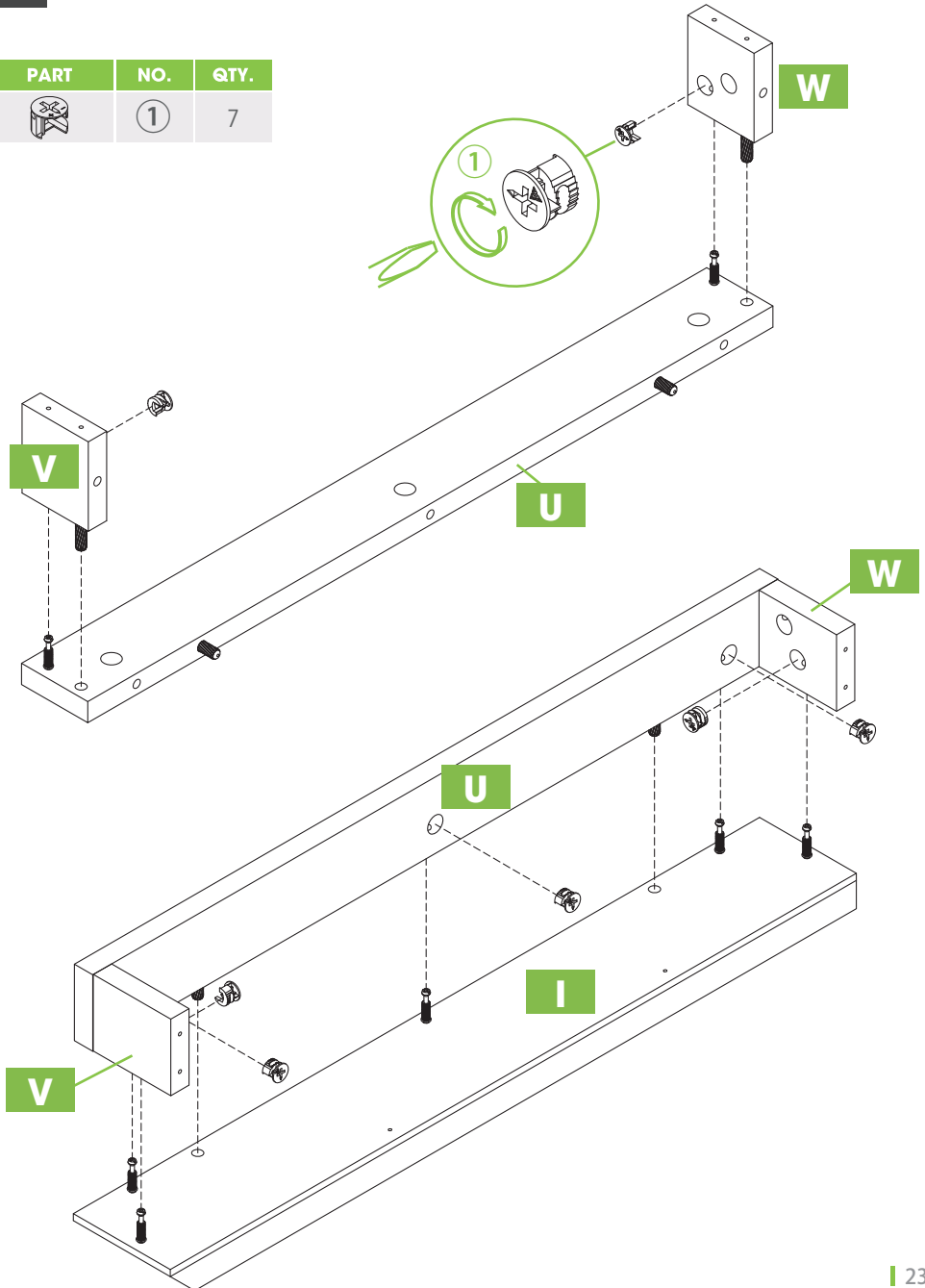

11

| PART | NO. | QTY. |
|---|-----|------|
|  | 1 | 7 |

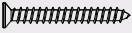

PRODUCT ASSEMBLY

12

| PART | NO. | QTY. |
|---|-----|------|
|  | 6 | 4 |
|  | 8 | 4 |
|  | 10 | 2 |

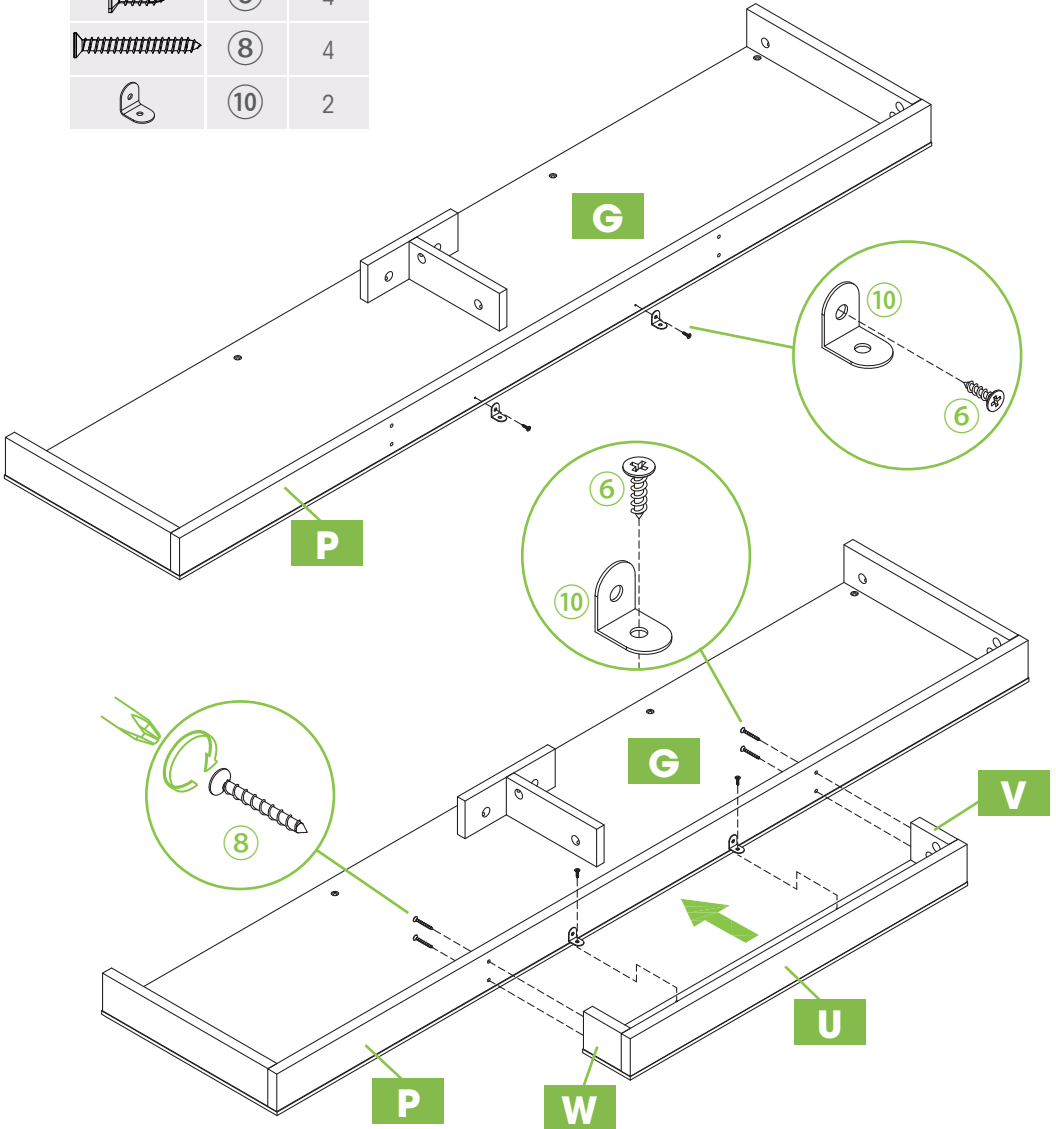

PRODUCT ASSEMBLY

13

| PART | NO. | QTY. |
|---|-----|------|
|  | ④ | 8 |
|  | ⑮ | 1 |

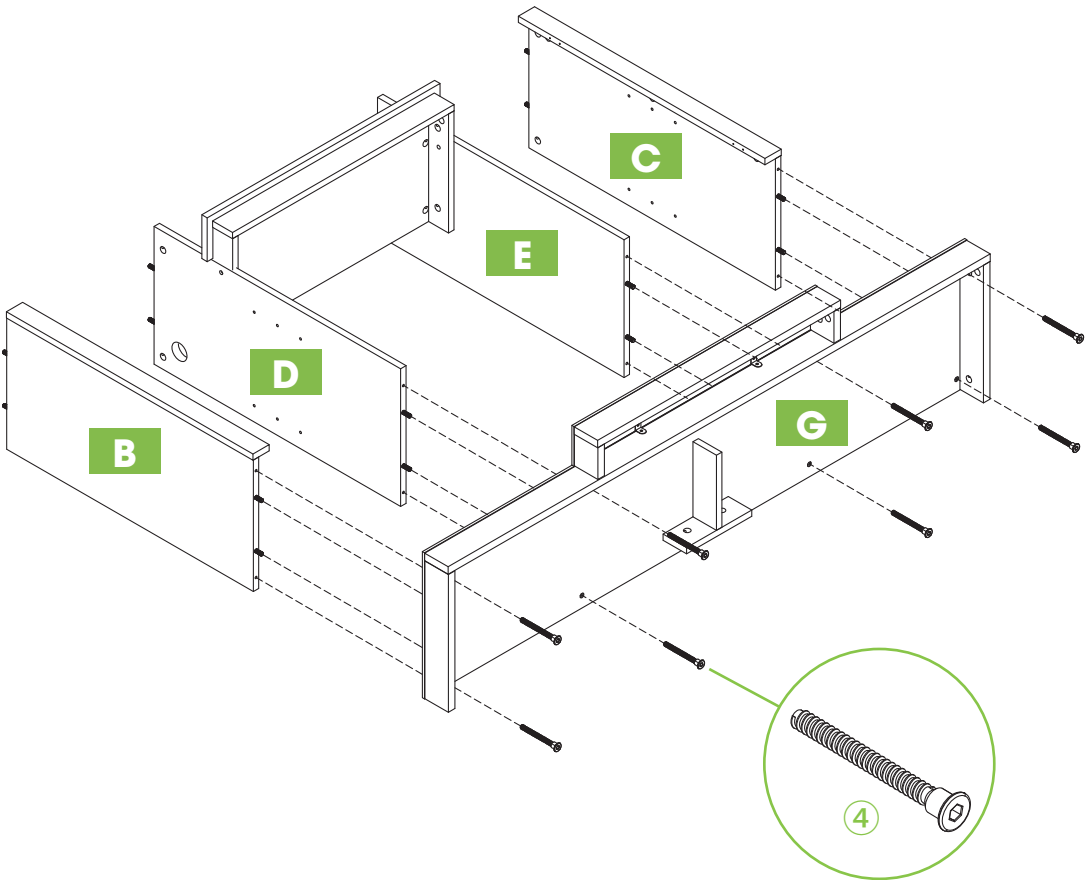

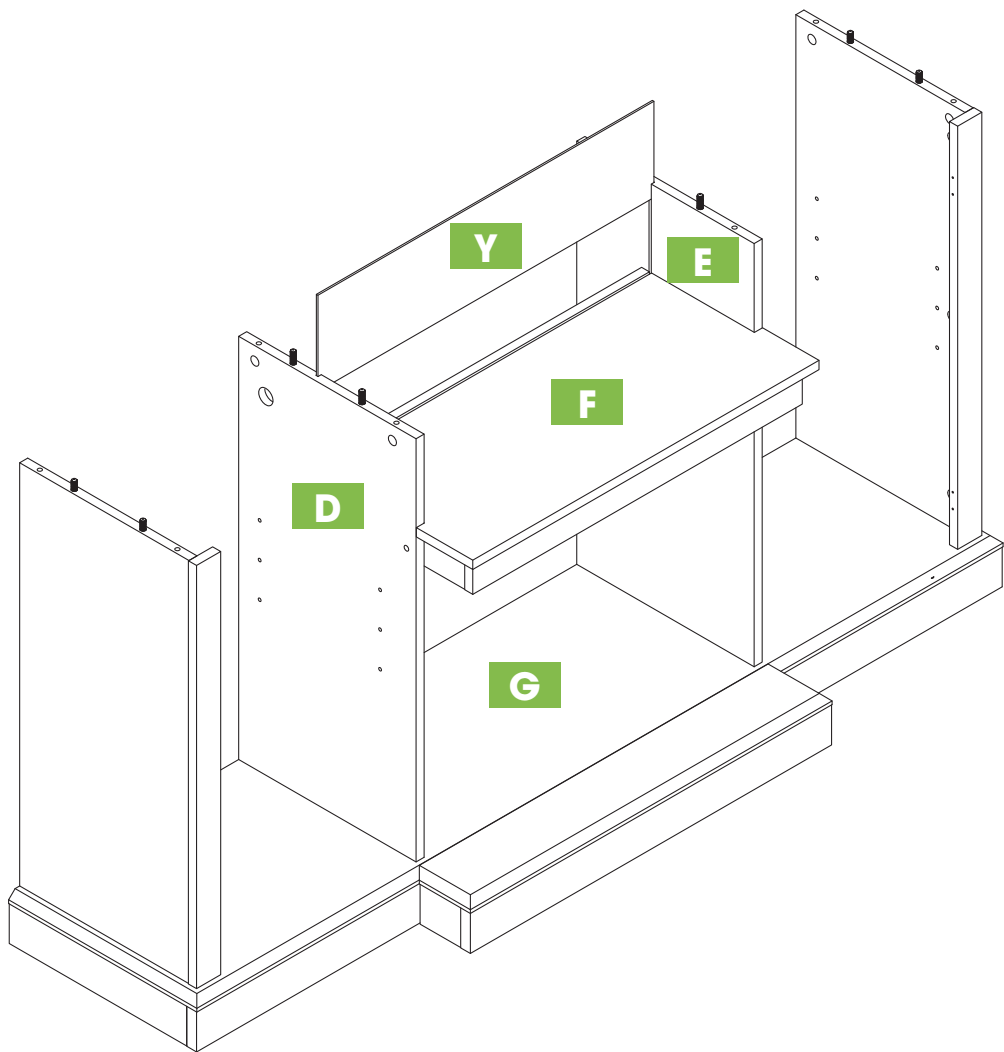

PRODUCT ASSEMBLY

14



PRODUCT ASSEMBLY

15

| PART | NO. | QTY. |
|---|-----|------|
|  | ② | 8 |
|  | ⑥ | 4 |
|  | ⑫ | 2 |

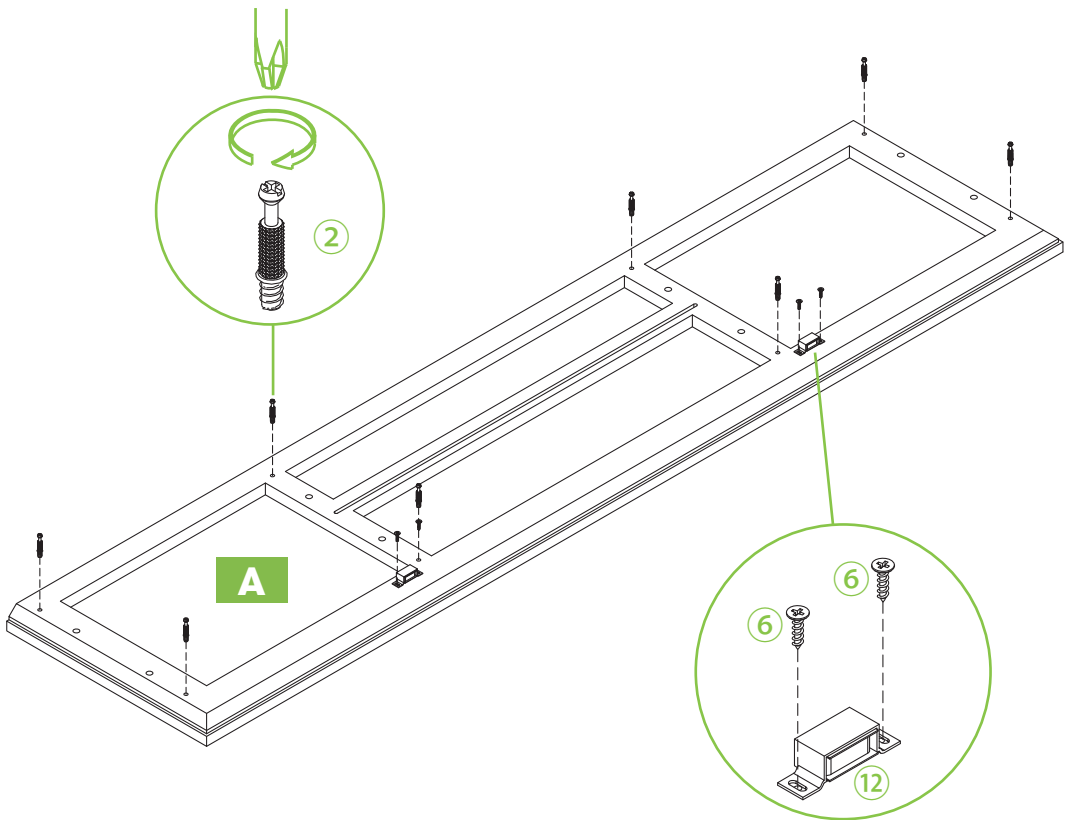

PRODUCT ASSEMBLY



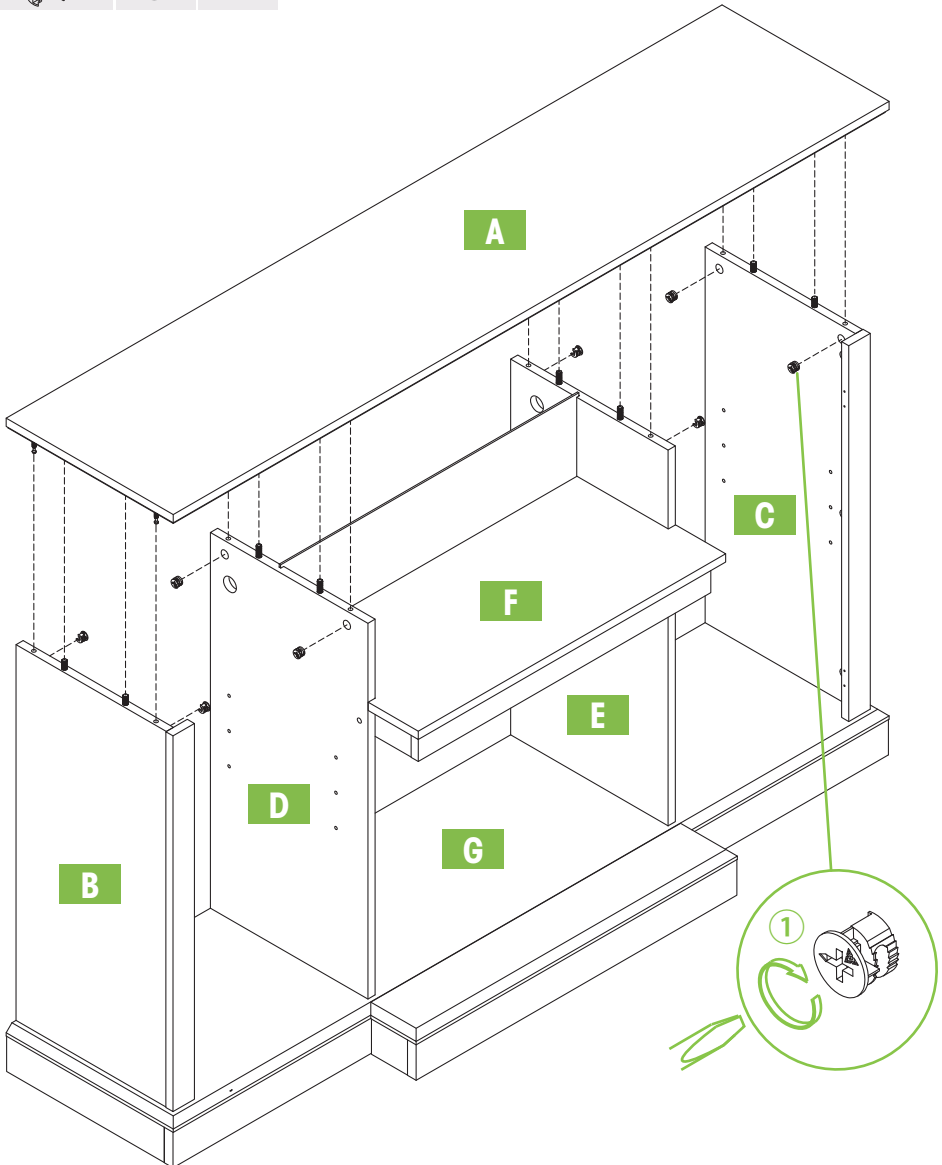

16

| PART | NO. | QTY. |
|---|-----|------|
|  | ① | 8 |



PRODUCT ASSEMBLY

18

| PART | NO. | QTY. |
|---|-----|------|
|  | ⑥ | 14 |
|  | ⑨ | 4 |
|  | ⑪ | 2 |
|  | ⑬ | 2 |
|  | ⑭ | 4 |

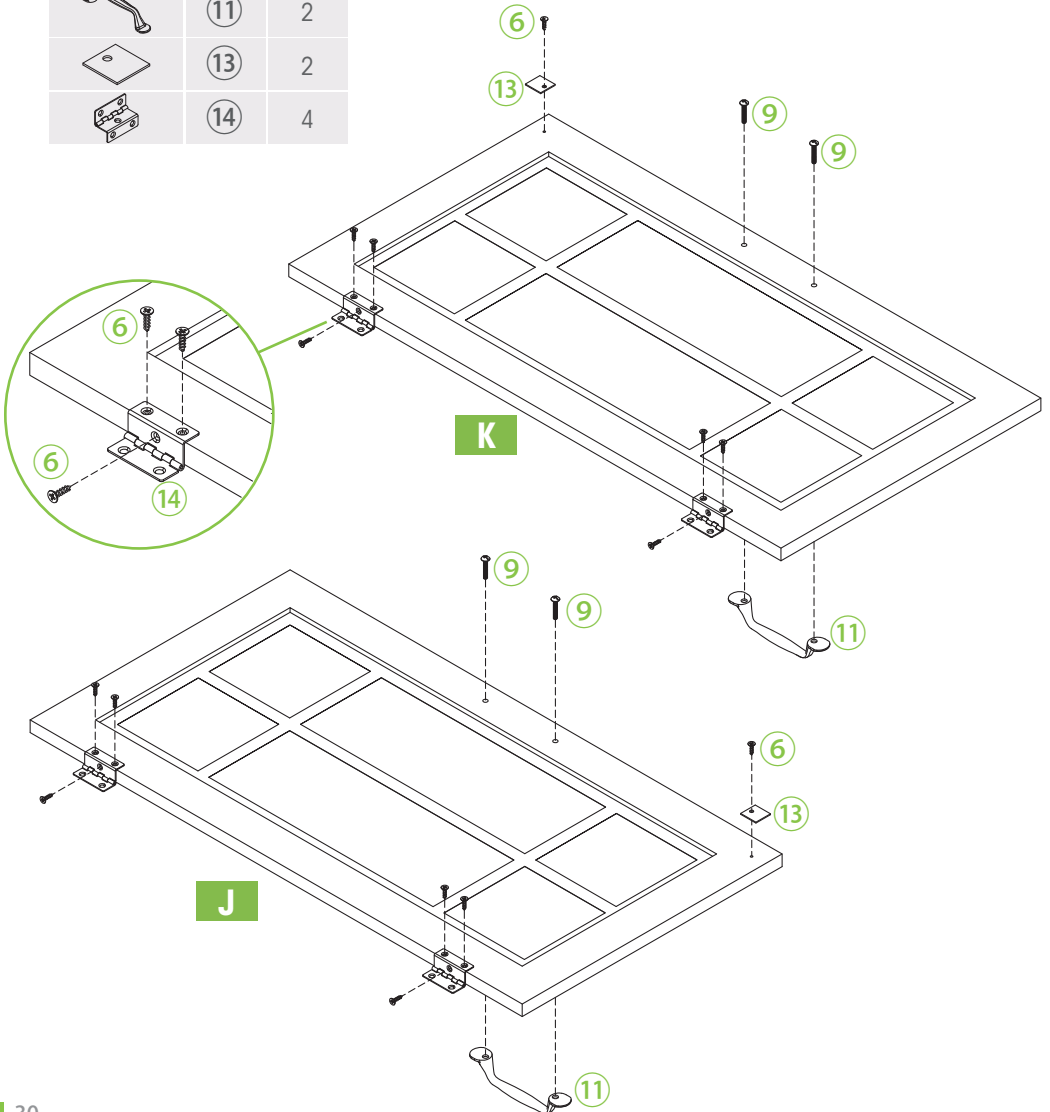

PRODUCT ASSEMBLY

19

| PART | NO. | QTY. |
|---|-----|------|
|  | ⑥ | 8 |

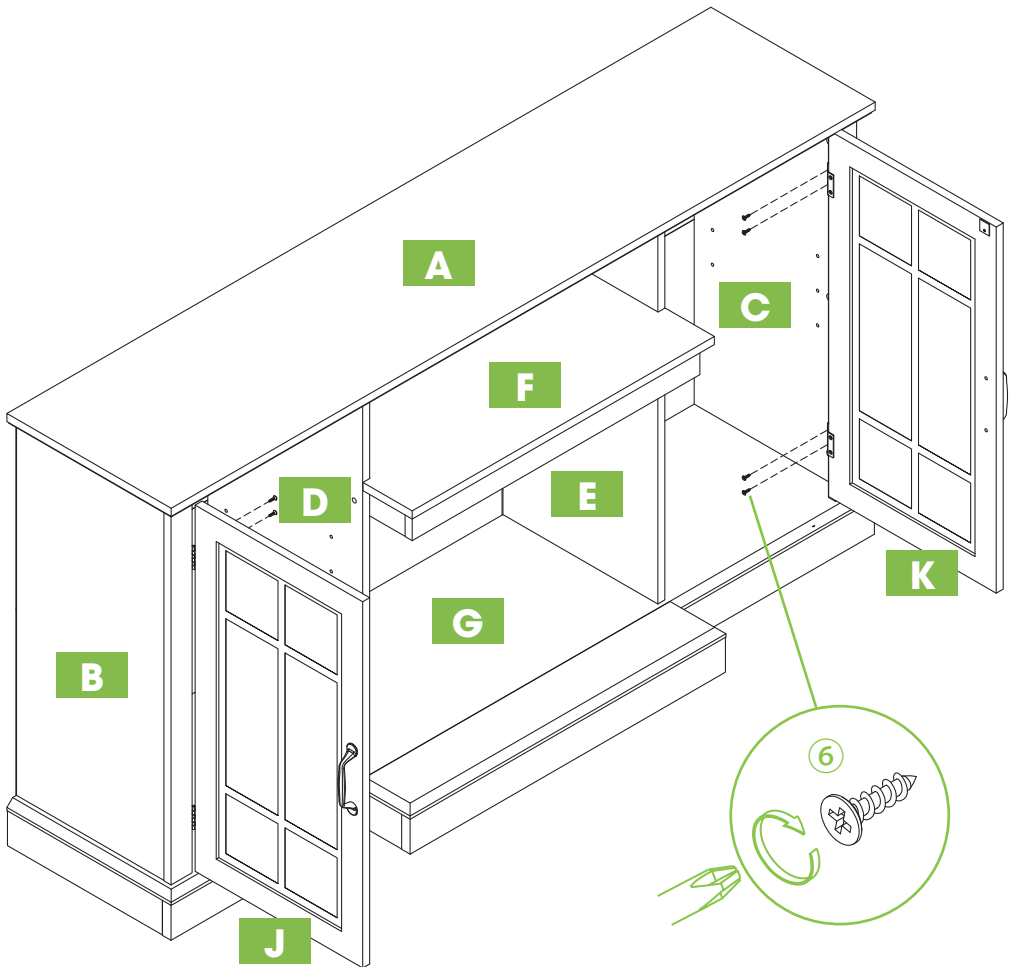

PRODUCT ASSEMBLY

20

| PART | NO. | QTY. |
|---|-----|------|
|  | 16 | 8 |

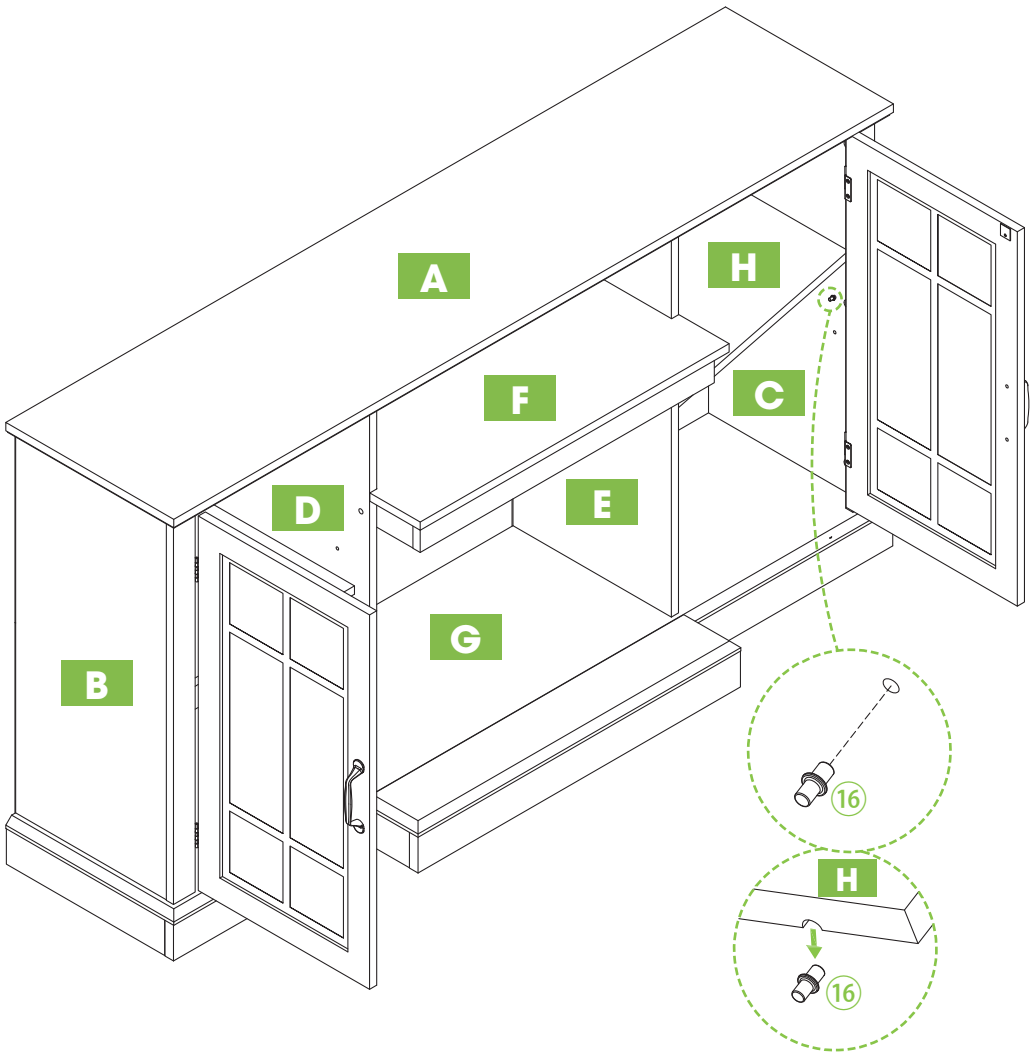

HELP CENTER

Question about your product? We're here to help. Visit us at:

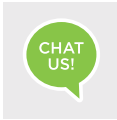

Chat Support



Product Inquiry

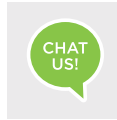

Orders FAQ



Product Assembly



Returns & Refunds

We Stand Behind the Quality of Their Furniture

If you have any issues with your item please let us know! We will always do our best to come up with a solution that you will be happy with.

Please get in touch with our customer service team before returning the product.

And pls do not throw the original box(es) if you have not finished assembling or confirmed no quality issues.

Length of return period:

Items can be returned within 30 days of purchase.

In the meanwhile, everything you purchased from us comes with a one-year warranty.

Who is responsible for the return shipping fee:

We will cover the return shipping fees if:

1. Your item has a manufacturing defect in its materials or workmanship. For example, torn wicker or misaligned screw holes. We will send you a prepaid shipping label after photos are sent.
2. Your item has been damaged in transit. For example, glass is broken or wicker is damaged. We will send you a prepaid shipping label after photos are sent.
3. You receive the wrong box(es) due to a warehouse error. We will send you a prepaid shipping label after photos are sent of the wrong SKU numbers on the outer box(es).
4. One or more boxes are lost in transit. We will send you a prepaid shipping label if you no longer want the item.

*However, we still hope to work with you for a better solution instead of a return. Please don't hesitate to contact our customer service team.

Customer will cover the return shipping fees if:

1. You don't like the product(s) after receiving the box(es).
2. You no longer need the product(s) but you have received the box(es).
3. You buy the product(s) by mistake but you have received the box(es).
4. Order/Shipment cancellation failed and you have received the box(es).

Return Request

In order to get a full refund as described in this return policy, all items must be: (1) In a brand new/unused condition, please provide photos before and after packaging. (2) When returning, all accessories and parts are firmly packed in all original packaging. If your return does not meet the requirements, you may not get a full refund.

When will I be refunded?

The refund is released once the goods have been returned to our warehouse.

What if the product is damaged/defective outside of the valid return period?

We want you to be a happy customer. Please reach out to us by email and we will come up with a solution to make sure you are satisfied.