

COMPUTER DESK INSTALLATION INSTRUCTION

△ NOTICE!

- Thank you very much for choosing our products. Please read the installation instructions carefully before installing.
- When installing, please do not tighten the screws at the beginning, this will lead to the hole of other parts not to be adjusted well. All the screws should not to be tightened after all the parts are finished.
- If the wood skin covers the screw hole, please use a screwdriver to poke carefully and slowly, it can avoid harming the wood skin.

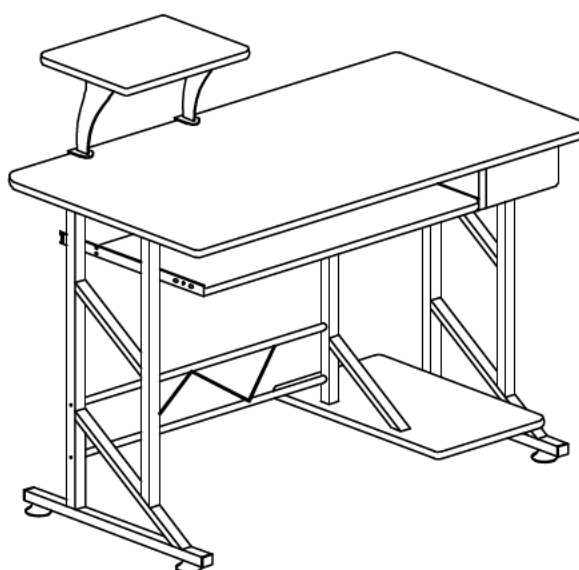

NEED TWO PEOPLE INSTALL









Maintenance Instructions

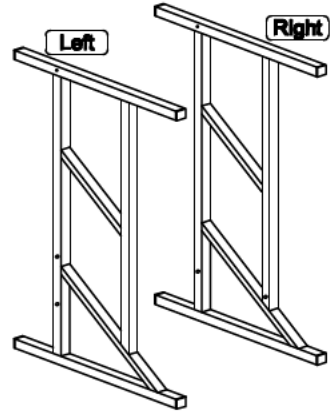

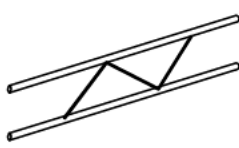
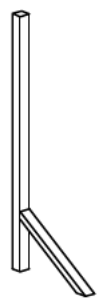
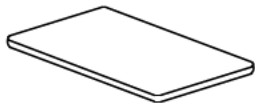
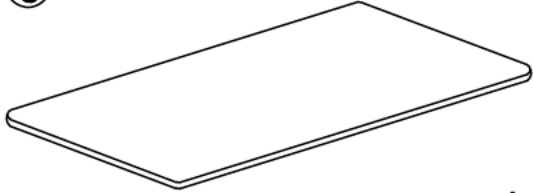

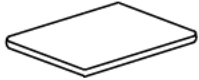
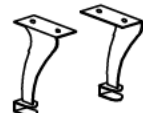

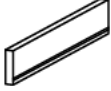

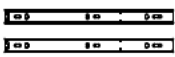
After a period of time, hardware accessories may be loose, please use the installation tool to tighten again.

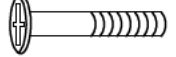
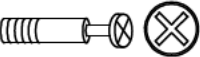
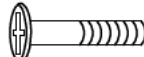
The ground must be smooth and flat.

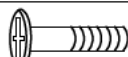
Usually to wipe the furniture with a piece of wet cloth that wring out, and then wipe with the dry cloth.

Furniture is best to avoid the direct sunshine.

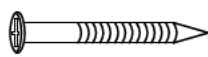
<p>①</p>  <p>x2</p>	<p>②</p>  <p>x1</p> <p>③</p>  <p>x1</p>	<p>④</p>  <p>x1</p>
<p>⑤</p>  <p>x1</p>	<p>⑥</p>  <p>x1</p>	<p>⑦</p>  <p>x1</p>
<p>⑧</p>  <p>x1</p>	<p>⑨</p>  <p>x1</p>	<p>⑩</p>  <p>x1set</p>
<p>⑪</p>  <p>x1</p>	<p>⑫</p>  <p>x2</p>	<p>⑬</p>  <p>x1</p>
<p>⑭</p>  <p>2.5MDF x1</p>	<p>⑮</p>  <p>x2 set</p>	

PART	QTY	SPEC		PART	QTY	SPEC	
A	3	6x40 MM		G	4	6x35 MM	
B	8	6x35 MM		H	8	4x14 MM	
C	2	6x30 MM		I	4	4x8 MM	
D	4	6x10 MM		J	2		
E	2	5x60 MM		K	4		
F	2	5x50 MM	