

ASSEMBLY INSTRUCTION

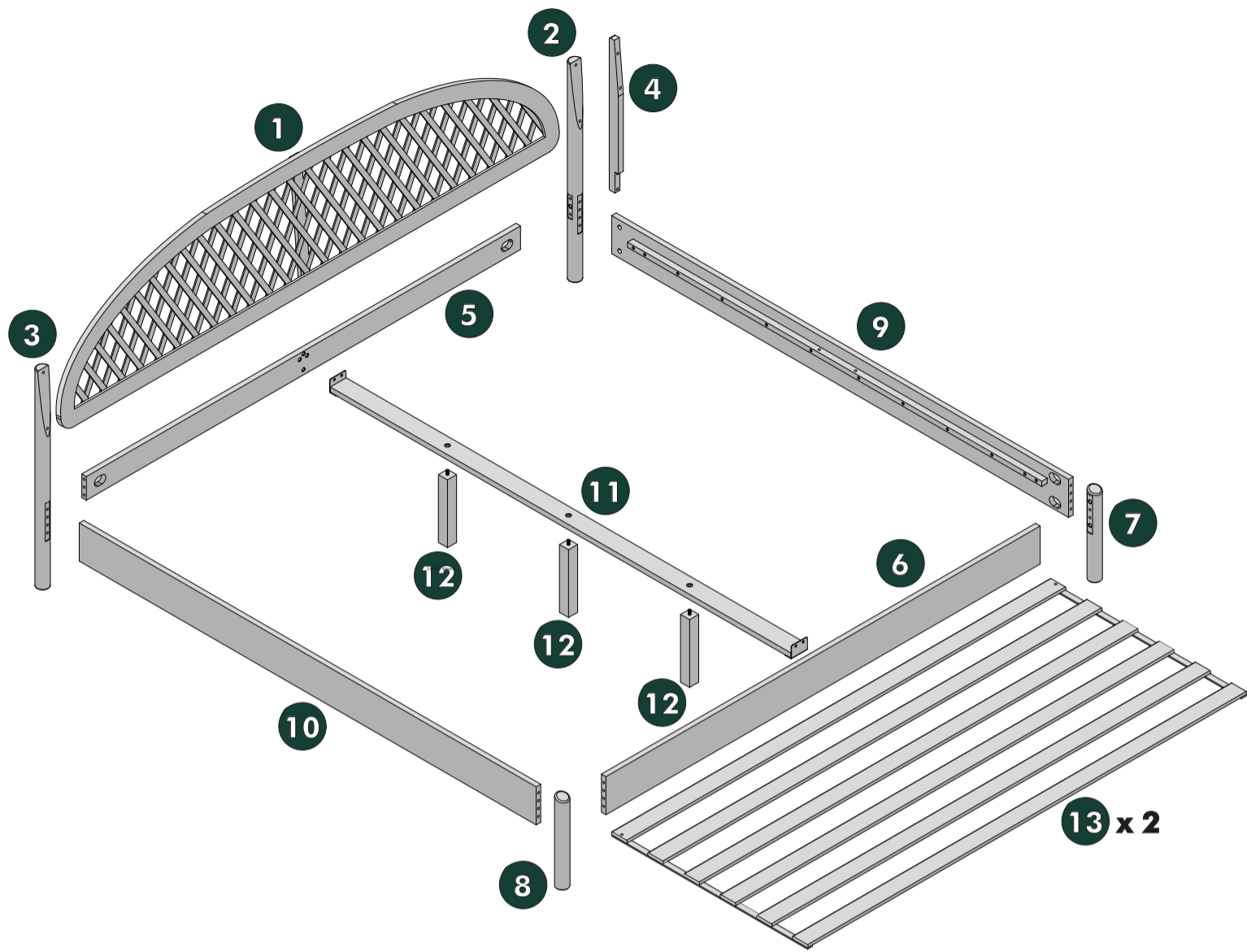

**TEAM ASSEMBLY
RECOMMENDED**

GEM KING/QUEEN BED

Components

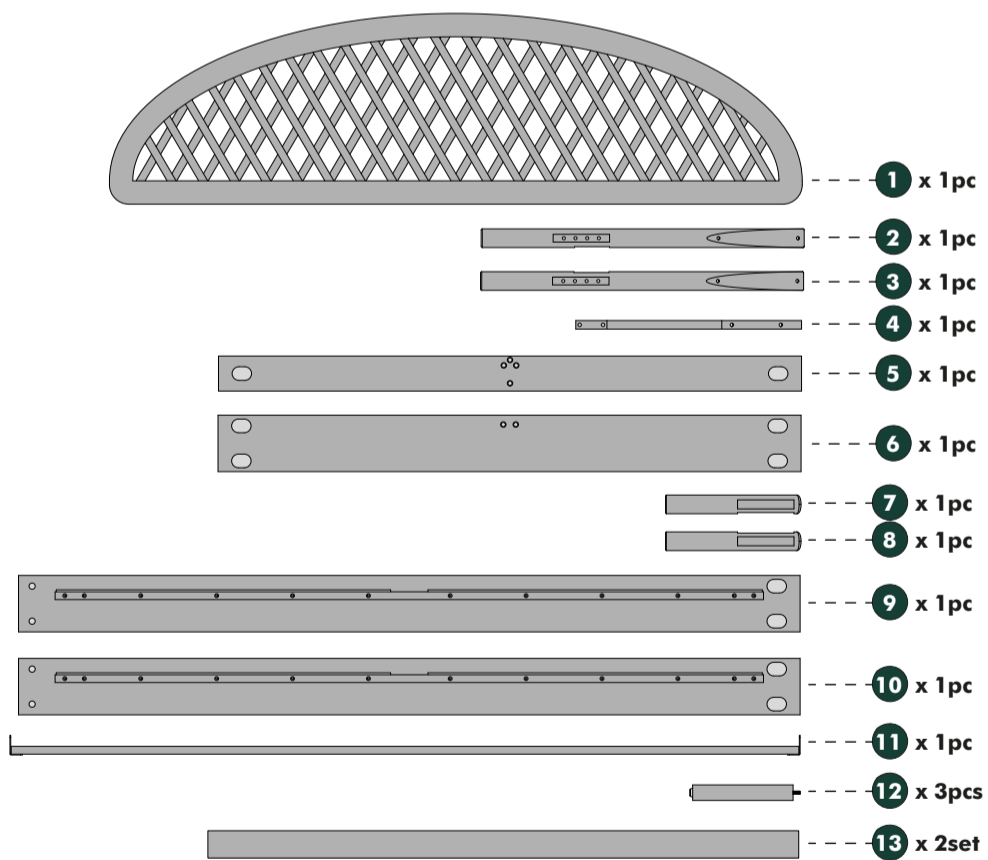

A		M6*90 Bolt	4
B		M8*15 Bolt	4
C		M8*35 Bolt	4
D		M8*40 Bolt	4
E		M8*50 Bolt	10

F		Flat Washer	6
G		Cross Dowel	4
H		Arc Washer	10
I		M5 Allen Key	1

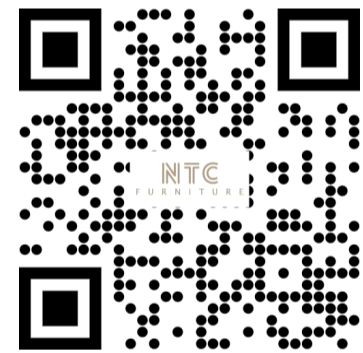

<https://sqr.co/ntc-gem>

Return Policy

Thank you for choosing NTC. We are committed to providing high-quality products that are designed to withstand heavy daily use by the most demanding users. When you purchase NTC products, you can be assured that you are receiving authentic products that meet our rigorous standards.

NTC is not responsible for normal wear and tear, products used commercially, or failures caused by accidents, abuse, alteration, modification, misuse, or improper care.

We provide the following warranties:

30-day satisfaction warranty across our product line. Specific warranties for each item. Please refer to your User Manual for the exact coverage.

If you encounter any technical issues while installing or configuring our products, please contact our qualified staff for professional assistance. Replacement parts or products will be sent at our discretion if the defect is the result of any fault on our side. You must provide proof of purchase, with the date of purchase, as well as photos of the defective merchandise. Photos may be used to determine the cause of defects and for future quality control. If you wish to return a purchased product, please refer to our Return Policy.

For any questions, comments, or concerns, please contact NTC store or reach out to us via email at customerservice@ntcfurniture.com

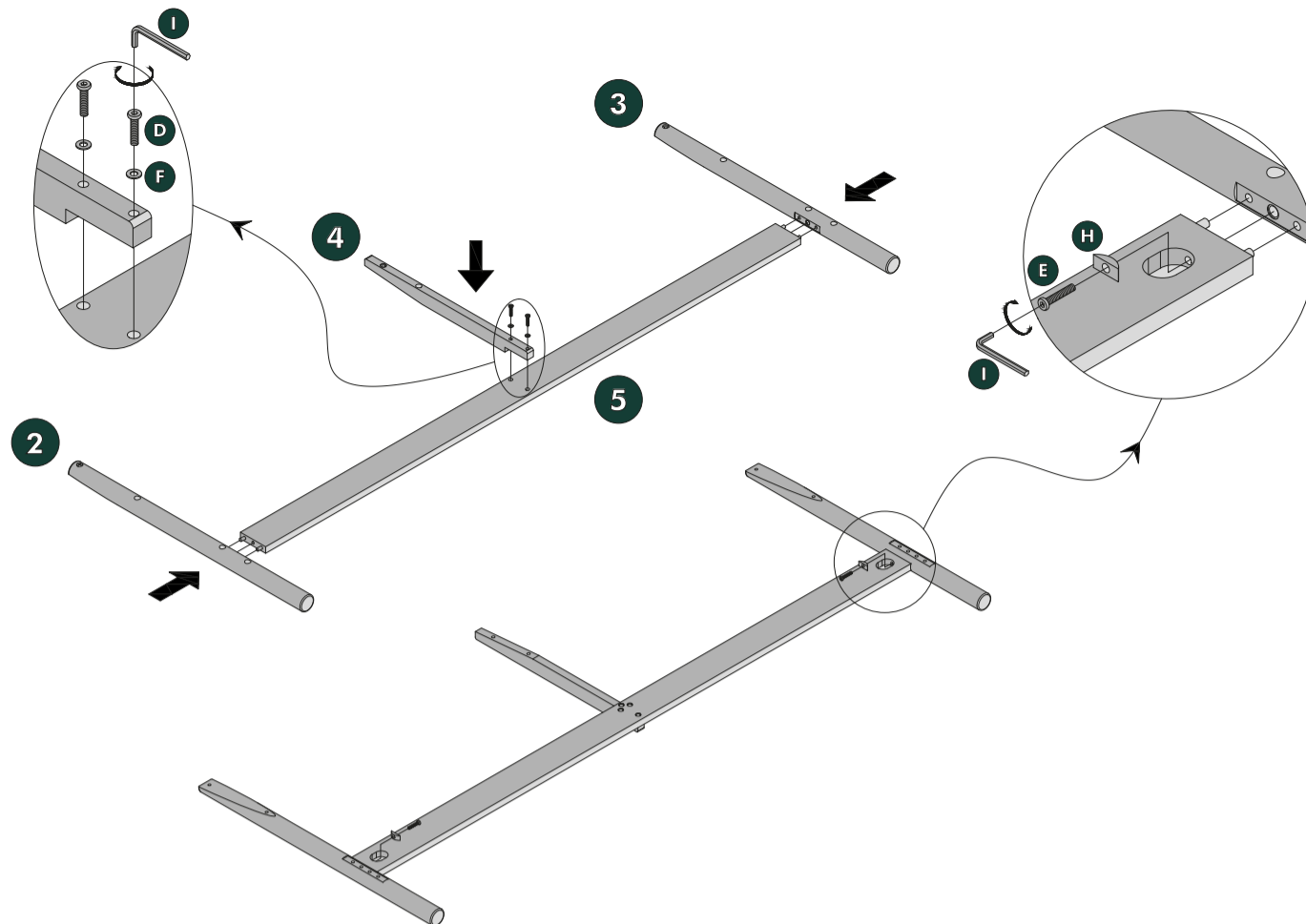
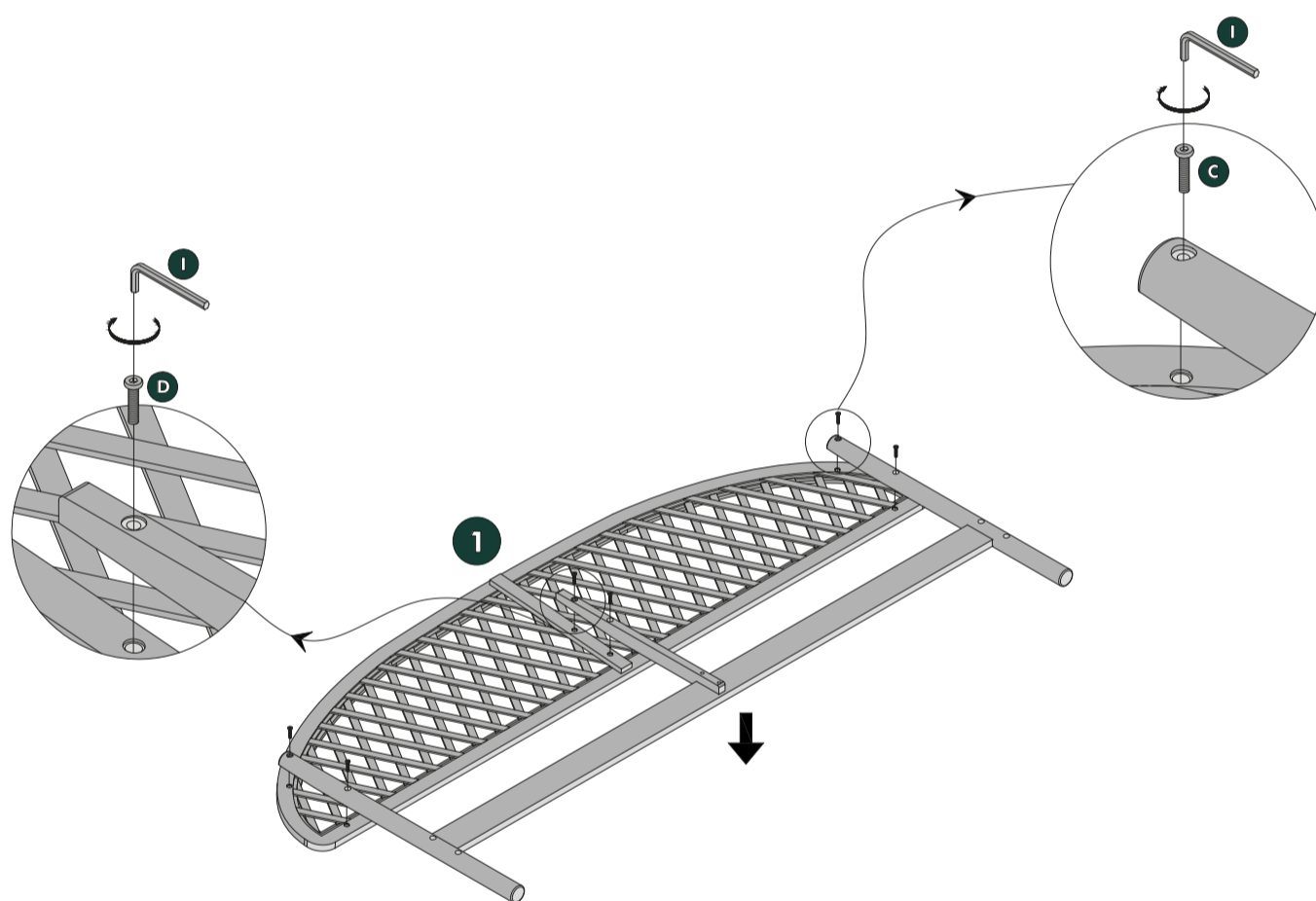
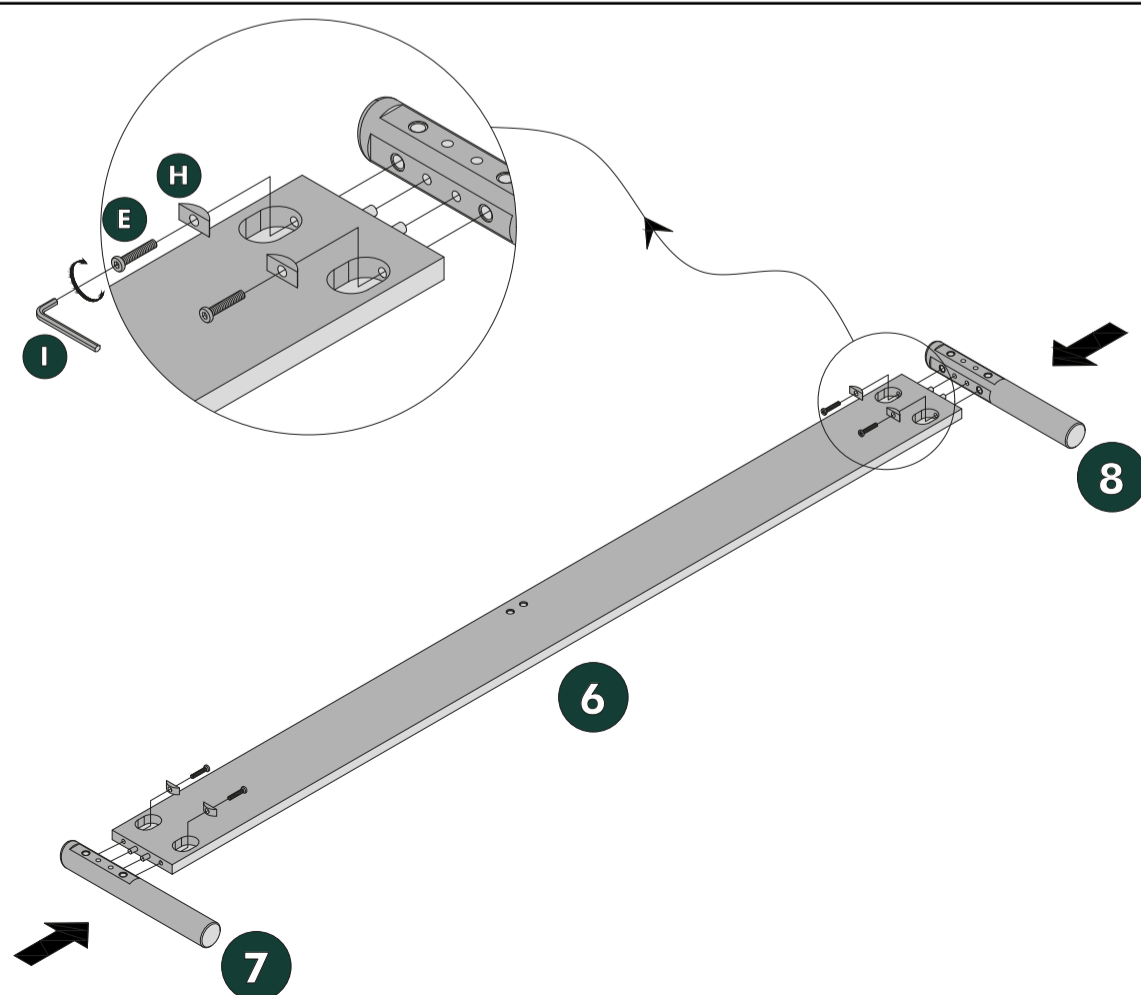
1**2****3**

4

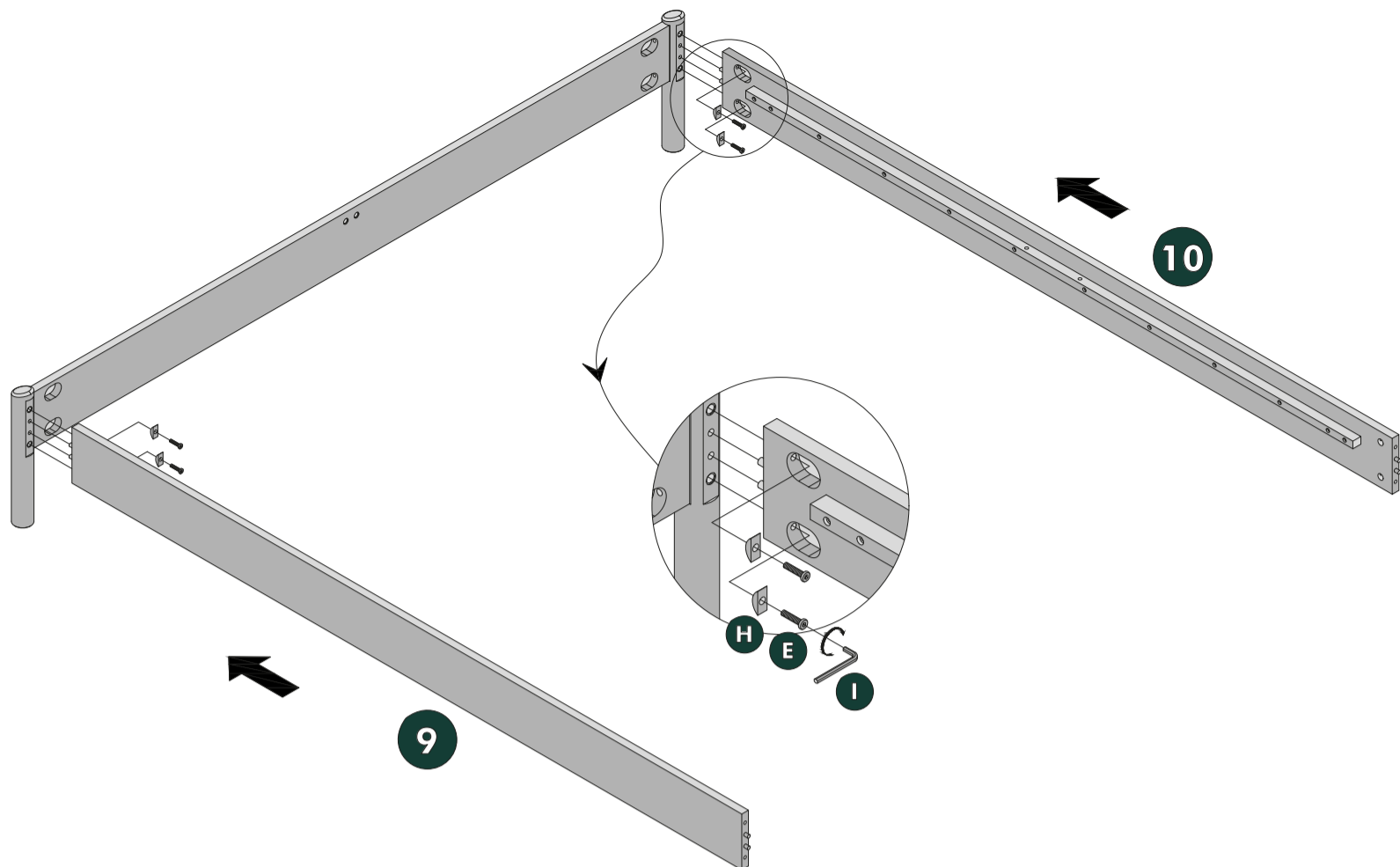

5

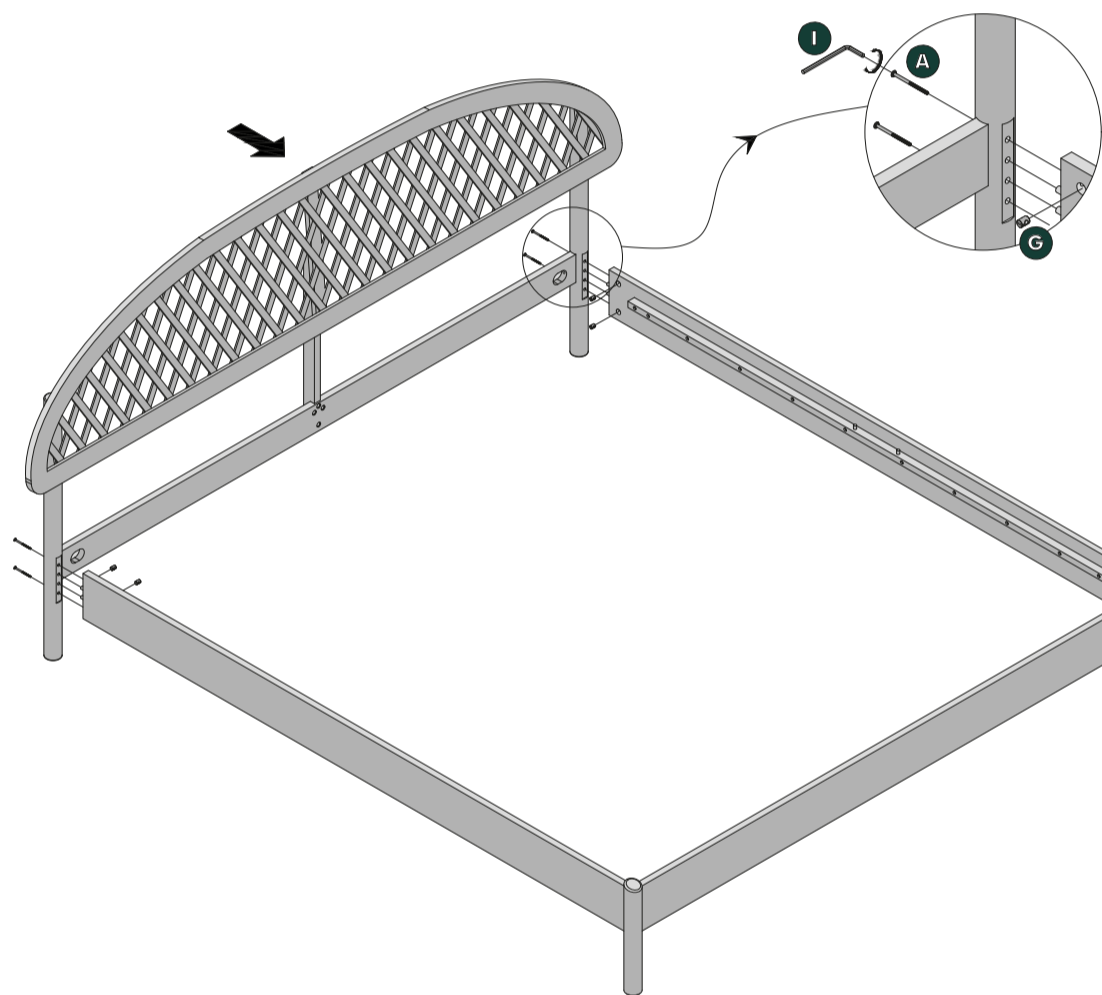

6

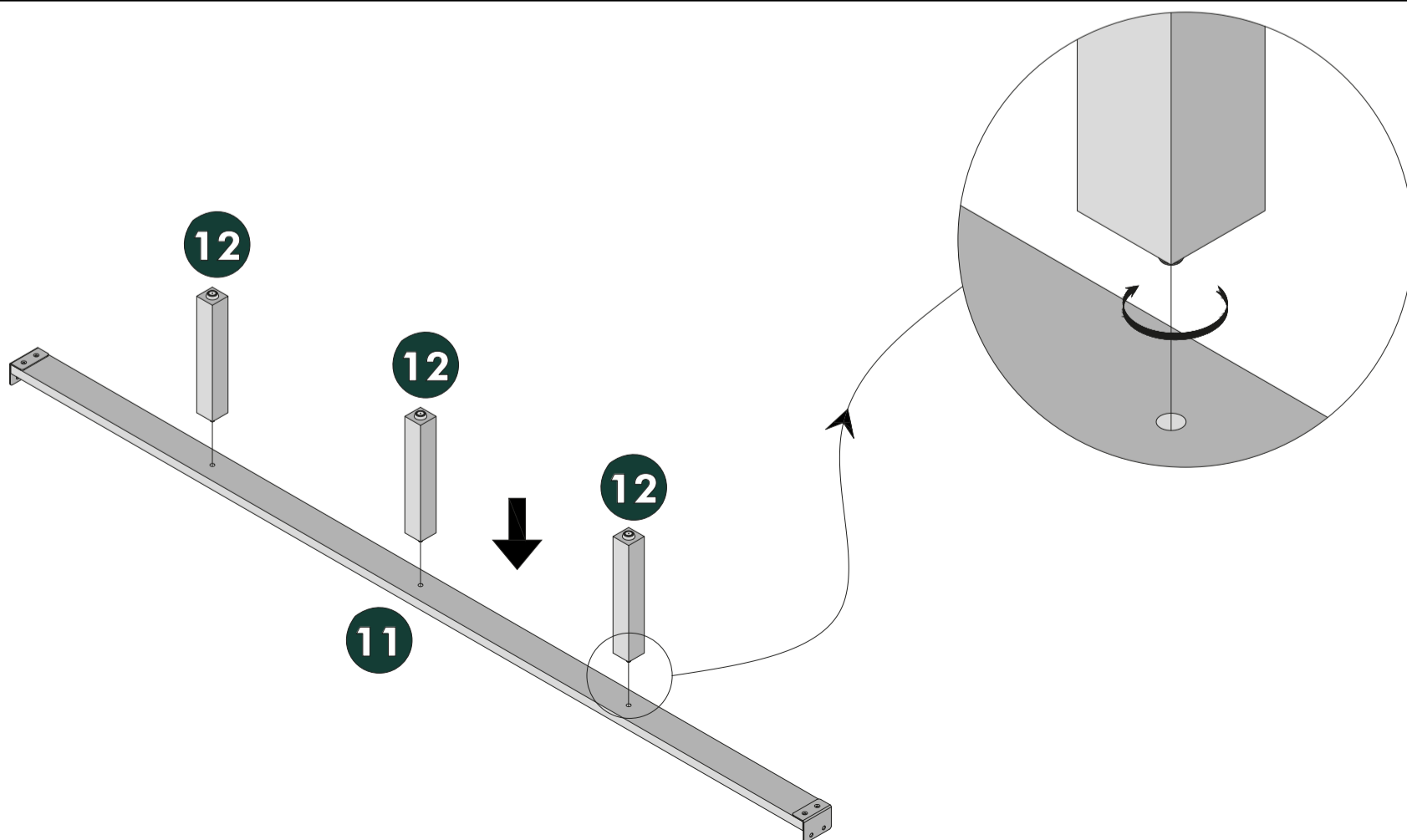

7

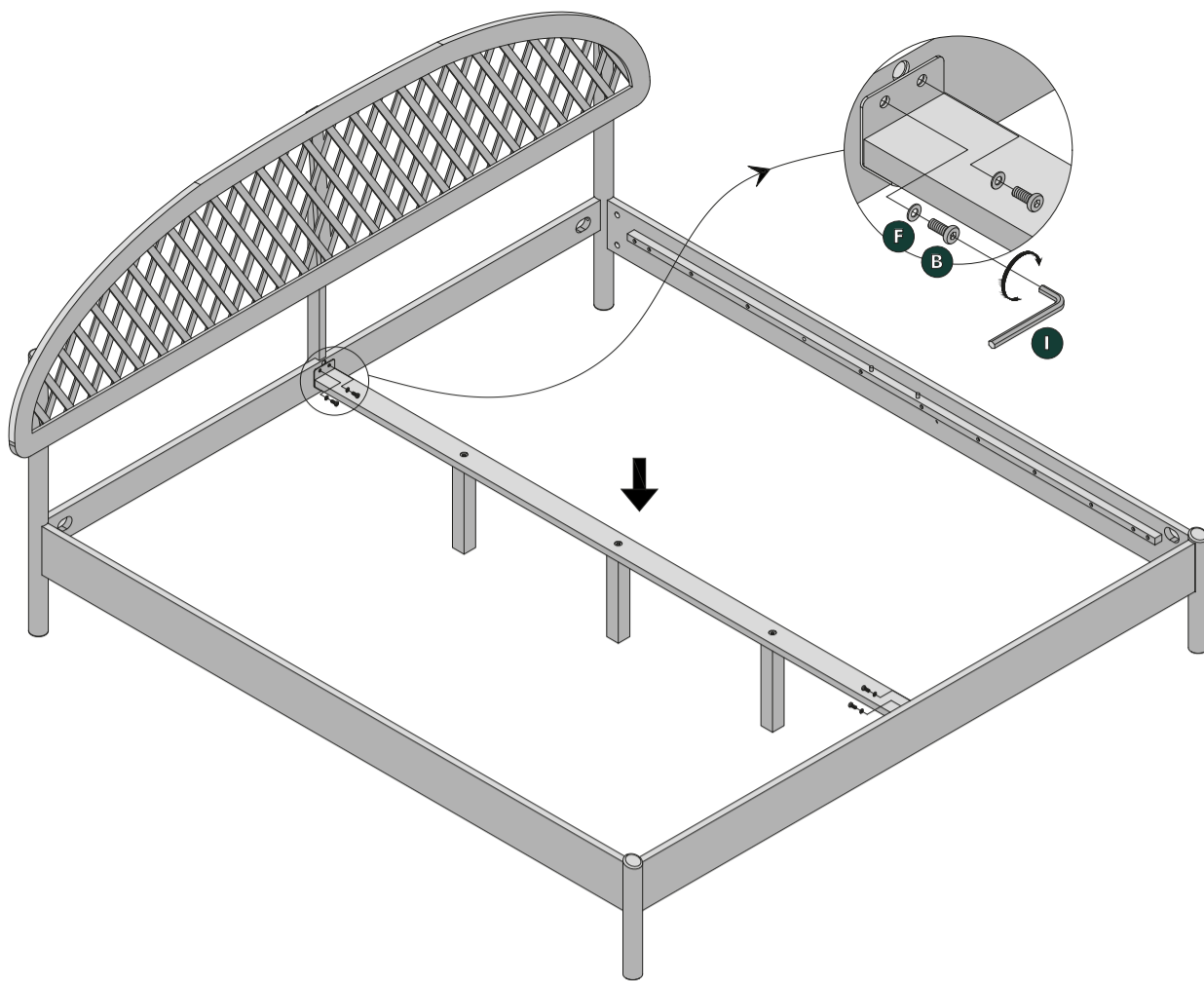

8

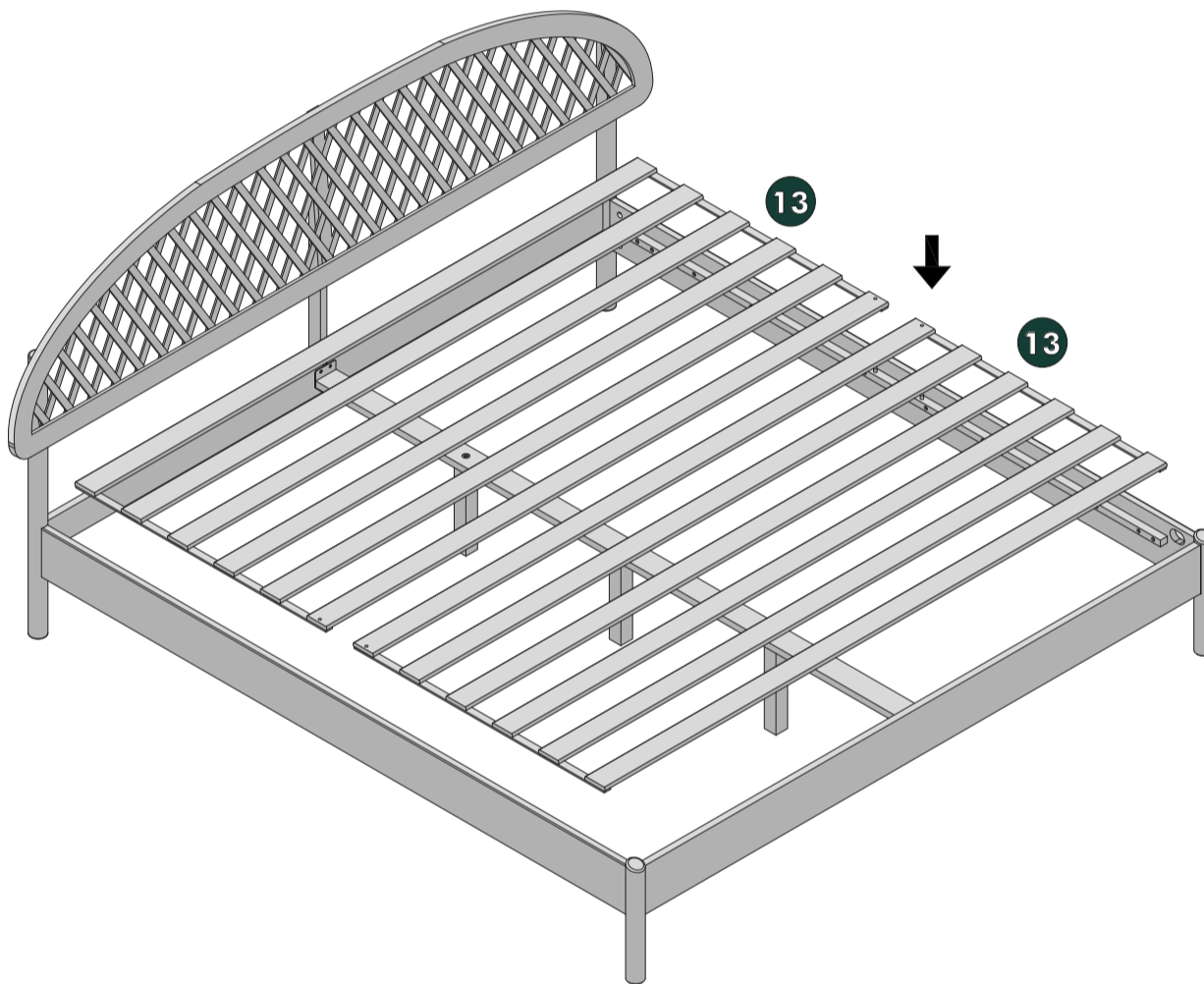

9

