













5-SHELF STORAGE RACK

User Guide

5-Shelf Storage Rack

Contents:

Before getting started, ensure the package contains the following components:

| Part | | Qty | |
|------|------------------|---|----|
| A | Beam |  | 10 |
| B | Brace |  | 10 |
| C | Post |  | 8 |
| D | Press board |  | 5 |
| E | Protective cover |  | 8 |
| G | Connector |  | 4 |
| H | Rubber mallet |  | 1 |
| I | Glove |  | 1 |
| J | Long fence |  | 5 |
| K | Short fence |  | 10 |
| L | Wheel |  | 4 |

Assembly

Step 1 :

Insert the protective covers

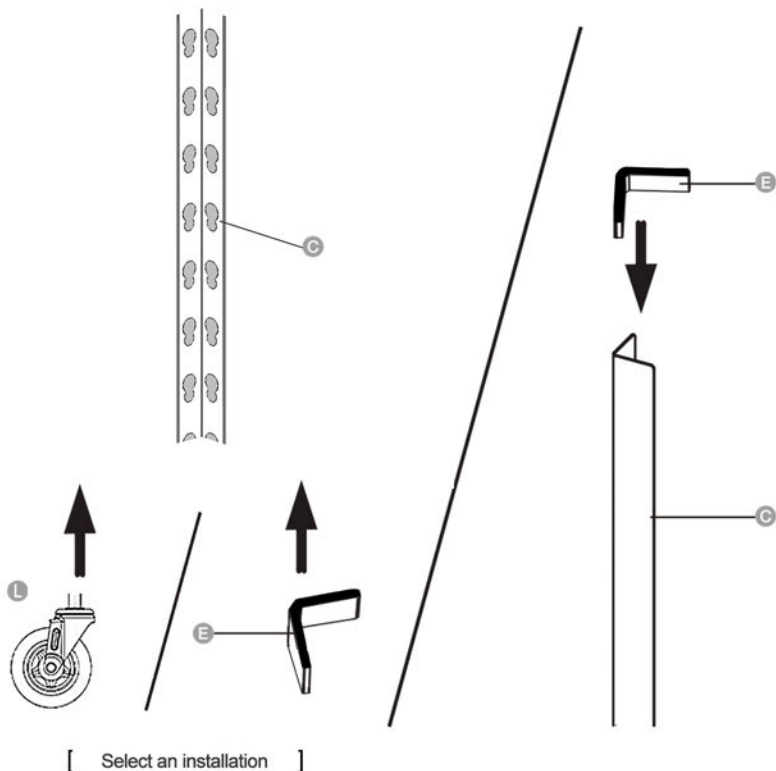

- Insert all 4 protective covers **E** to the bottom of the post **C**, or install **L** four wheels at the bottom of the column.
insert another 4 protective covers **E** to the top of the remaining 4 pieces post **C**.
- **Note:** Do not omit this step, which could protect your floor from scratches.

Assembly

Step 2 : Setting Up the Brace

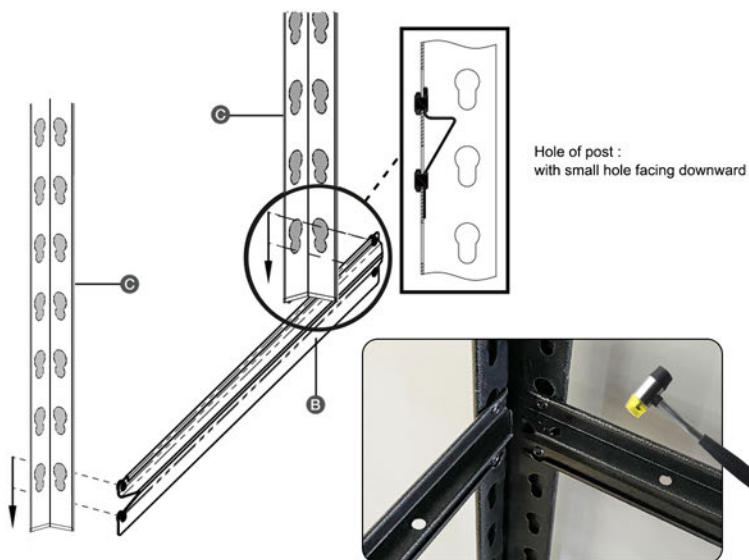

- Slide the rivets of brace **B** into posts **C** of your desired location with the key slot pointing down and shelf ledge of brace **B** facing up. Tap lightly to seat rivets.
- **Note:** Make sure all the rivets are fully seated into the post slots. You may want to use a rubber mallet (not included) to help push the rivets into the post slots. This applies to all the rivets used in this unit.

Install as follows :

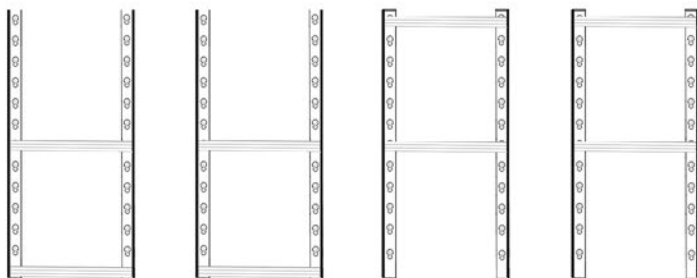

Assembly

Step 3 :

Setting Up the Beams and the Braces

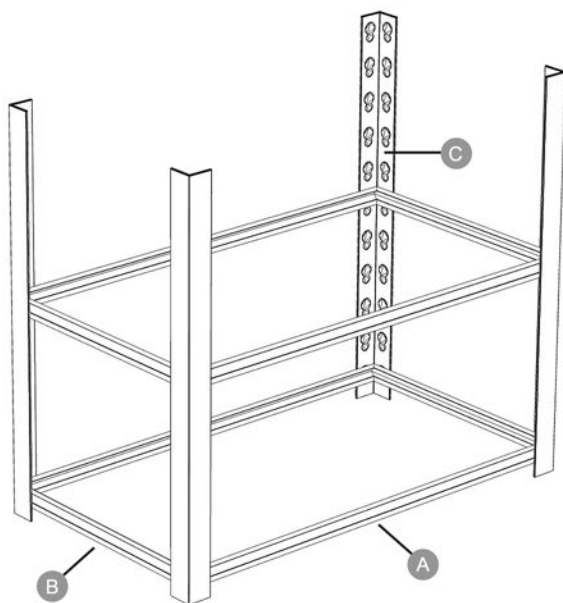

- Repeat the previous step 2 to attach beams **A** and braces **B** to posts **C** until the first and the second levels are assembled .
- **Note:** Each of the beams **A** and braces **B** on the same level should be at the same height.

Assembly

Step 4 :

Setting Up the Upper Post

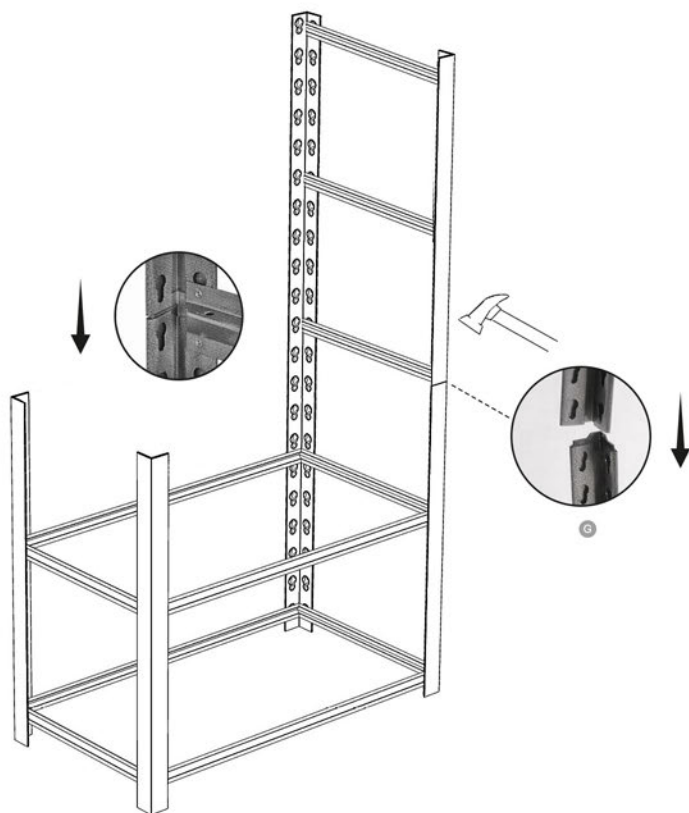

- Put the connector ⑥ into the top of the bottom post to install the upper post
- The middle beam is stuck in the hole at the connection of the upper and bottom post , help strengthen the links of the upper and lower shelves

Assembly

Step 5 :

Setting up the Middle Beams and Braces

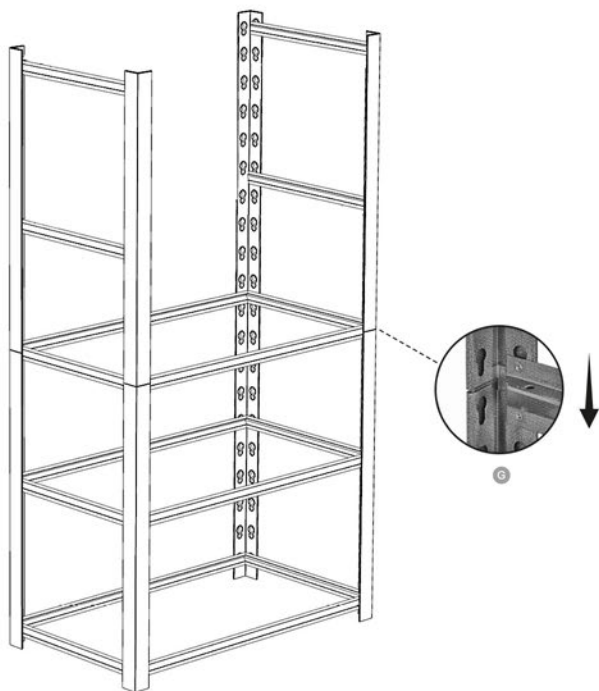

- Please note that the middle layer needs to be connected with upper and bottom post to increase firmness, so it can not be adjusted up and down

Assembly

Step 6 :

Setting Up the remaining Beams and Braces

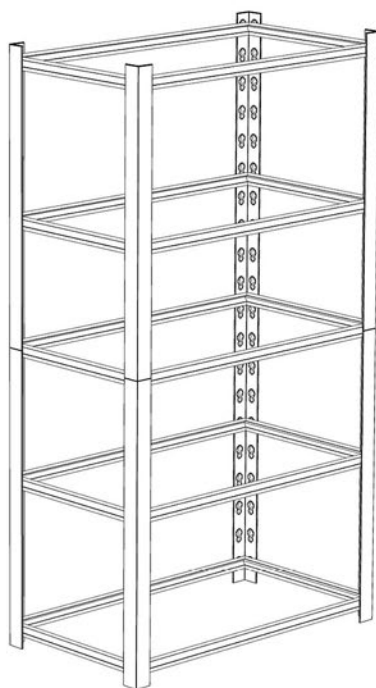

- Repeat step 2 and step 3 to assemble the remaining beams and braces

Assembly

Step 7 :

Setting Up the press boards

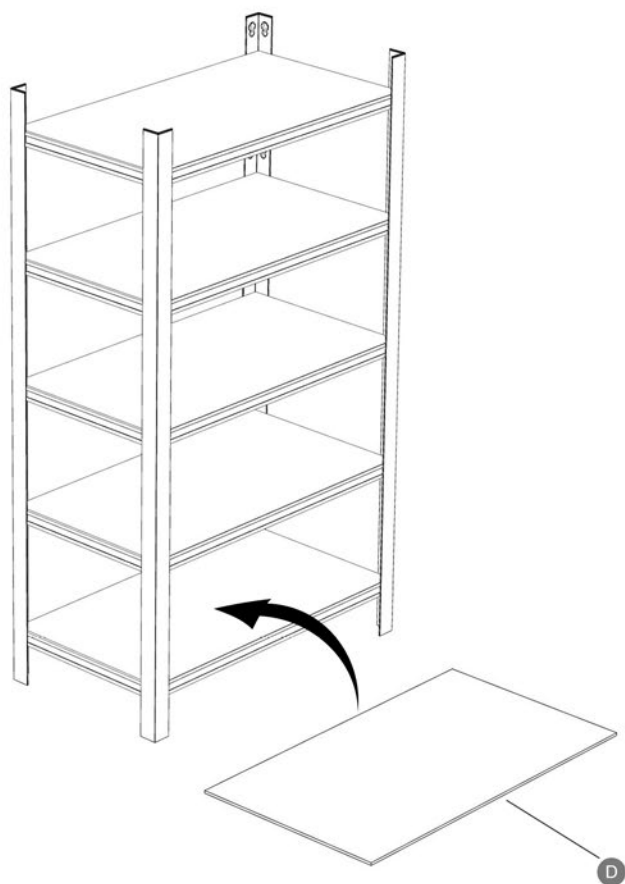

- Hold the press board at an angle to make it easier to fit them onto each previously assembled level on the frame.

Assembly

Step 8 :

Install long fence and short fence

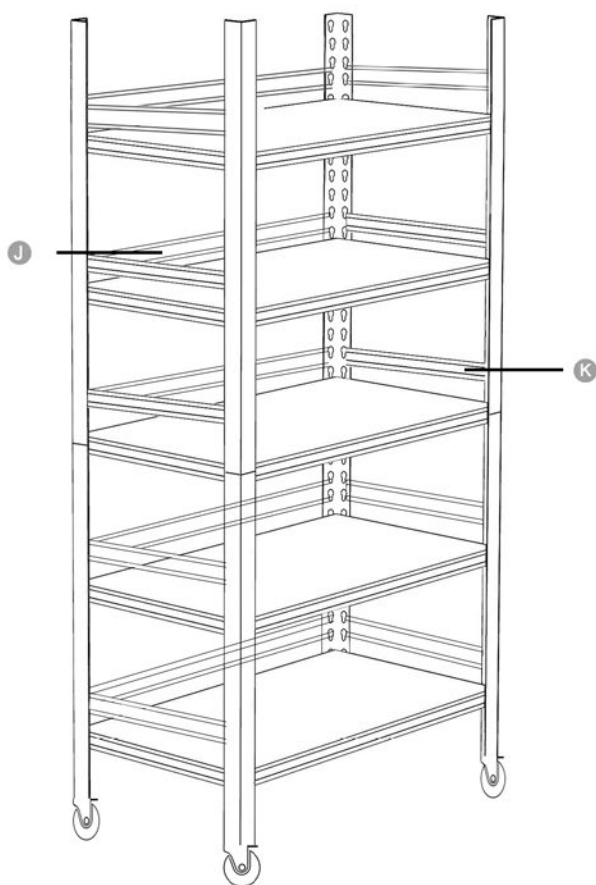

Safety and Compliance

Please read and understand this entire manual before using the product.

CAUTION

- Be aware of dynamic loading! When it is suddenly overloaded, it may lead to product failure.
- Evenly distribute the weight on each shelf, and keep the heaviest loads on the bottom shelf.
- Use only on flat, level and hard surface capable of supporting the shelving and any items placed on it. Remember to only use the shelf on level ground with evenly distributed weight.
- Do not store flammable liquids in the unit unless they are secured in an approved container.
- Keep bystanders out of the area during assembly.
- This product is not a toy. Please do not allow children to play on or near the equipment.

WARNING

- Do not stand on, step on, or alter this unit for anything outside the designed function of storage.
 - Use carefully when handling and assembling metal parts.
 - The metal may have sharp edges or corners. We recommend the use of protective gloves.
 - Always remember to use proper lifting techniques when moving the boxed or assembled unit.
-

Preparation

Before you start installing the product, make sure all parts are present. Compare parts with package contents list. If any part is missing or damaged, do not attempt to assemble the product. It is recommended that this product be assembled on a clean, soft surface, such as a piece of cardboard. The assembling task can be performed by one person but availability of a second person will make the task simpler.

Troubleshooting

| PROBLEM | POSSIBLE CAUSE | CORRECTIVE ACTION |
|---------------------|---|---|
| Shelf is not level. | <ul style="list-style-type: none">• Beam(s) or brace(s) used for the same level are not at the same height or they are assembled upside down.• Rivets on the beam(s) or brace(s) are not fully seated into the post slots.• The ground is uneven or too soft. | <ul style="list-style-type: none">• Re-assemble beam(s) or brace(s).• Fully seat the rivets.• Move the shelf to a flat, level and hard surface. |