



Outdoor
Living Today

ASSEMBLY MANUAL

4x2 Garden Chalet

with Cedar Roof

Stock Code:
GC42-BEV-CEDAR

Version #1.5
Sep 23, 2025



CONTACT

ADDRESS

9393 287th Street,
Maple Ridge, British Columbia,
Canada V2W 1L1

PHONE & FAX

Toll Free: 1-888-658-1658

Fax:

ONLINE

Email: olmsupport@outdoorlivingtoday.com

Web: www.outdoorlivingtoday.com

Important Information

1. Proper Installation and Use

Our products are designed for use based on proper installation on level ground and normal residential use. To ensure optimal performance and longevity, please follow the instruction manual provided during the assembly process. Be sure to retain the manual for future maintenance purposes.

2. Site Preparation Responsibility

Customers are responsible for ensuring a solid, level, and well-draining site for construction. A stable foundation is essential for the structural integrity of the product.

3. Compliance with Local Regulations

Before ordering this product, please check with your local municipal or county authorities to confirm that it complies with building codes and regulations.

4. Snow Load Considerations

- Snow load ratings vary by geographical location. If heavy or wet snowfall occurs, it is advisable to promptly sweep snow off the roof to prevent excessive weight.
- For elevated structures, any structural and building code requirements are solely the customer's responsibility and should be strictly followed.

5. Wind Conditions and Secure Installation

- In areas with high or gusty wind conditions, it is crucial to install the structure securely to the ground.
- Regular maintenance is essential to ensure that screws, doors, windows, and other parts remain tightly affixed.

6. Liability and Customer Support

- Customers agree to hold Outdoor Living Today and any Authorized Dealers free of any liability for improper installation, maintenance, and repair.
- In the event of a missing or broken piece, contact the Outdoor Living Today Customer Support Line at 1-888-658-1658 within 30 days of delivery. Replacement parts will be couriered free of charge within 10 business days.
- All structures purchased from Outdoor Living Today are covered for one year against defects in manufacturing and workmanship. Costs incurred for customer installations are not included.

7. Warranty Considerations

- Failure to use the supplied parts included in this kit could result in poor product performance and may void your warranty.
- If you plan to deviate from our written instructions, please contact Outdoor Living Today's Customer Toll-Free Line for guidance.

What to do Before my Shed Arrives?



Become familiar with this assembly manual and determine if you can complete the project yourself or will require a professional contractor.



One helper is recommended to assist in constructing your chalet. It generally takes two people less than a day to assemble a chalet. If you're hiring a contractor, their rate should be in line with that duration of work.



Clear the construction area and ensure a clear pathway for delivery when the freight company arrives. Remove all debris: roots, grass, rocks, etc.



Excavate the site. Contact your local utilities company to ensure there are no gas or electric lines buried in the area before digging.



Decide on the type of foundation you will be using:
- Concrete slab, or
- 4-6 inches of crushed gravel with paver stones or 4x4 stringers.

You can find the footprint for your shed on Page 3 of your Assembly Manual.



If doing the assembly yourself, have all the necessary tools ready to go and in working condition. A list of required tools can be found after the parts list.

Foundation Types for 4x2 Garden Shed

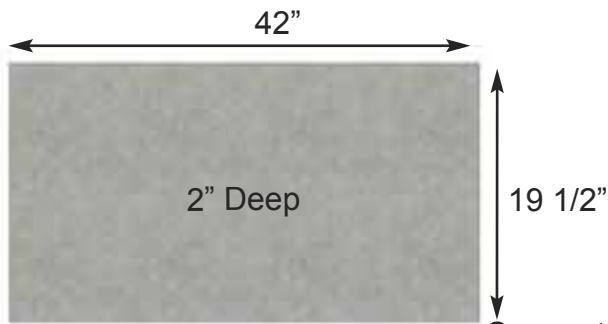

Concrete Foundation

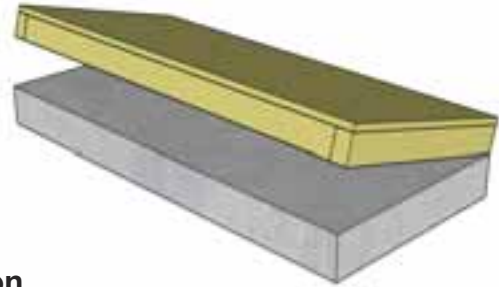

Concrete Slab Foundation:

- Slab must be at least the same size as assembled floor frame (19 1/2" x 42 1/8") or larger.
- 2" Deep foundation.
- 0.4 Cubic Yards of concrete required.
- A concrete slab will have the longest durability out of your foundation options.

Once level, a concrete slab is the easiest surface to build on.

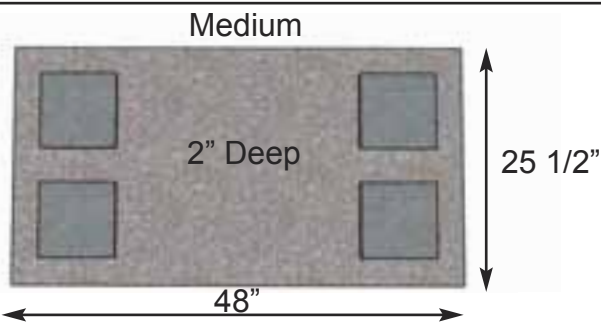

Gravel with Patio Paver Foundation

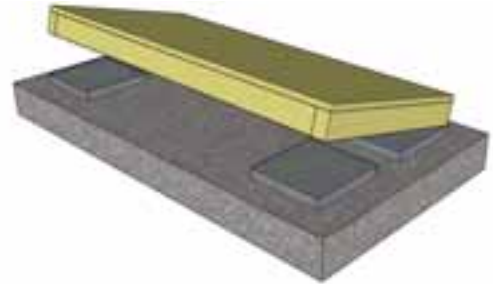

Gravel with Patio Paver Stones:

- Excavate at least 2" deep, and 3" wider than floor frame on each side.
- .05 Cubic Yards of gravel required, approximately 6 - 7 wheelbarrows.
- 4 patio pavers (8" x 8" or larger).
- Center patio paver stones underneath Corners. (19 1/2" x 42 1/8")

Patio paver stones are widely available from most landscape stores.

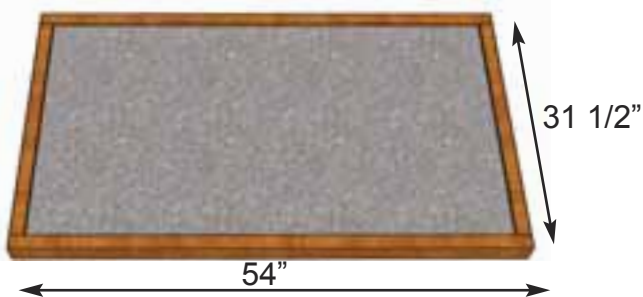

Gravel Foundation with Perimeter

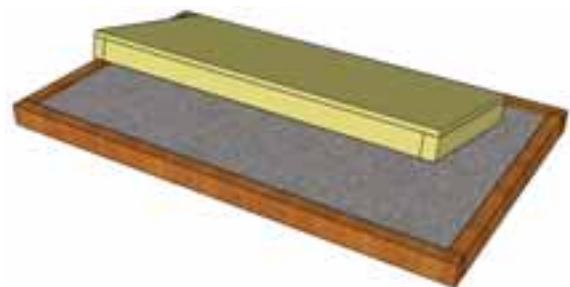

Gravel with Pressure or Treated Wood Perimeter:

- Excavate at least 2" deep, and 6" wider than floor frame on each side.
 - 0.6 Cubic Yards of gravel required, approximately 6 wheelbarrows. (51" x 28 1/2" x 2" deep)
 - 4 - 2x4 Cedar or Pressure Treated Framing Lumber (Approx 2 - 54" and 2 - 28 1/2" pieces).
- * Note - you can also use Patio Paver Stones inside the wooden perimeter.

Perimeter lumber prevents gravel from scattering.

**Thank you for purchasing our 4x2 Garden Chalet.
Please take the time to identify all the parts prior to assembly.**

Parts List	Steps	D. - Trim / Misc. Section Cont.	Steps
A. - Floor Section Floor 1 - Floor Panel - 19 1/2 x 42 1/8"	1	Outer Wall Trim and Fascia 1 - Metal Drip Edge - 38" 2 - Horizontal Trim - 1/2" x 2 1/2" x 45" 2 - Side Fascia - 1/2" x 2 1/2" x 21 3/4" - Angle Cut Ends 3 - Short Corner Trims - 1/2" x 3" x 63 3/8" 3- Long Corner Trims - 1/2" x 3" x 68" 2 - Low Side Trims - 1/2" x 2 1/2" x 63 3/8" - Angle Cut End 2 - High Side Trims - 1/2" x 2 1/2" x 67 3/8" - Angle Cut End	28 - 34
B. - Wall Section Main Wall Panels 2 - Rear Walls - 19 1/2" x 61 3/8" 2 - Side Walls - 19 1/2" x 67" - Angled 4 - Bottom Wall Plates - 1 1/2" x 1 1/2" x 19 1/2" Header/Jambs/Wall Extenders 2 - Door Jambs - 1 1/2" x 1 1/2" x 58 7/8" 1 - Door Header - 1 1/2" x 2 1/2" x 39" 1 - Wall Extender - 6 5/8" x 39" 1 - Low End Top Plate - 1 1/2" x 1 1/2" x 39" Shelves 2 - Support Cleats - 1 1/2" x 1 1/2" x 22 1/2" 4 - Shelf Support - 1 1/2" x 1 1/2" x 20 1/2" - Angled 2 - Storage Shelves - 16 3/8" x 22 1/2"	2 - 8 9 - 15 16 - 19	Door System 2 - Left/Right Doors - 18 3/4" x 59 3/8" 1 - Door Flange - 1/2" x 2 1/2" x 59 3/8" Miscellaneous 1 - Roof Ridge Cap - 1/2" x 3 1/2" x 46" 1 - Above Door Trim - 1/2" x 2 1/2" x 39" (High Front Only) ** Plus 2 Cedar Shingle Shims - discard after shimming doors	35 - 44 45
C. - Roof Section Cedar Roof 1 - Cedar Roof Panel - 23" x 46"	20 - 21		
D. - Trim / Misc. Section Skirting Trim 2 - Front/Rear Skirting - 1/2" x 2 1/2" x 43" 2 - Side Skirting - 1/2" x 2 1/2" x 19 1/2" Filler Trims 2 - Horizontal Filler Strip Bevel - 11/16" x 2" x 39" 2 - Horizontal Filler Trim - 7/8" x 1 1/2" x 39" 8 - Filler Trim - 7/8" x 1 1/2" x 31 3/8"	23 24 - 27	Note: We recommend you drill a 1/8" pilot hole for each screw to avoid splitting wood. The hole depth should be equal to 3/4 the length of screw.	

**Note: Trim and Skirting pieces are graded with the best face being rough sawn.
Rough sawn cedar is much easier to paint and stain.**

4x2 GARDEN CHALET - CEDAR ROOF

Hardware Kit (Provided)

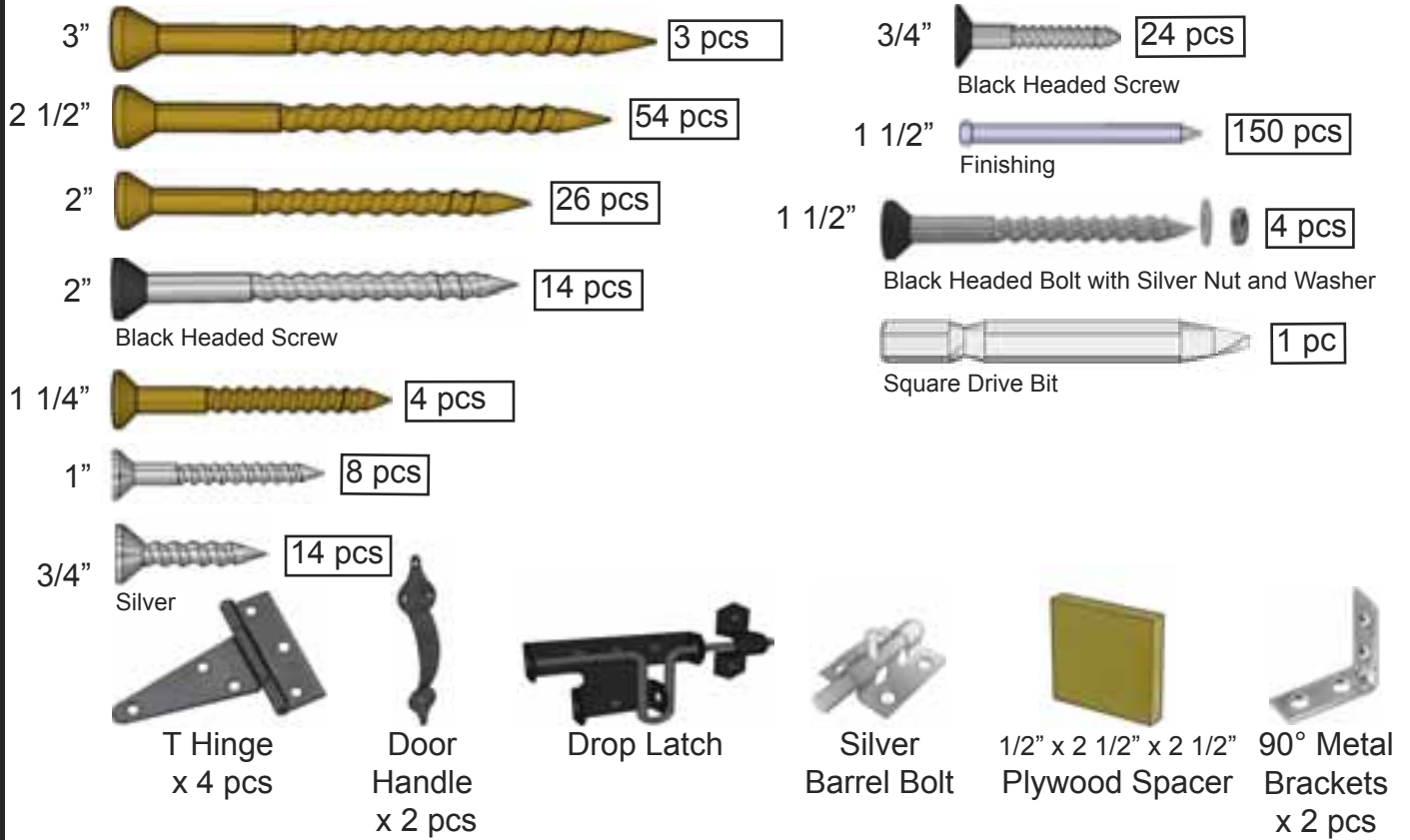

Tools Required (Not Provided)



Safety Equipment Required (Not Provided)



Regular Maintenance & Tips to Prolong the Life of Your Shed.

Before/During Assembly:

- 1.) Paint each face and edge of your plywood floor with a latex exterior paint.
- 2.) Caulk wall seams if gaps appear.
- 3.) Caulk around window framing (if applicable).
- 4.) Caulk perimeter between floor plywood and bottom wall plate.
- 5.) Caulk channels in lap siding at the top of your door above the trim, just a drop in each channel.
- 6.) Caulk edge of door threshold (if applicable).
- 7.) Optional: Install a Sill Gasket between floor runners and foundation.
- 8.) Optional: Install an 8" strip of roofing paper below Cedar Ridge Caps for Cedar Roof Sheds.

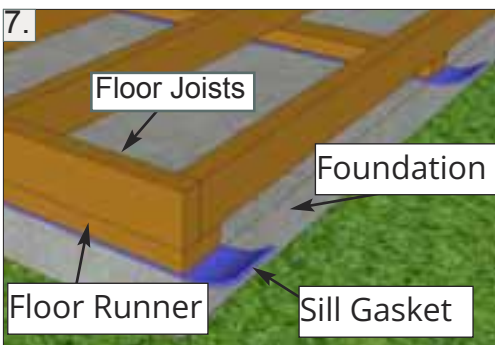
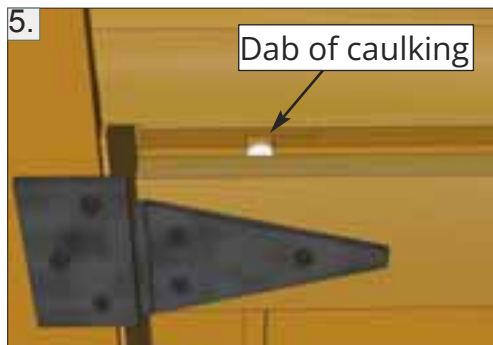
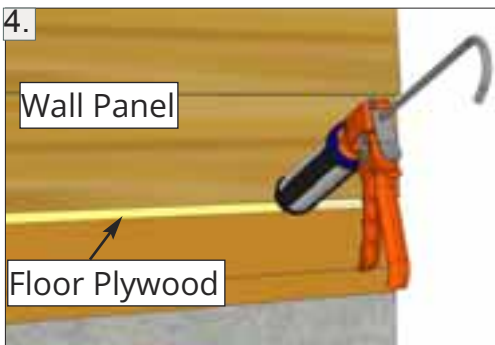
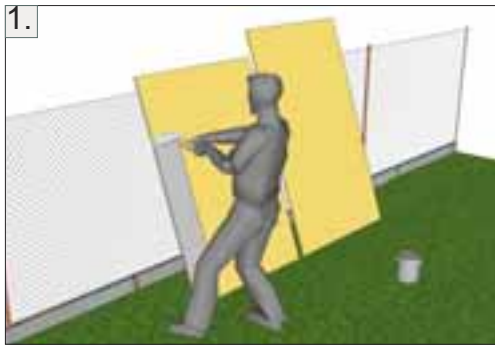

Routine Maintenance:

- Routinely check all fasteners are tight (ex. Door Hinges, Nails)
- Brush off dirt from walls.
- Brush off snow from roof regularly.
- Routinely remove needles and leaves from roof.

Painting/Staining

- Your cedar shed, if left untreated, will weather to a silvery grey colour.
- Painting or staining your structure is highly recommended and will prolong the life of your shed.
- You do not need to wait to paint or stain your shed, the wood in your kit has been dried and can be stained or painted immediately.
- Consult your local paint store for the best paint or stain for cedar.
- Optional: stain the inside of your shed. (Note: this will remove the fresh cedar smell.)

For assembly instructions of your Garden Chalet with a low front, start at page 8.



For assembly instructions of your Garden Chalet with a high front, start at page 31.



A. Floor Section

Exploded view of all parts necessary to complete the Wall Section. Identify all parts prior to starting.

Floor Section

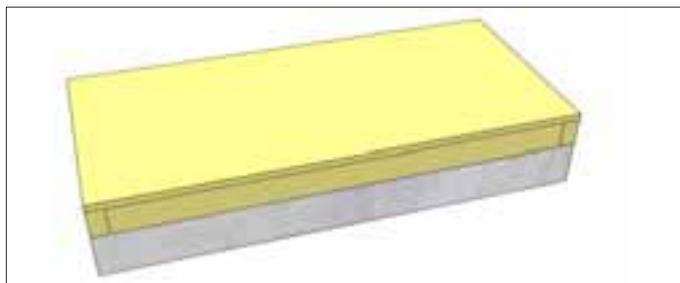
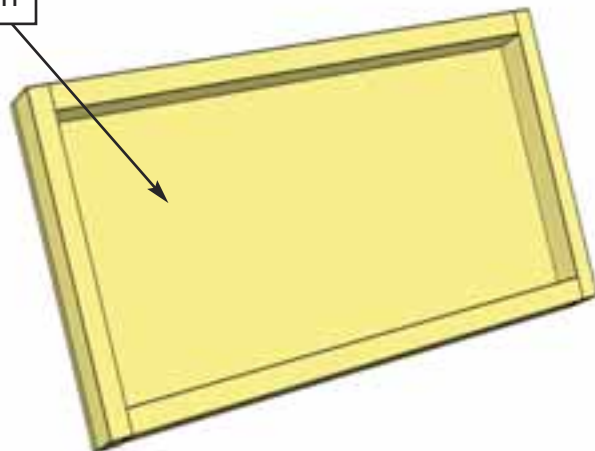

1. Locate **Floor Section** and flip over and lay on a level foundation only. Patio Stones or a Concrete Slab both make excellent foundations. (See Page 3 for more information on foundations). Use a level to confirm and shim Floor frame as required.

Parts
Floor Section
(19 1/2" x 42 1/8") x 1

B. Wall Section

Exploded view of all parts necessary to complete the Wall Section. Identify all parts prior to starting.

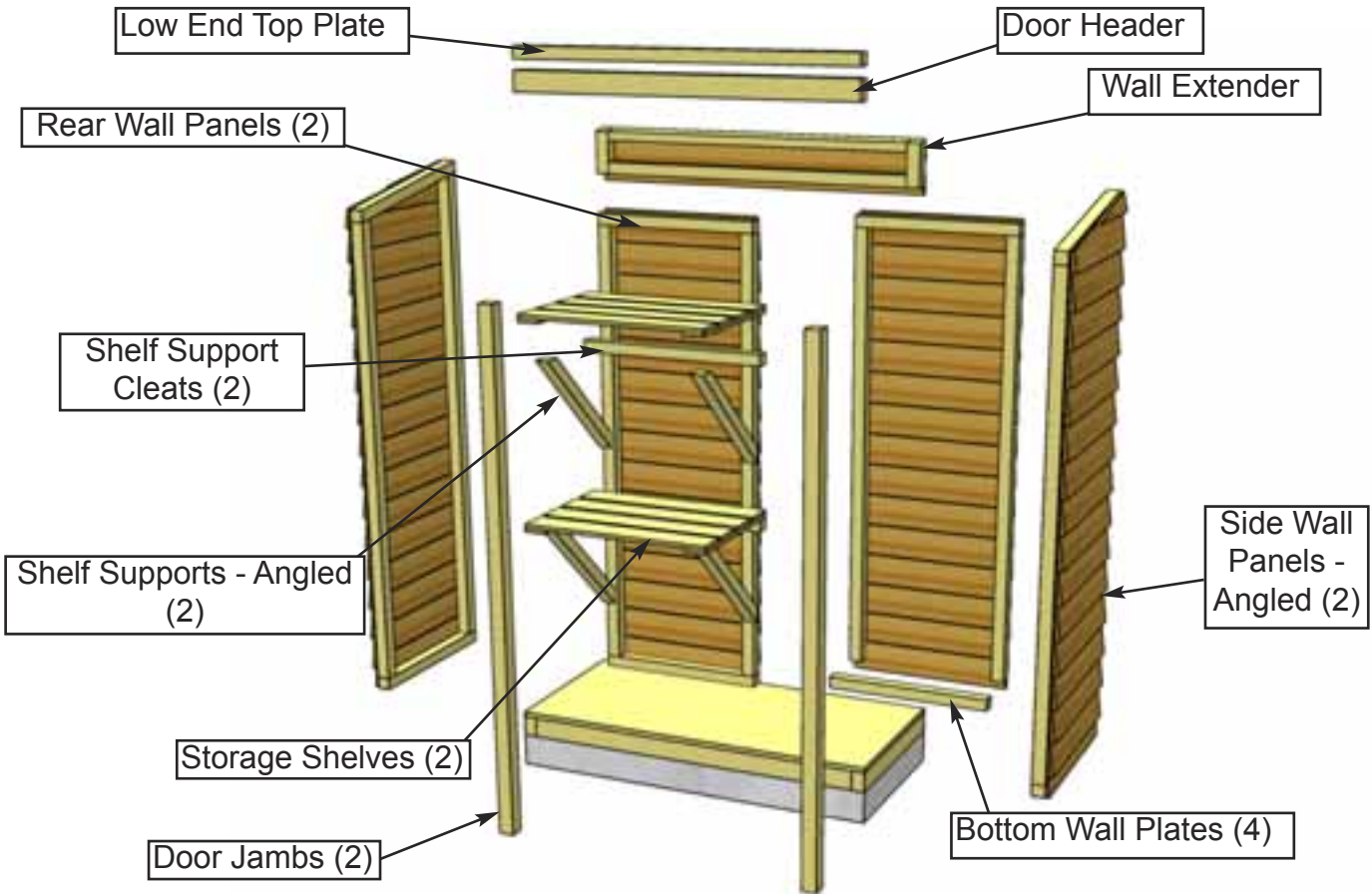

Due to packaging constraints, bottom wall plates must be attached prior to erecting walls.

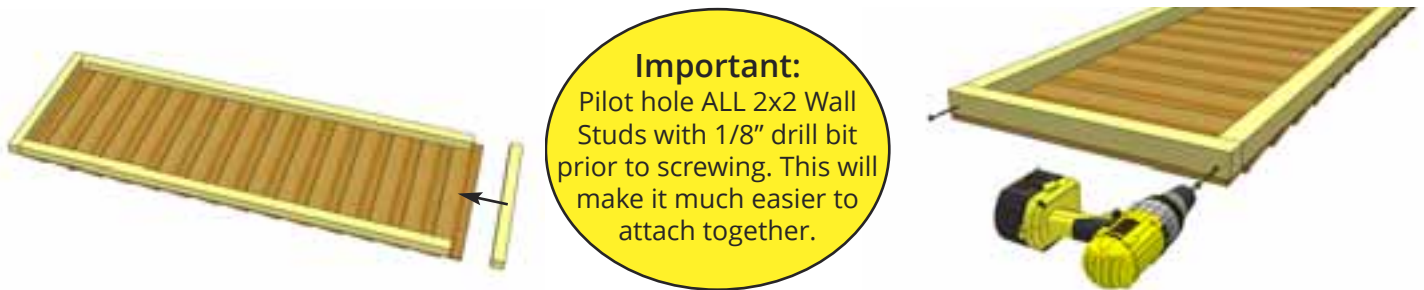

Important:
Pilot hole ALL 2x2 Wall Studs with 1/8" drill bit prior to screwing. This will make it much easier to attach together.

2. For each **Wall Panel**, carefully lay panel face down. Position and attach a **Bottom Wall Plate** to bottom of wall studs of each Wall Panel with 2 - 2 1/2" **Brown Screws**. Position so Plates are flush with framing.

Parts	Hardware
Side Wall Panels - Angled (19 1/2" x 67") x 2	2 1/2" Brown Screws x 8 total
Rear Wall Panels (19 1/2" x 61 3/8") x 2	
Bottom Wall Plates (1 1/2" x 1 1/2" x 19 1/2") x 4	

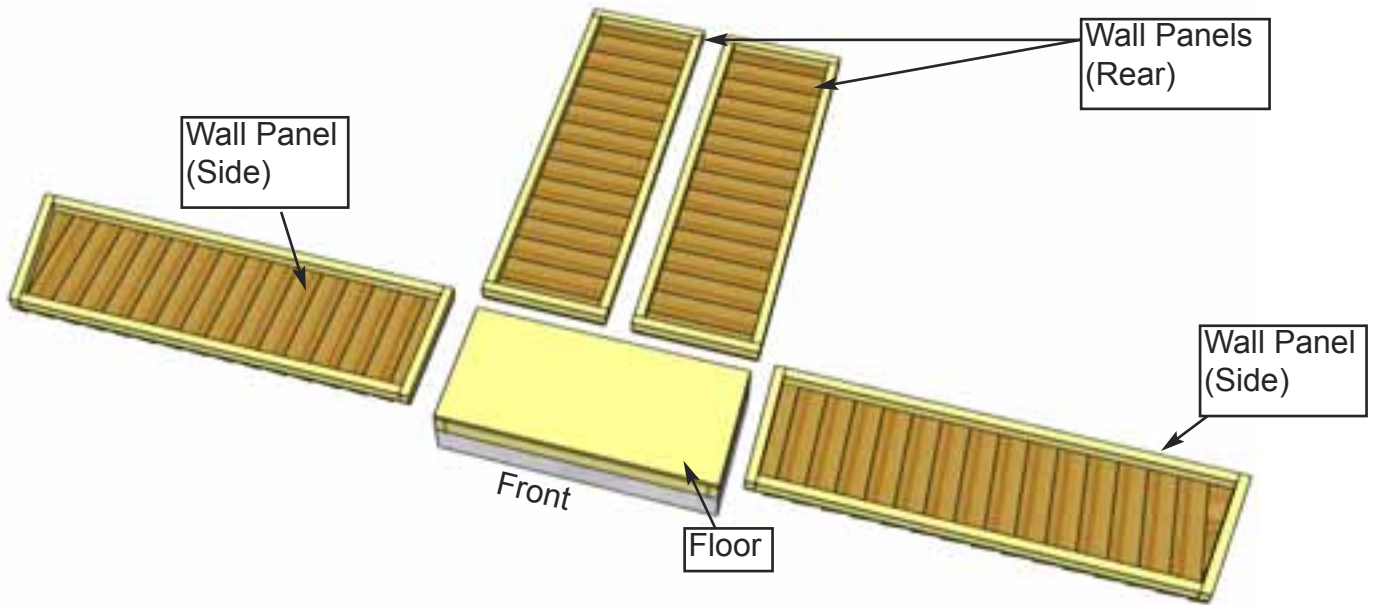

3. With Wall Plates properly attached, orientate completed Walls around the Floor. Be sure to leave room to work.

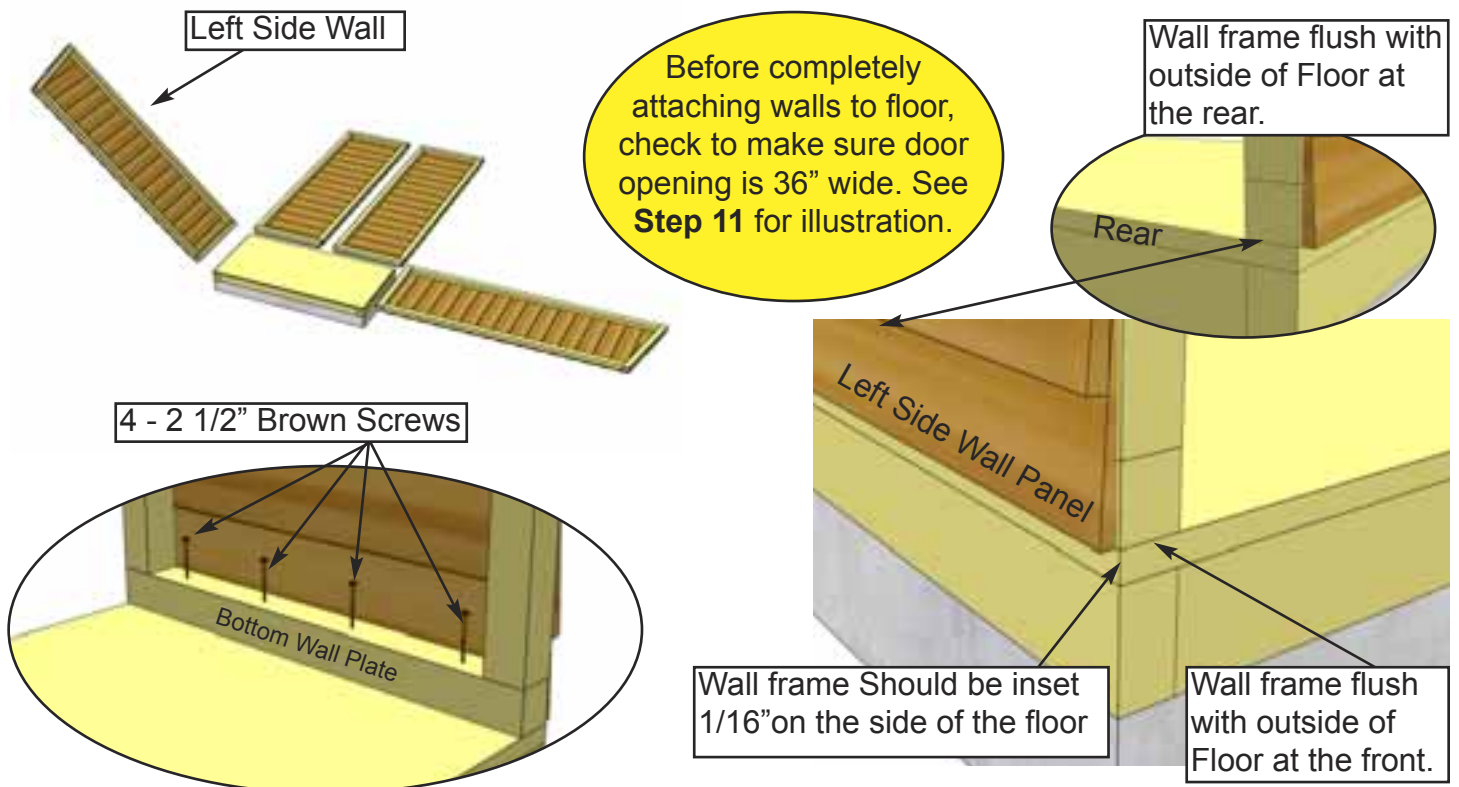

4. Starting with **Left Side Wall**, lift up and position so framing is flush with Floor at both front and rear of shed. Make sure the frame of the wall is inset $1 \frac{1}{16}$ " inside the floor. When Wall is positioned correctly, secure Bottom Wall Plate to Floor with **4 - 2 1/2" Brown Screws**.

Hardware (Steps 4 - 8)
2 1/2" Brown Screws
 x 13 total

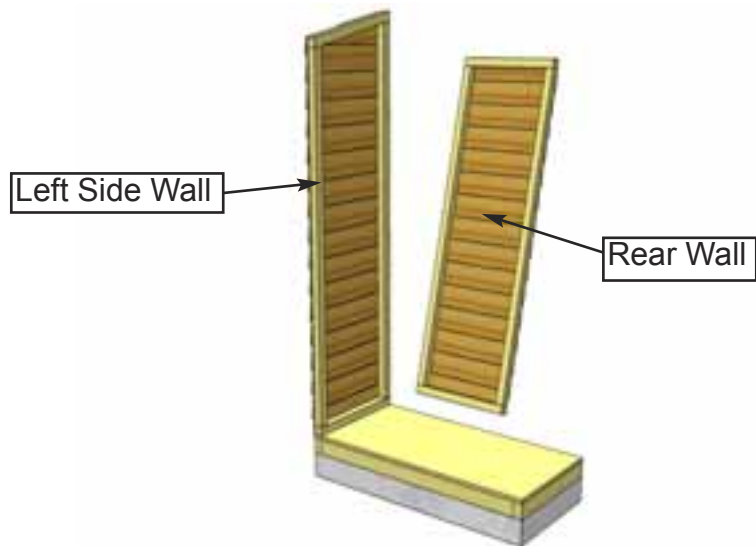

5. With your helper holding the Side Wall Panel, position a **Rear Wall Panel** in rear corner. **Important: Align Wall Framing Flush with Floor Framing.**

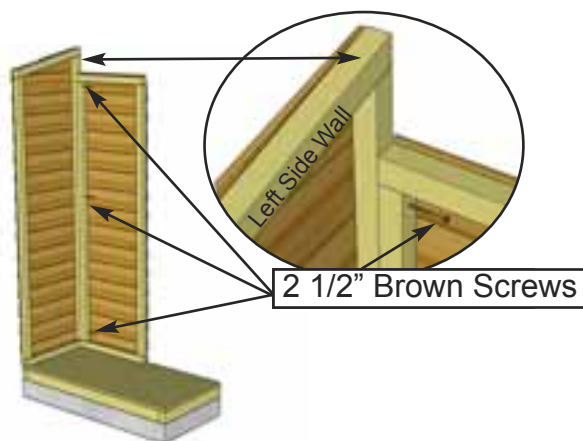
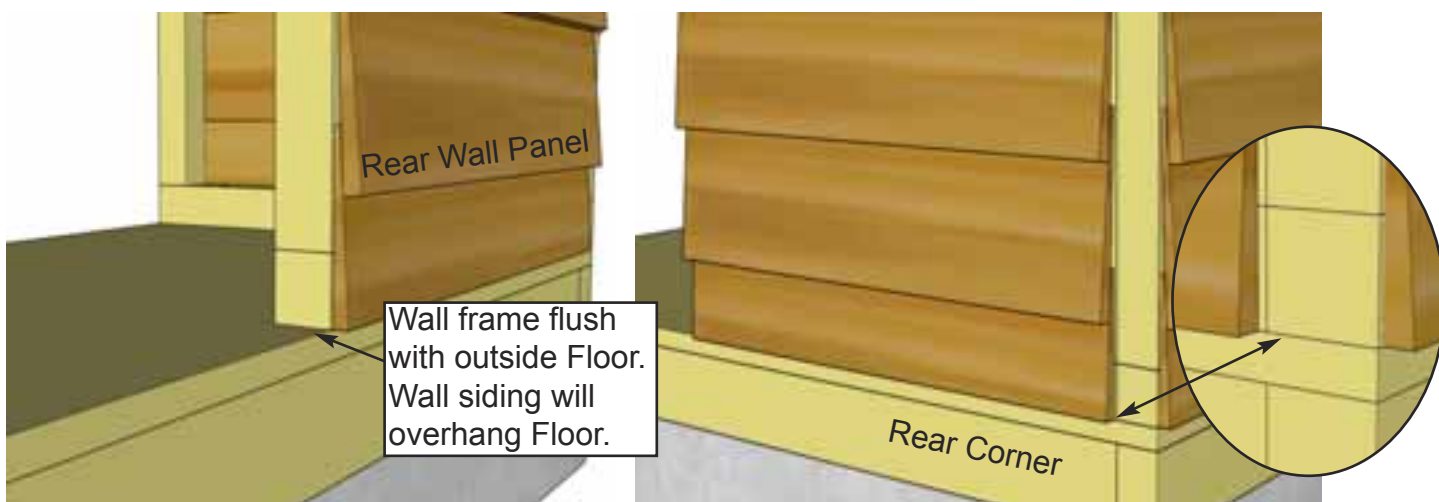

6. When Side and Rear Walls are aligned in corner correctly, Wall framings will be flush. Attach Wall framings together with 3 - 2 1/2" Brown Screws.

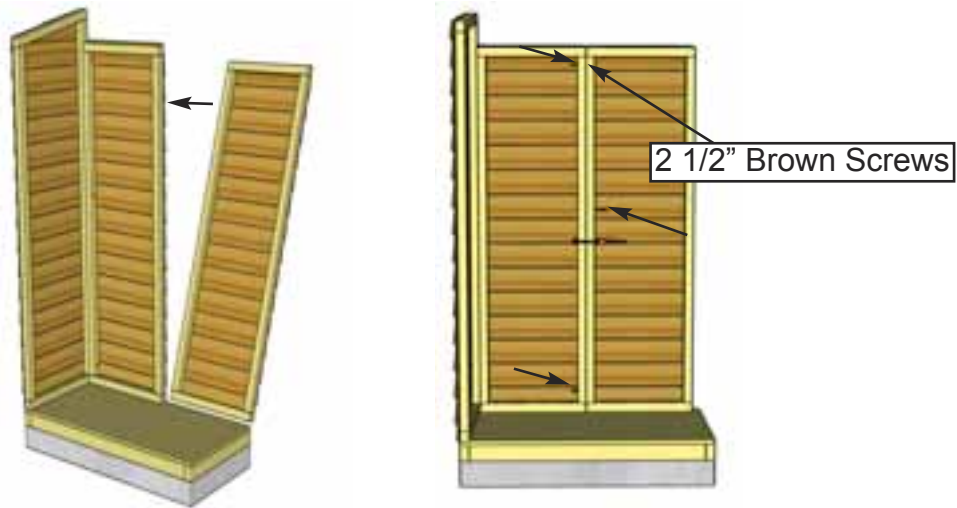

7. Position second **Rear Wall Panel** on Floor as per **Step 6**. Attach Wall frames together at top, middle and bottom with 3 - **2 1/2" Brown Screws**. A wood clamp will be helpful in holding pieces together while fastening. **Important: Confirm Siding on Rear Wall Panels are aligned.**

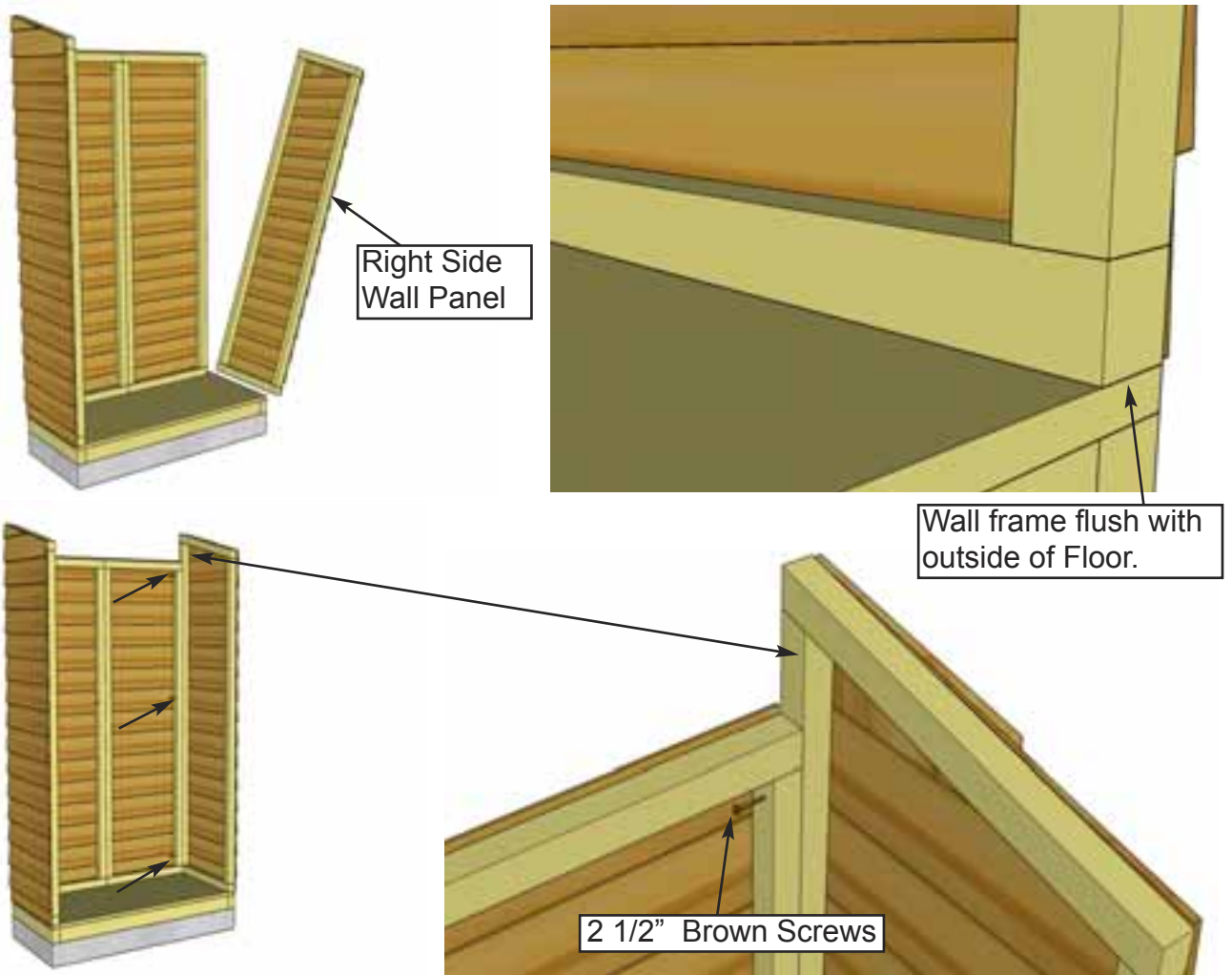

8. In the corner, align and attach Right Side Wall framing to Rear Wall framing with 3 - **2 1/2" Brown Screws** as per **Step 6**.

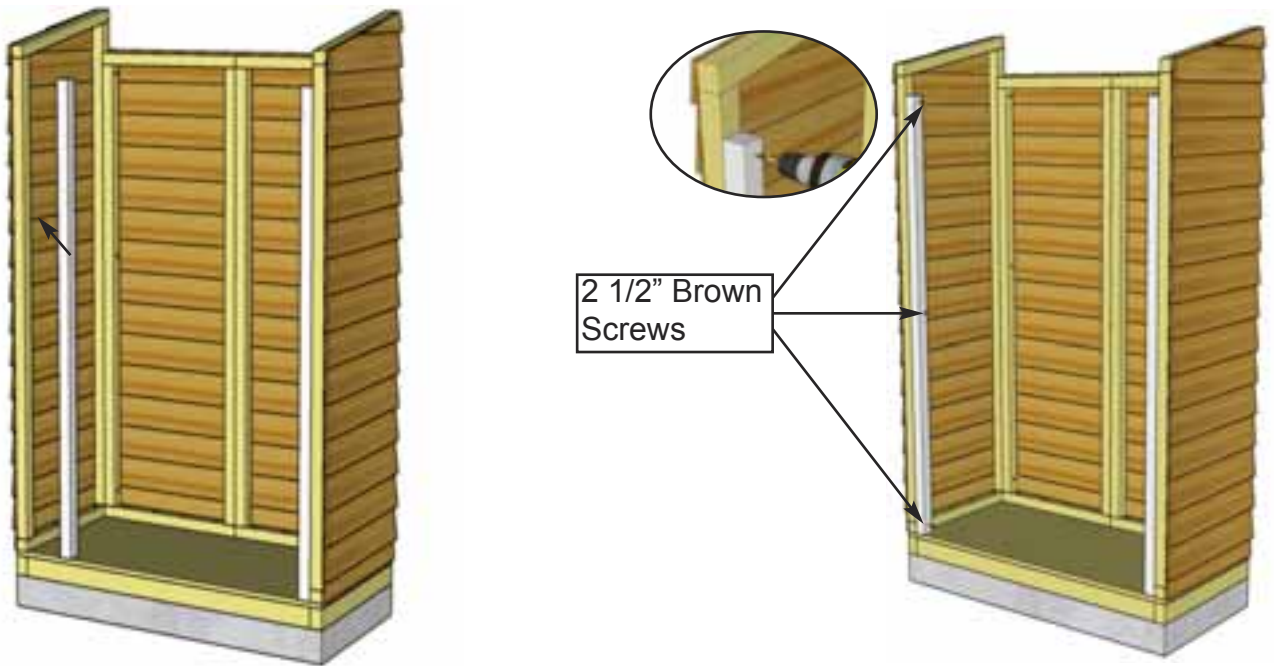

9. Locate both **Door Jambs**. Position each Door Jamb tight to Side Wall framing and flush with the floor. Screw each Door Jamb into wall framing with **3 - 2 1/2" Brown Screws** per piece.

<u>Parts</u> Door Jambs (1 1/2" x 1 1/2" x 58 7/8") x 2	<u>Hardware</u> 2 1/2" Brown Screws x 6 total
--	--

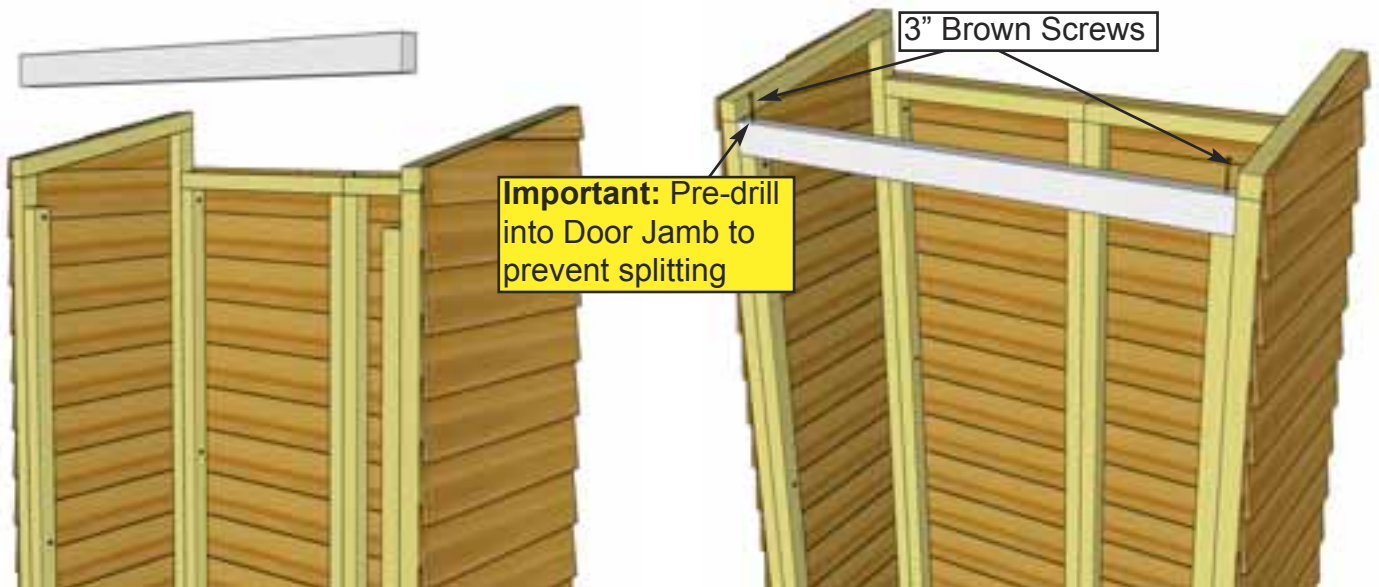

10. Locate **Door Header** and position on top of previously installed Door Jambs. Pilot hole into the Door Jamb with a 1/8" bit to prevent splitting. Secure Door Header to Door Jambs with **2 - 3" Brown Screws**.

<u>Parts</u> Door Header (1 1/2" x 2 1/2" x 39")	<u>Hardware</u> 3" Brown Screws x 2 total
---	--

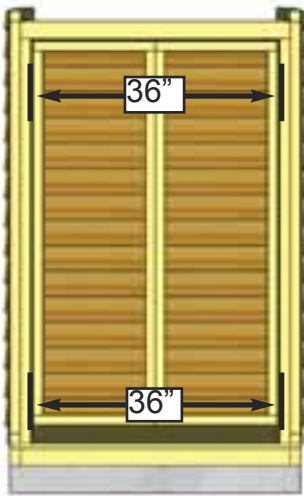

11. With Door Header installed, confirm Door width at both the top and bottom of the doorway. Doorway opening should be 36" wide. If required, loosen screws in Side Walls, adjust Door width and re-secure. There can be a 1/8" tolerance in the width but both top and bottom should match.

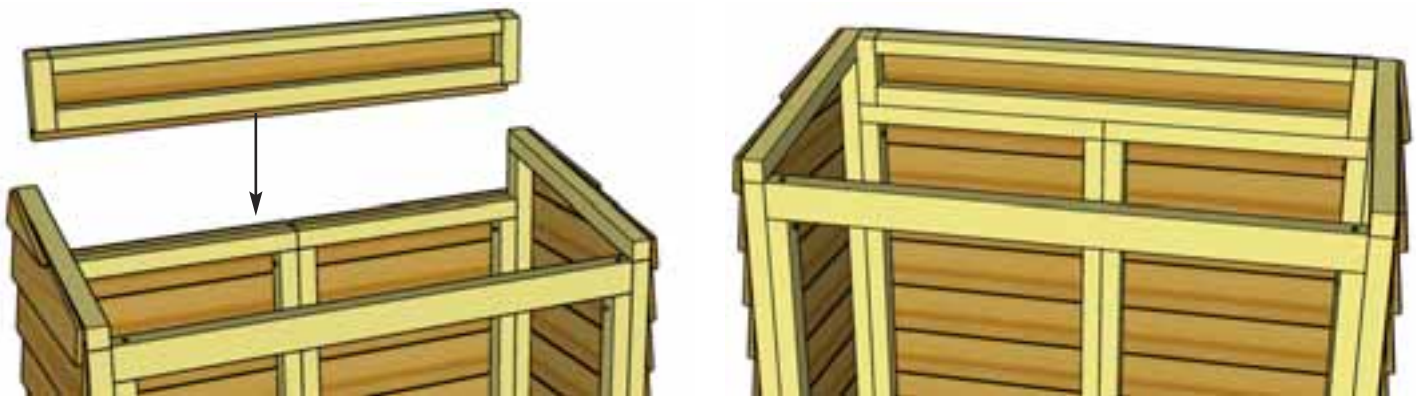

12. Position Wall Extender on top of Rear Walls and in between Angled Side Wall Panels.

<p><u>Parts (Step 12 - 13)</u> Wall Extender (6 5/8" x 39")</p>	<p><u>Hardware (Steps 12 - 13)</u> 2 1/2" Brown Screws x 4 total</p>
--	---

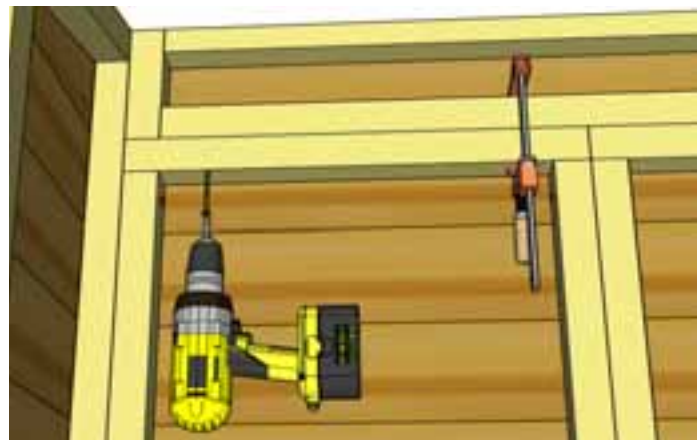

13. Fasten a 2 1/2" Brown Screw through the side into the Angled Side Walls. Angle a second 2 1/2" Brown Screw through the bottom Rear Top Plate into the Wall Extender. Repeat for both sides of shed, fastening to both Rear Wall Top Plates and both Angled Side Walls. A wood clamp will be helpful in holding pieces together while fastening.

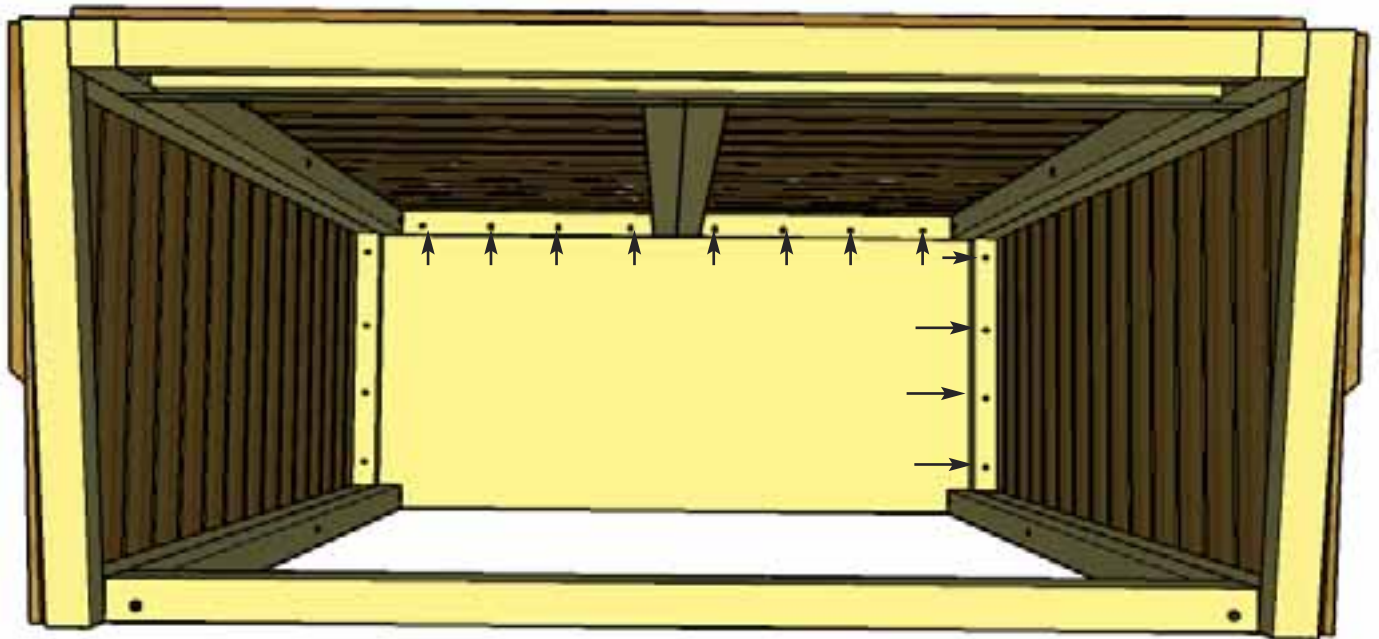

14. With Walls secured, confirm again that the doorway opening is 36". Check interior corner to corner measurements are 42 3/8" across diagonally. With doorway measurement confirmed, begin to fasten Wall Panels down to Floor with 2 1/2" Brown Screws. Use 4 - 2 1/2" **Brown Screws** per Wall Panel. Screw through Bottom Wall Plate into Floor. Note: Left Side Wall has already been fastened down in **Step 4**.

Hardware
2 1/2" Brown Screws
 x 12 total



15. Locate **Low End Top Plate** and position on top of Door Header. Secure Low End Top Plate to Door Header with 4 - 2 1/2" Brown Screws.

<u>Parts</u> Low End Top Plate (1 1/2" x 1 1/2" x 39")	<u>Hardware</u> 2 1/2" Brown Screws x 4 total
---	--



16. Locate **Shelf Support Cleats**. Each Shelf requires one Support Cleat and these will set the height of your Shelves. We recommend 25 1/4" from the Floor for the first one and 45 1/2" from the Floor for the second. These can be adjusted as you wish but leave 18 3/4" of space between the Cleats. Attach Shelf Support Cleats to Rear Wall with 2 - 2 1/2" Brown Screws per Cleat.

<u>Parts</u> Shelf Support Cleats (1 1/2" x 1 1/2" x 22 1/2") x 2	<u>Hardware</u> 2 1/2" Brown Screws x 4 total
--	--

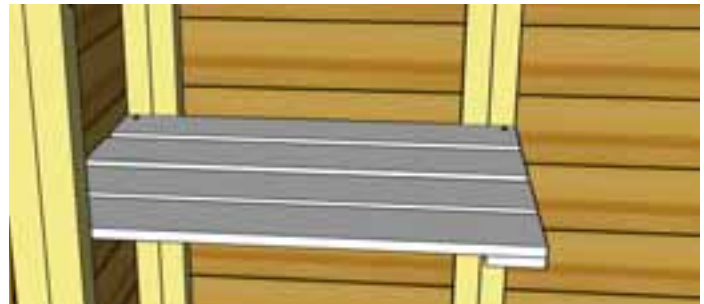

17. Place one **Shelf** on top of Shelf Support Cleat. Have a helper hold the shelf in place while you attach it. Drill 2 - 2" Brown Screws through Shelf into Shelf Support Cleat.

<u>Parts</u> Shelf (16 3/8" x 22 1/2")	<u>Hardware</u> 2" Brown Screws x 2 total
---	--



18. Place two **Shelf Supports** underneath Shelf. Drill 2 - **2" Brown Screws** through Shelf Support into underside of Shelf at the top and through Shelf Support into Rear Wall Framing at the bottom.

<u>Parts</u> Shelf Supports - Angled (1 1/2" x 1 1/2" x 20 1/2") x 2	<u>Hardware</u> 2" Brown Screws x 4 total
---	--



19. Attach second **Shelf** as per **Steps 17-18**. Have a helper hold the shelf in place while you attach it.

<u>Parts</u> Shelf (16 3/8" x 22 1/2") Shelf Supports - Angled (1 1/2" x 1 1/2" x 20 1/2") x 2	<u>Hardware</u> 2" Brown Screws x 6 total
--	--

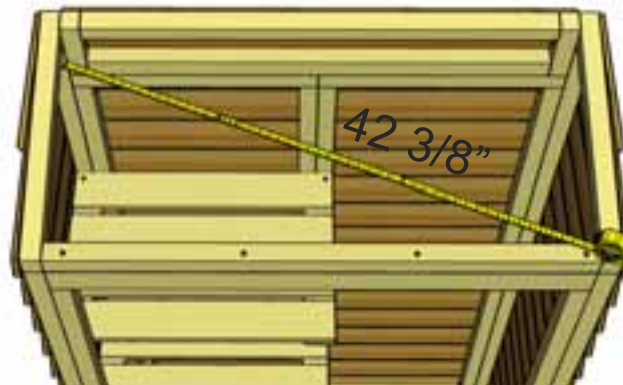

Before Roof Section, once again take a diagonal measurement in both directions and square up the shed. If diagonal measurement is more than 1/8" different between sides, try pushing corner of shed in or out.

C. Roof Section

Exploded view of all parts necessary to complete the Roof Section. Identify all parts prior to starting.

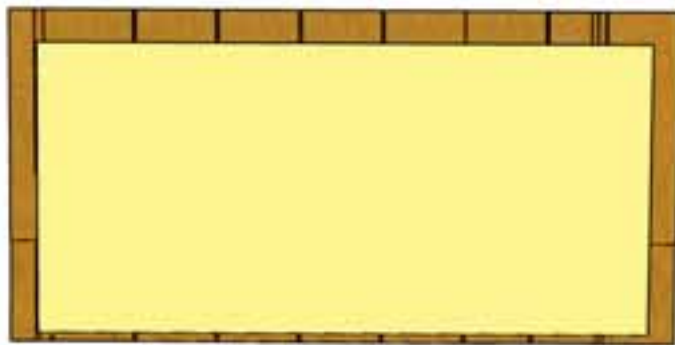

Cedar Shingle Roof Panel

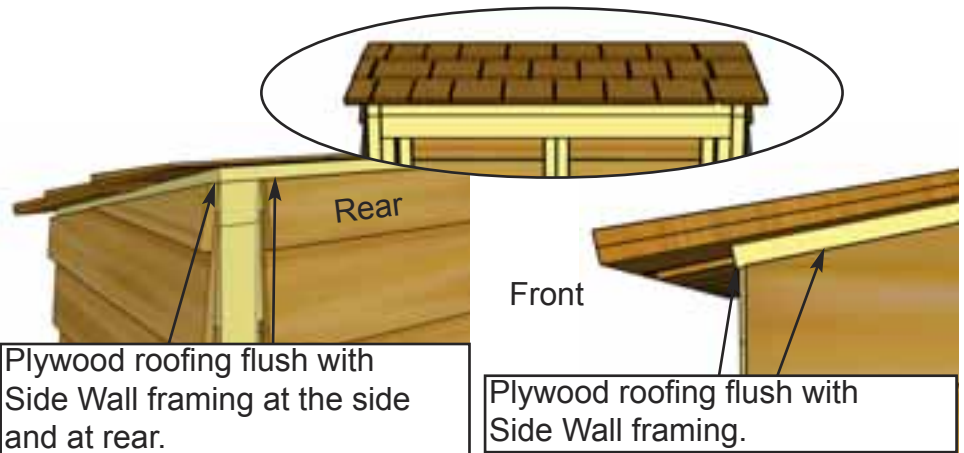

20. Lift up Cedar Shingle Roof Panel and place on upper wall framing. At the rear, align plywood roofing flush with Side Wall framing at the side and at the rear. At the front, align plywood roofing flush with Side Wall framing.

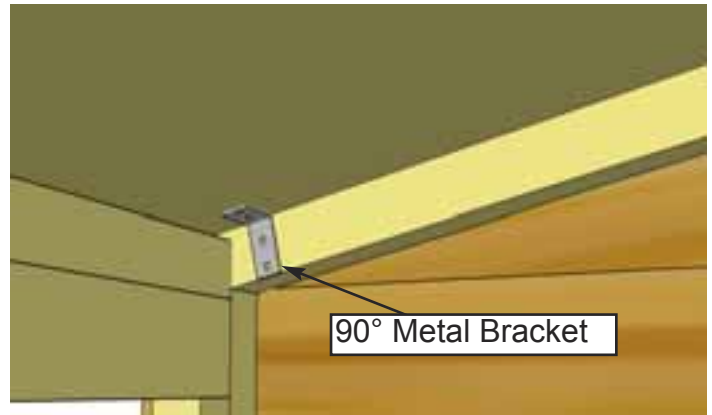
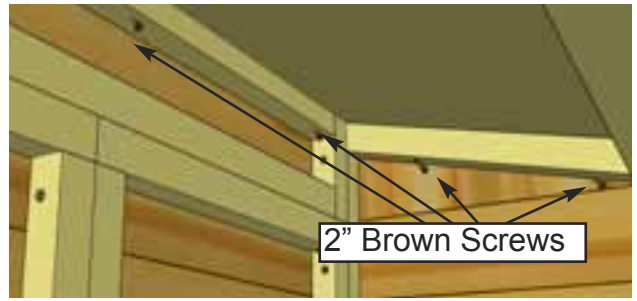
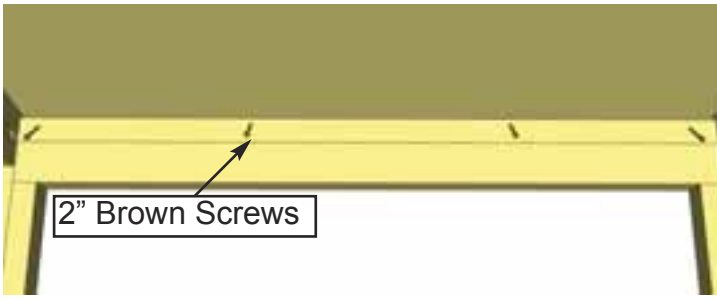

21. From inside the shed, start securing the Roof by screwing through Low End Top Plate into Roof Panel on an angle with 4 - **2" Brown Screws**. Make sure screw tips do not go completely through Roof Panel. At the sides, screw from upper framing into Roof Panel. Use 2 - **2" Brown Screws** per Side Angled Wall. Screw on an angle and make sure screw tips do not go completely through Roof Panel. At the rear, secure the Roof by attaching the Wall Extender to Roof Panel on an angle with 4 - **2 1/2" Brown Screws**. Further secure Roof Panel to Walls at sides by positioning 2 - **90° Metal Brackets** onto Roof Plywood and Side Angled Walls where Side Angled Wall meets front Wall. Secure with 4 - **3/4" Silver Screws** per bracket.

<u>Parts</u>	<u>Hardware</u>
Cedar Shingle Roof Panel (23" x 46")	2" Brown Screws x 12 total 90° Metal Brackets x 2 total 3/4" Silver Screws x 8 total



22. Check the Wall seams for visible gaps prior to attaching Filler Trim and apply caulk where needed. Caulking gaps will help prevent moisture from entering and will help the longevity of your shed. **Caulking not included in kit.**

E. Miscellaneous Section

Exploded view of all parts necessary to complete the Skirting, Trim, Fascia and Miscellaneous Pieces. Identify all parts prior to starting.

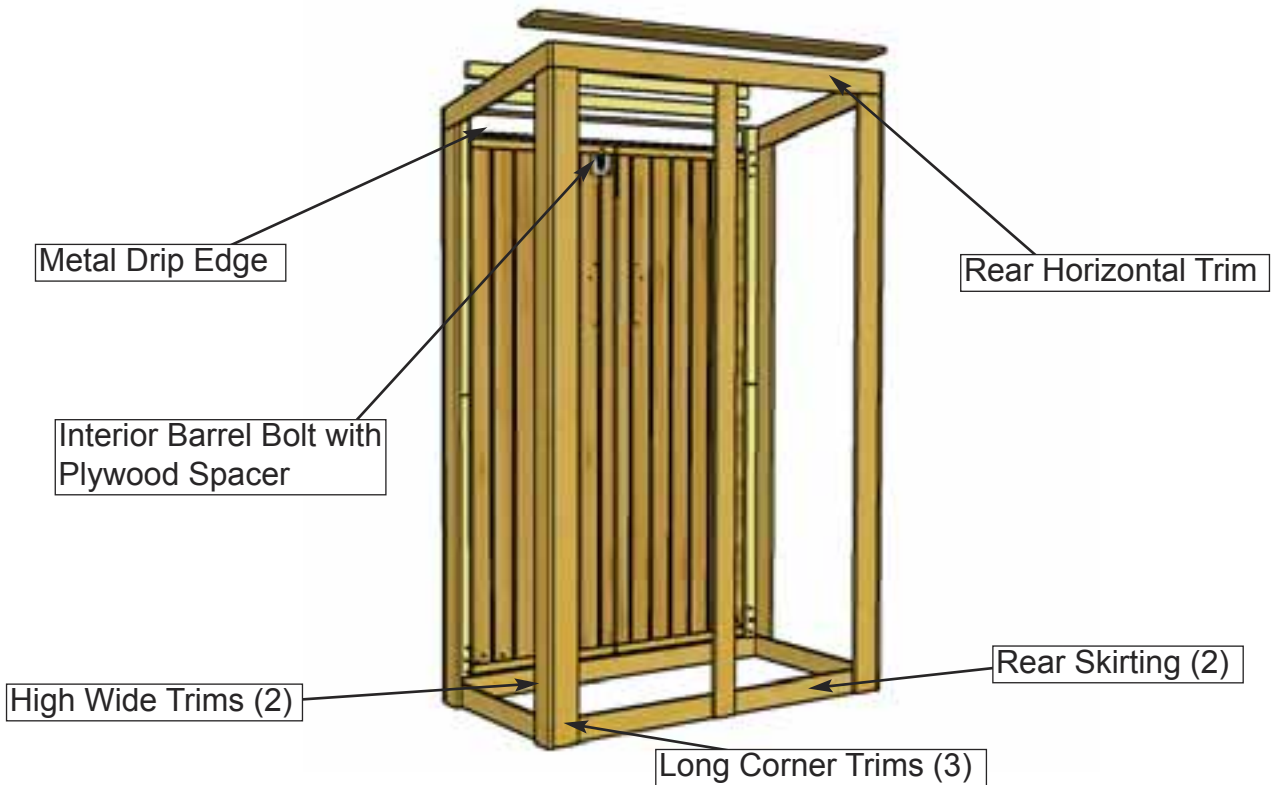
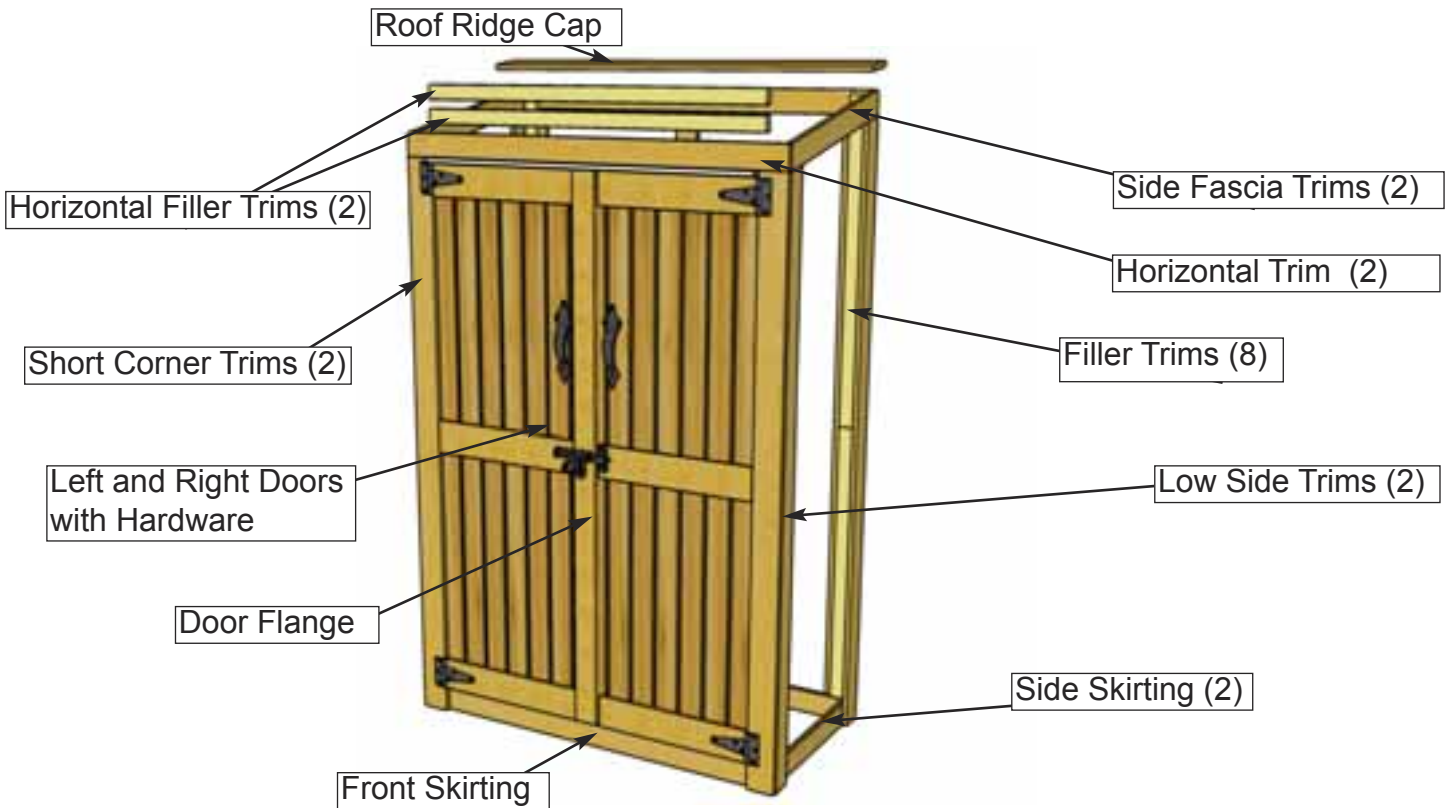

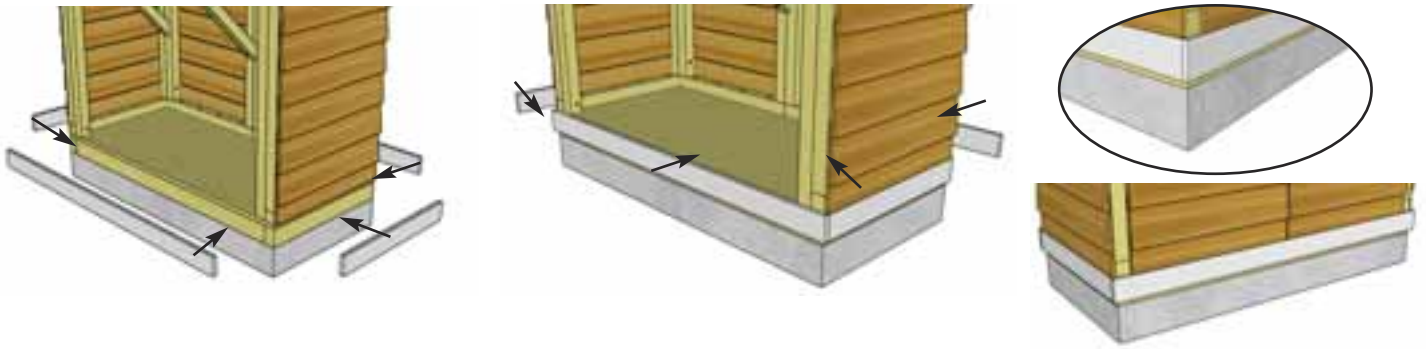

23. Locate **Front/Rear Skirting**. Skirting will hide Floor framing and gaps will be covered by Wide Trim pieces later. Attach Front/Rear Skirting pieces with **6 - 1 1/2" Finishing Nails** per piece. Locate **Side Skirting** and attach with **4 - 1 1/2" Finishing Nails** per piece.

<u>Parts</u> Front/Rear Skirting (1/2" x 2 1/2" x 43") x 2 Side Skirting (1/2" x 2 1/2" x 19 1/2") x 2	<u>Hardware</u> 1 1/2" Finishing Nails x 20 total
--	--

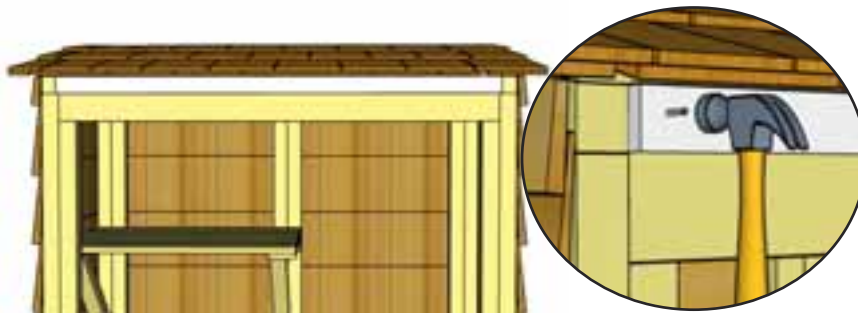

24. Locate **Horizontal Filler Trims**. Position first Horizontal Filler Trim on Low End Top Plate. Evenly space from side to side. Secure with **6 - 1 1/2" Finishing Nails** into Low End Top Plate.

<u>Parts (Steps 24 - 25)</u> Horizontal Filler Trim (7/8" x 1 1/2" x 39") x 2	<u>Hardware (Steps 24 - 25)</u> 1 1/2" Finishing Nails x 12 total
--	--

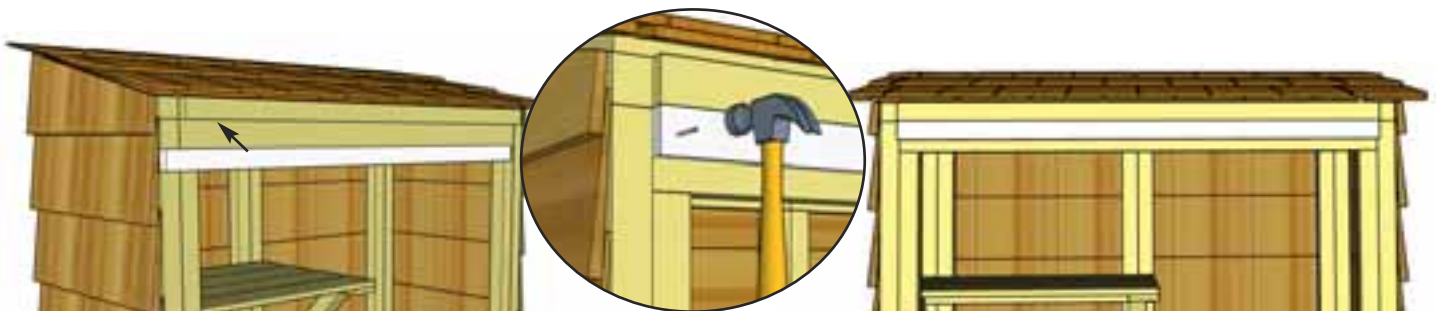

25. Locate second **Horizontal Filler Trim** and position on Door Header underneath first Filler Trim. Evenly space from side to side. Secure with **6 - 1 1/2" Finishing Nails** into Door Header.



26. Locate 4 **Filler Trims**. Filler trim will be covered by Corner Trim in **Step 31**. Attach in each corner with **3 - 1 1/2" Finishing Nails** per piece.

<p><u>Parts (Step 26 - 27)</u> Filler Trims (7/8" x 1 1/2" x 31 3/8") x 8</p>	<p><u>Hardware (Step 26 - 27)</u> 1 1/2" Finishing Nails x 24 total</p>
--	--

<p><u>Parts (Step 26 - 27)</u> Filler Trims (7/8" x 1 1/2" x 31 3/8") x 8</p>	<p><u>Hardware (Step 26 - 27)</u> 1 1/2" Finishing Nails x 24 total</p>
--	--

Place High Side Filler Trim at the top

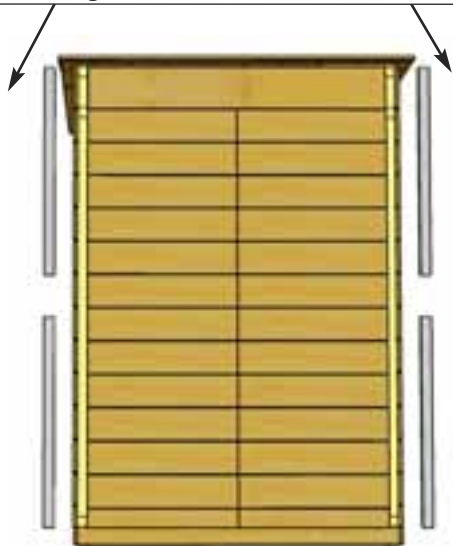

27. Position and attach 2 more **Filler Trims** at the rear as per **Step 26**. **Note: High Side Filler Trims will have a gap in between when installed, this will be covered with trim in Step 34.**



28. Position and attach **Horizontal Filler Strip Bevel** at the rear of the shed to create a flat surface.

<p><u>Parts (Step 26 - 27)</u> Horizontal Filler Strip Bevel (11/16" x 2" x 39") x 1</p>	<p><u>Hardware (Step 28)</u> 1 1/2" Finishing Nails x 6 total</p>
---	--

<p><u>Parts (Step 26 - 27)</u> Horizontal Filler Strip Bevel (11/16" x 2" x 39") x 1</p>	<p><u>Hardware (Step 28)</u> 1 1/2" Finishing Nails x 6 total</p>
---	--

Expert Advice:
 Do a dry run with Trims before attaching. Confirm the rough face is configured correctly and small trim gaps are satisfactory before attaching.



29. Locate **Metal Drip Edge** and **Horizontal Trim**. Position Metal Drip Edge onto Horizontal Filler Trims. Have a helper hold down Metal Drip Edge and place Front Horizontal Trim on top of Metal Drip Edge. Evenly space from side to side and secure with **6 - 1 1/2" Finishing Nails**.

<u>Parts</u> Metal Drip Edge (38") Horizontal Trim (1/2" x 2 1/2" x 45")	<u>Hardware</u> 1 1/2" Finishing Nails x 6 total
---	---



30. Locate **Side Fascia Trim**. Position Side Fascia underneath Cedar Roof and attach to Angled Wall Panel with **4 - 1 1/2" Finishing Nails**.

<u>Parts</u> Side Fascia Trim (Angle Cut Both Ends) (1/2" x 2 1/2" x 21 3/4")	<u>Hardware</u> 1 1/2" Finishing Nails x 4 total
--	---

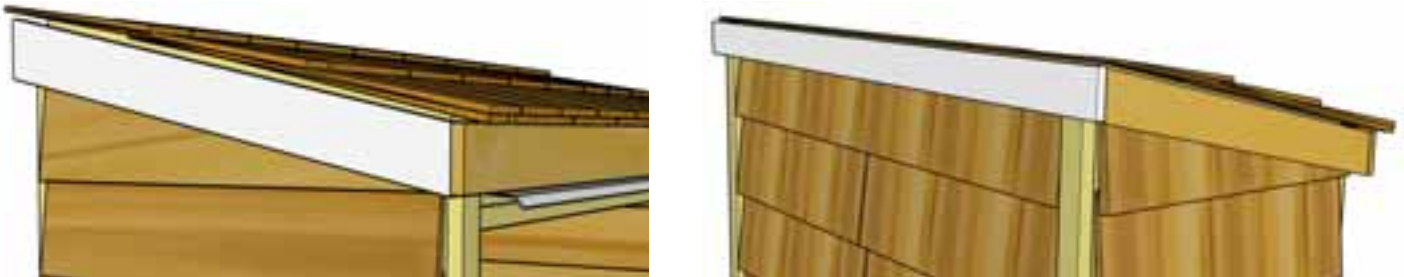

31. Attach second **Side Fascia** and **Horizontal Trim** as per Steps 29 - 30.

<u>Parts</u> Side Fascia Trim (Angle Cut Both Ends) (1/2" x 2 1/2" x 22 1/8") Horizontal Trim (1/2" x 2 1/2" x 45")	<u>Hardware</u> 1 1/2" Finishing Nails x 6 total
---	---

Expert Advice:
 Do a dry run with trims before attaching. Confirm the rough face is configured correctly and small trim gaps are satisfactory before attaching.



32. Locate **Short Corner Trim** and **Low Side Trims**. Position first Short Corner and Low Side Trims underneath Horizontal Trim and Side Fascia. Short Corner Trims will cap Low Side Trims. Attach each piece with 6 - 1 1/2" Finishing Nails.

<p><u>Parts (Step 32 - 33)</u> Short Corner Trims (1/2" x 3" x 63 3/8") x 2 Low Side Trims (Angle Cut) (1/2" x 2 1/2" x 63 3/8") x 2</p>	<p><u>Hardware (Step 32 - 33)</u> 1 1/2" Finishing Nails x 24 total</p>
--	--



33. Attach second **Low Wide** and **Low Side Trims** as per Step 31.

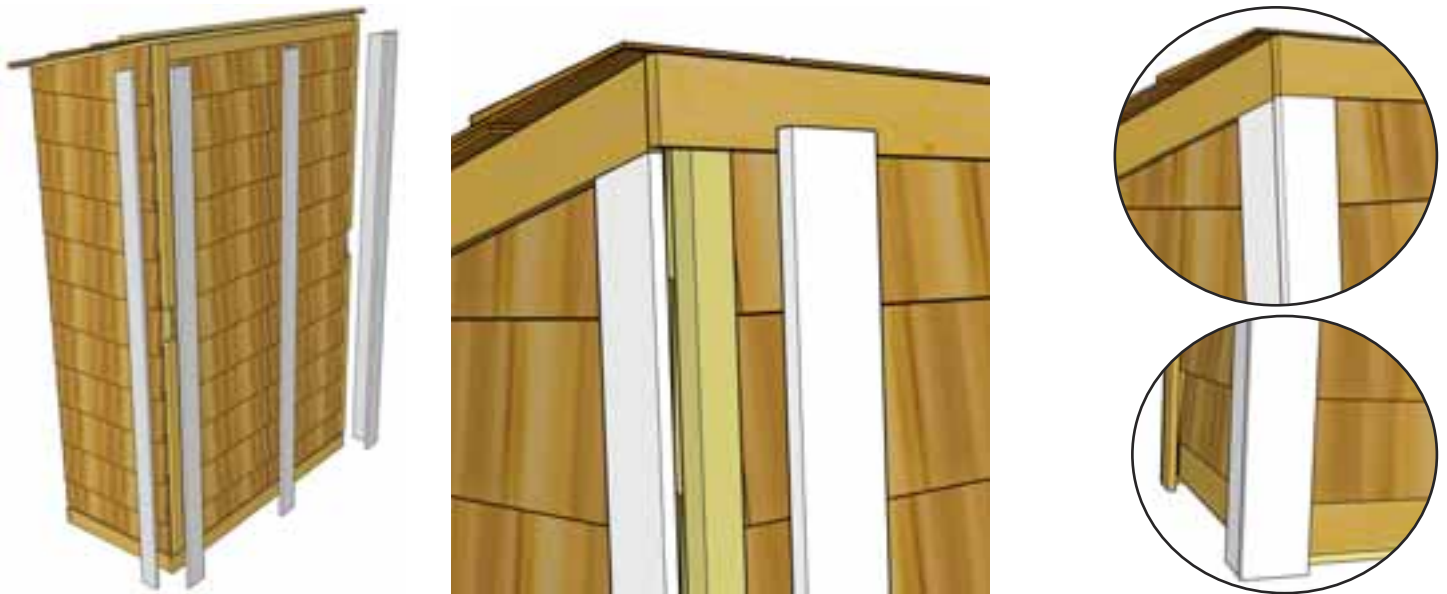

34. Locate **Long Corner Trims, High Side Trims**. Starting in one corner, position Long Corner and High Side Trims up tight underneath rear Horizontal Trim and Side Fascia Trim. Long Corner Trim will cap High Side Trim . When correctly aligned, attach each piece with **6 - 1 1/2" Finishing Nails**.

Parts (Step 34 - 35)
Long Corner Trim
 (1/2" x 3" x 68") x 3
High Side Trim (Angle Cut)
 (1/2" x 2 1/2" x 67 3/8") x 2

Hardware (Step 34 - 35)
1 1/2" Finishing Nails
 x 30 total



35. Place **Long Corner Trim** tight against the rear Horizontal Trim and attach with **6 - 1 1/2" Finishing Nails**. Attach second **Long Corner Trim** and **High Side Trim** as per **Step 34**.

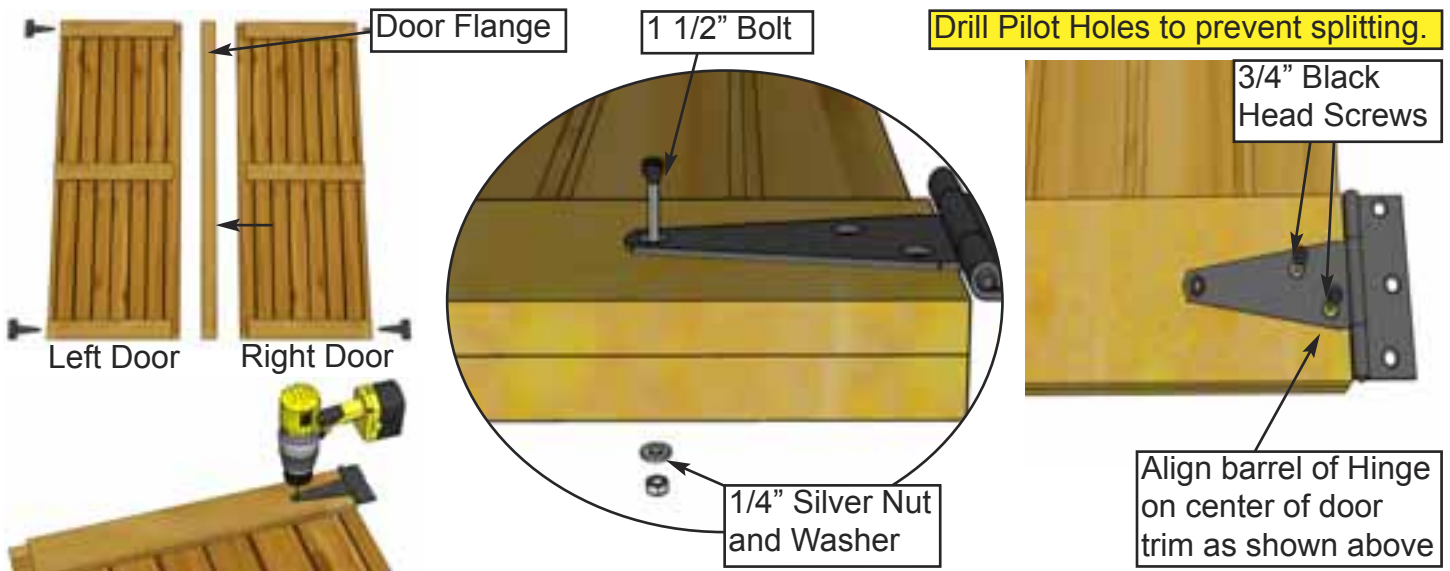

35. Locate **Left** and **Right Doors** and **Door Flange**. Orientate Doors so the outside of each Door is facing up. Locate **Black T Hinges**. Prior to attaching, position Hinges equally on Door trim as shown above and with a 1/8" drill bit, drill a hole through the tip of the Hinge and all the way through the Door. Complete for all 4 hinges. Attach each Hinge to Door as above with 1 - 1 1/2" **Black Headed Bolt**, and a 1/4" **Silver Nut** and **Washer**, using a 3/8" wrench. Finish Hinge by securing with 2 - 3/4" **Black Headed Screws**. Drill small pilot holes first to prevent wood from splitting. Complete both Doors (4 Hinges).

<p><u>Parts (Step 35 - 39)</u> Left and Right Doors (18 3/4" x 59 3/8") Door Flange (1/2" x 2 1/2" x 59 3/8")</p>	<p><u>Hardware (Step 35 - 39)</u> Black T Hinge x 4 total 1 1/2" Black Headed Bolt x 4 total 1/4" Silver Nut and Washer x 4 total 3/4" Black Headed Screws x 8 total 1" Silver Screws x 6 total 2" Black Headed Screws x 12 total</p>
---	---

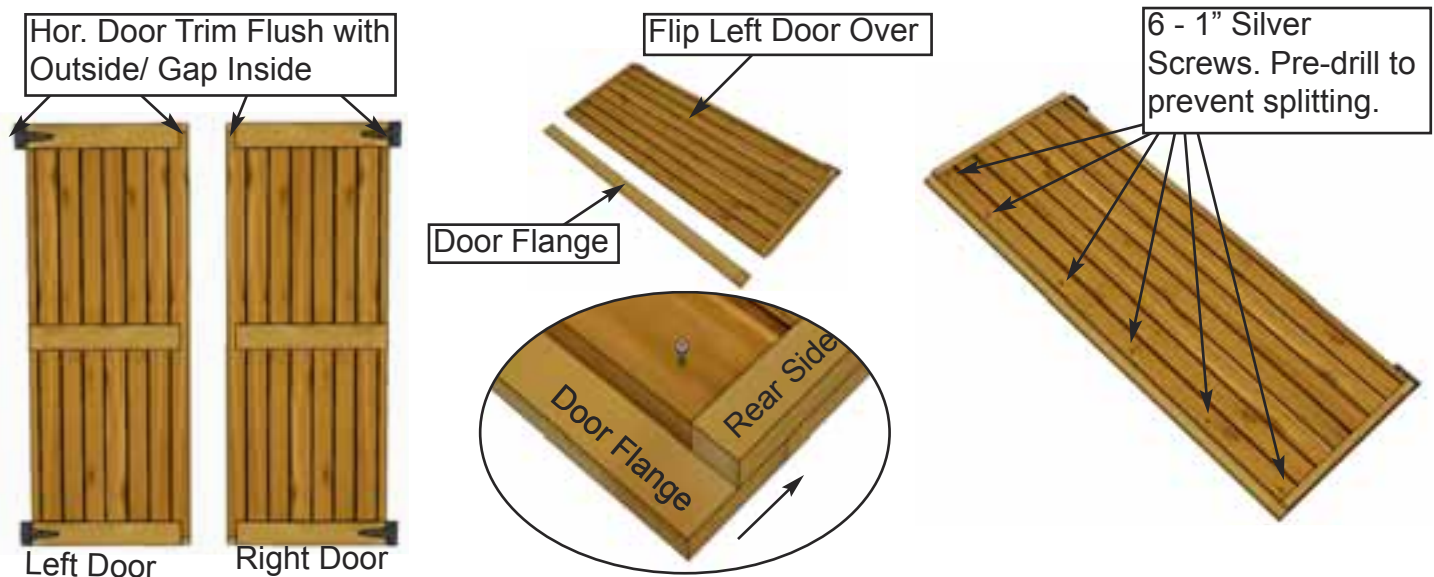

36. Flip Left Door over to attach **Door Flange**. Position Door Flange tight against horizontal trim and even with trim on top and bottom. If out slightly, make sure top horizontal trim and Flange are even. Pre-drill with 1/8" bit to prevent wood from splitting. Attach with 6 - 1" **Silver Screws**.

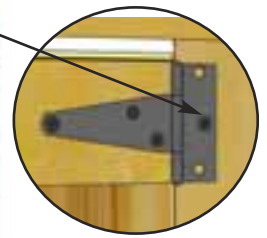
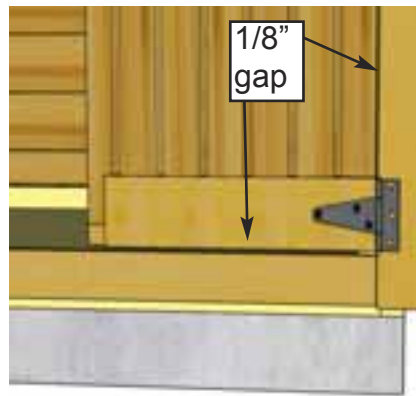

1 - 2" Screw per Hinge Initially.

37. Starting with Right Door first, lift and position Door in opening. Leave a 1/8" gap on right side and 1/8" gap on the bottom. Use a **Cedar Shingle Shim** to shim the Door at bottom to help position door evenly. When Door is aligned correctly, screw Hinge into Low Wide Trim with 1 - 2" **Black Headed Screws**. Use only 1 screw initially per Hinge until both Door alignments are confirmed. Drill pilot holes to prevent wood from splitting.

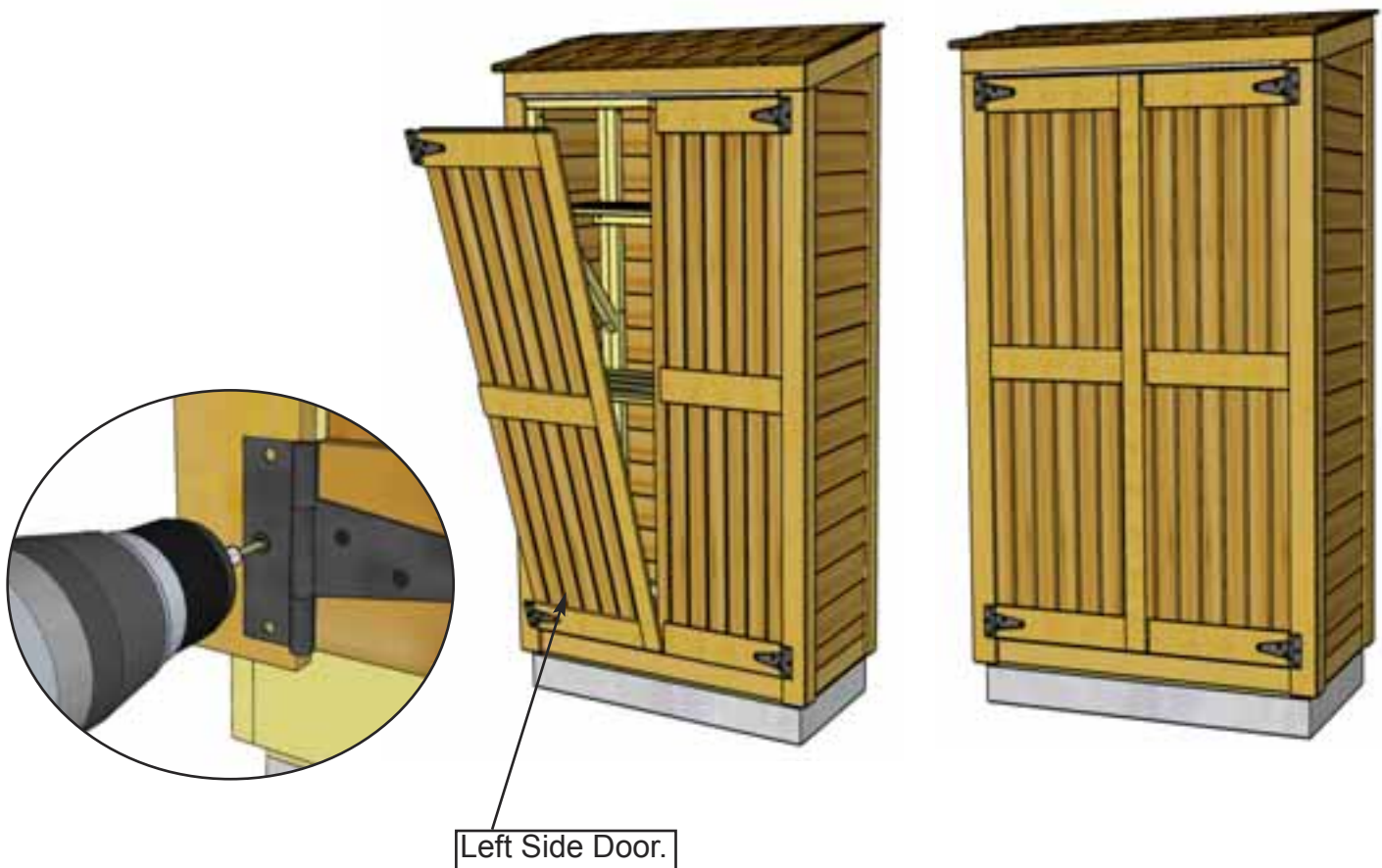

38. Position Left Side Door (with Flange) as per **Step 37**. Once again, use only 1 - 2" **Black Headed Screw** per Hinge initially to secure door to Low Wide Trim.

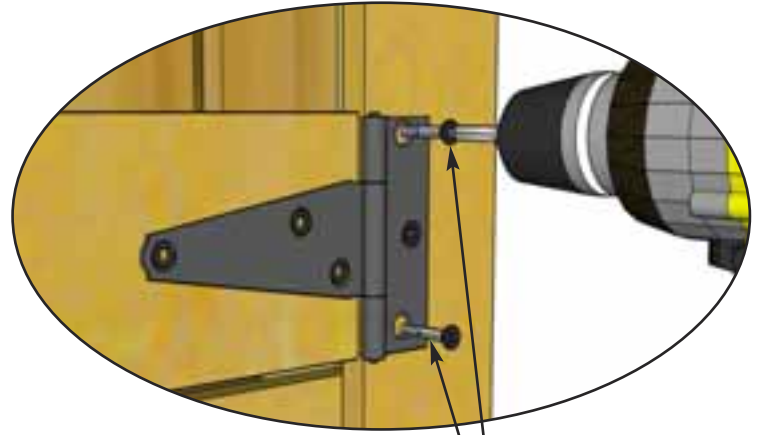

2 more - 2" Black Headed Screws per Hinge

39. With both Doors partially attached, check to see Doors open and close correctly. Make any necessary adjustments and when satisfied, completely secure Hinges to Low Wide Trims with **two more 2" Black Headed Screws** per Hinge. Drill pilot holes to prevent wood from splitting.



40. Attach **Door Handles** to Doors with **4 - 3/4" Black Headed Screws** per Handle. Choose desired Handle height.

Hardware
Black Handle x 2 total
3/4" Black Headed Screws x 8 total

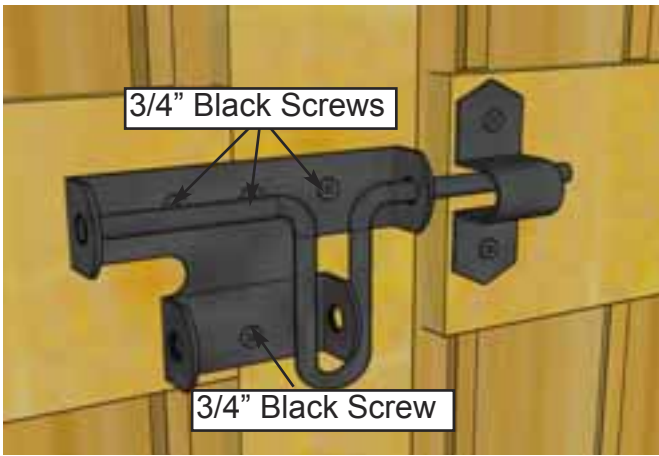

Important: Drill shallow Pilot Holes to prevent splitting.

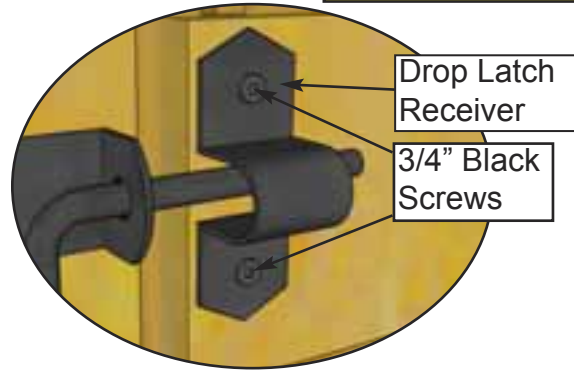

41. Attach **Black Drop Latch** as illustrated above with **6 - 3/4" Black Headed Screws**. **Note:** Black Drop Latch receiver is positioned higher than male. Do a dry run first to position Black Drop Latch correctly. **Important** - Drill pilot holes with 1/8" drill bit prior to securing with screws to prevent wood splitting.

Hardware
Black Drop Latch
3/4" Black Headed Screw x 6 total



42. Install the **Plywood Spacer** to interior door frame approximately 1 1/2" from top of door frame and 1" from edge, as pictured. Use **2 - 1 1/4" Brown Screws** to secure. Plywood Spacer should fit flush underneath Door Header when Door is closed.

Hardware
Plywood Spacer (1/2" x 2 1/2" x 2 1/2")
1 1/4" Brown Screws x 2 total



43. Position the **Interior Barrel Bolt** on the Plywood Spacer and attach with **4 - 3/4" Silver Screws**. Tap Barrel Bolt with hammer on underside of Door Header to mark location.

Hardware
Interior Barrel Bolt
3/4" Silver Screws x 4 total

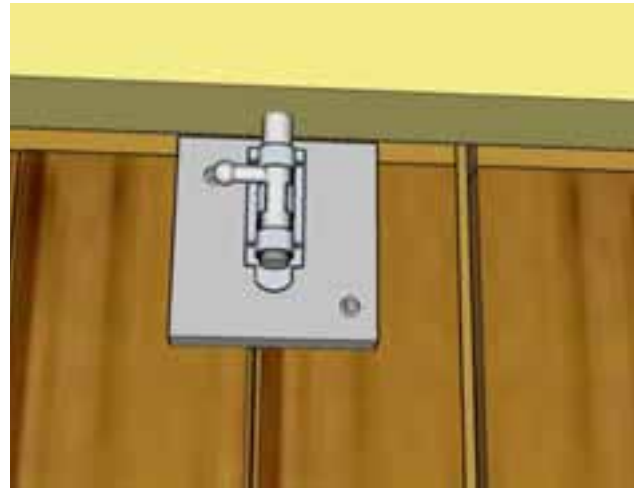

44. Open Door and drill out marked Barrel Bolt impression with a 3/8" Drill Bit. Close Door, slide Interior Barrel Bolt in drilled hole to confirm fit.



45. Using a Step Ladder, place **Roof Ridge Cap** on front row of Roof Shingles. Attach Ridge Cap with 4 - 1 1/2" Finishing Nails.

<p><u>Parts</u> Roof Ridge Cap (1/2" x 3 1/2" x 46")</p>	<p><u>Hardware</u> 1 1/2" Finishing Nails x 4 total</p>
---	--

A. Floor Section

Exploded view of all parts necessary to complete the Wall Section. Identify all parts prior to starting.

Floor Section

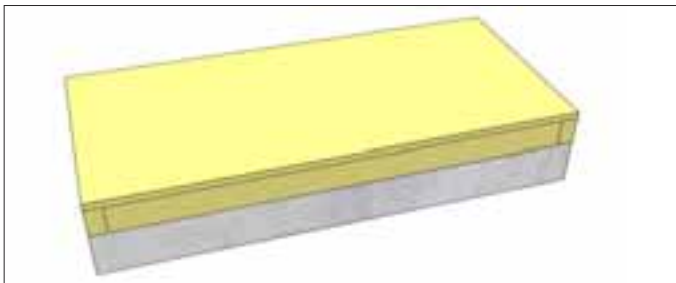
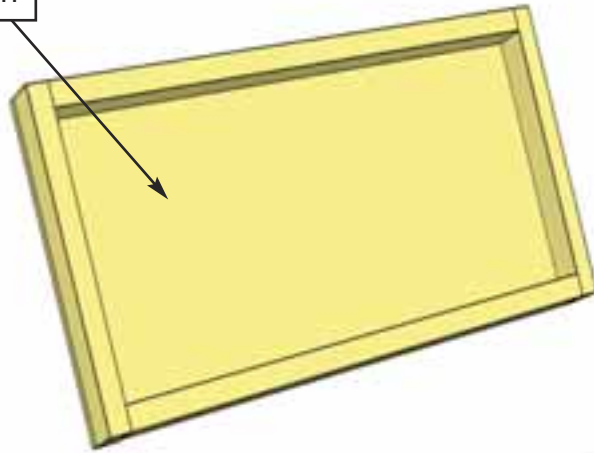

1. Locate **Floor Section** and flip over and lay on a level foundation only. Patio Stones or a Concrete Slab both make excellent foundations. (See Page 3 for more information on foundations). Use a level to confirm and shim Floor frame as required.

Parts
Floor Section
(19 1/2" x 42 1/8") x 1

B. Wall Section

Exploded view of all parts necessary to complete the Wall Section. Identify all parts prior to starting.

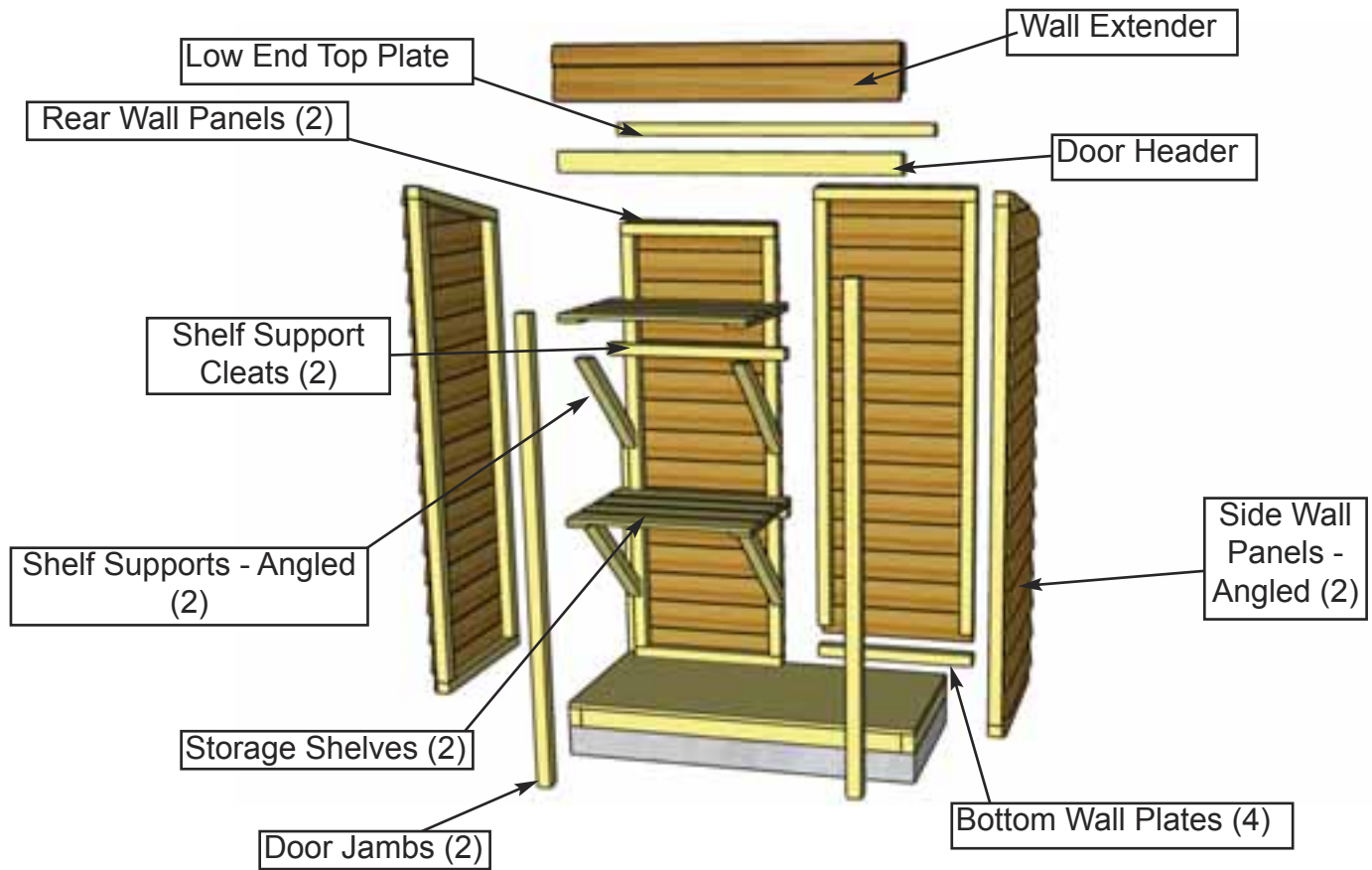

Due to packaging constraints, bottom wall plates must be attached prior to erecting walls.

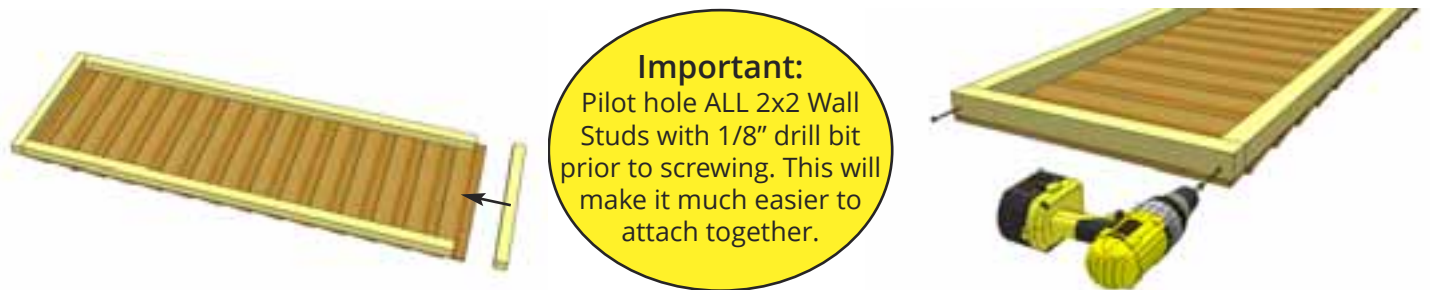

2. For each **Wall Panel**, carefully lay panel face down. Position and attach a **Bottom Wall Plate** to bottom of wall studs of each Wall Panel with **2 - 2 1/2" Brown Screws**. Position so Plates are flush with framing.

Parts	Hardware
Side Wall Panels - Angled (19 1/2" x 67") x 2	2 1/2" Brown Screws x 8 total
Rear Wall Panels (19 1/2" x 61 3/8") x 2	
Bottom Wall Plates (1 1/2" x 1 1/2" x 19 1/2") x 4	

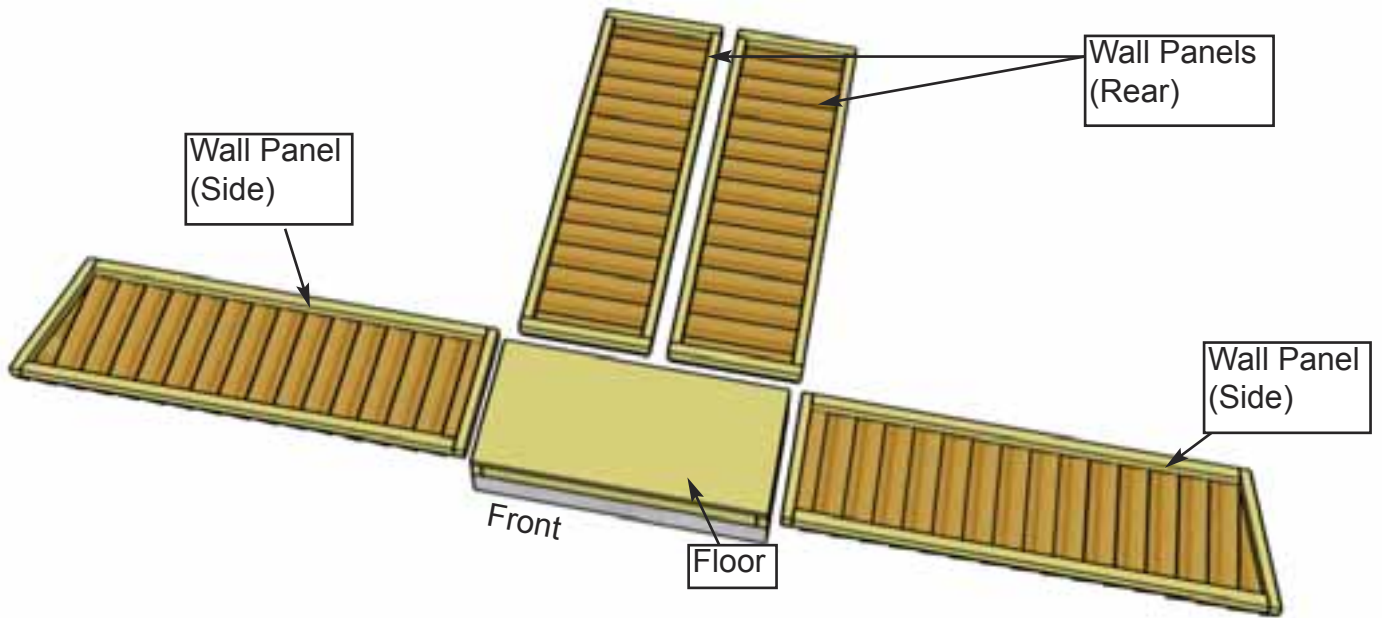

3. With Wall Plates properly attached, orientate completed Walls around the Floor. Be sure to leave room to work.

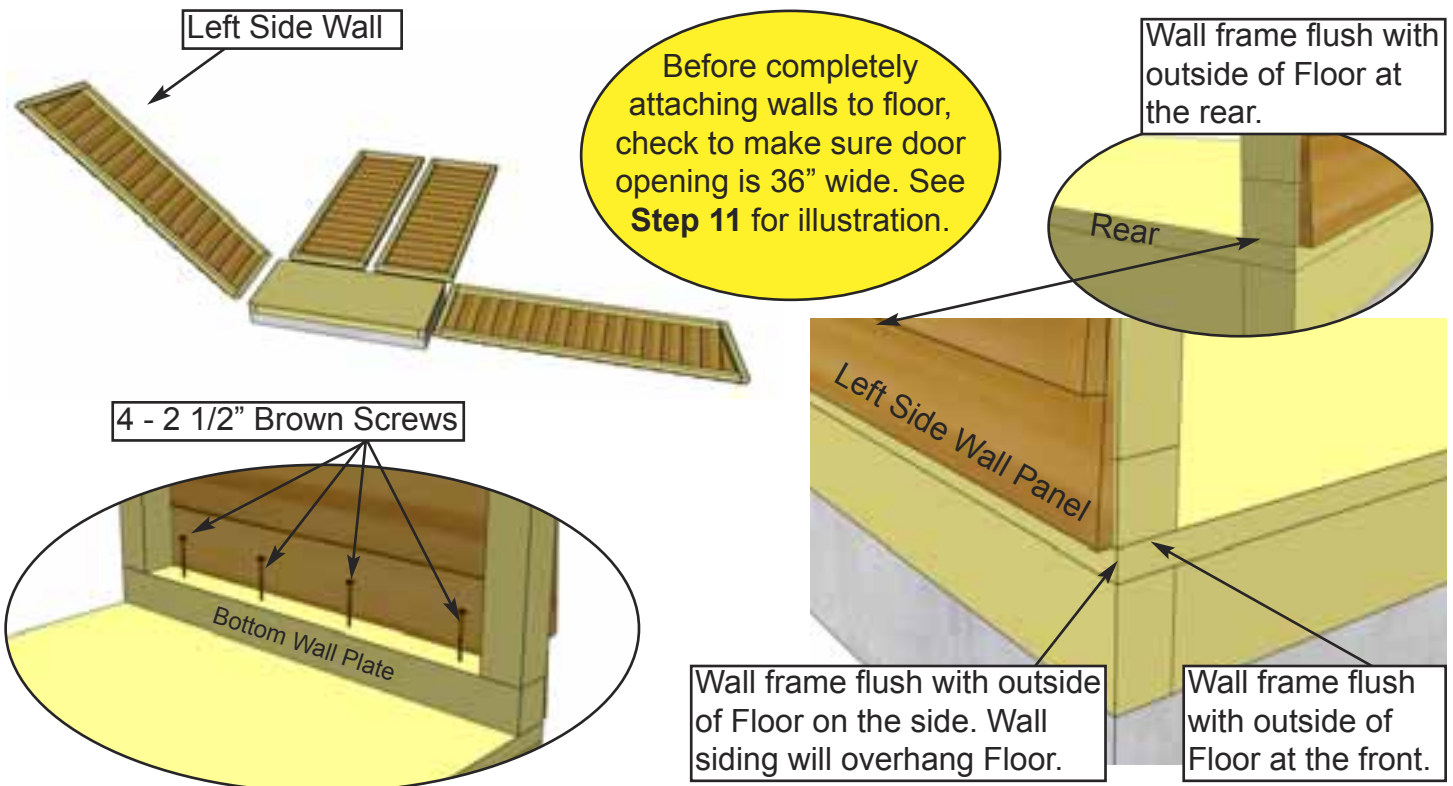

4. Starting with **Left Side Wall**, lift up and position so framing is flush with Floor at both front and rear of shed. Make sure the frame of the wall is inset 1 1/16" inside the floor. When Wall is positioned correctly, secure Bottom Wall Plate to Floor with **4 - 2 1/2" Brown Screws**.

Hardware (Steps 4 - 8)
2 1/2" Brown Screws
 x 13 total

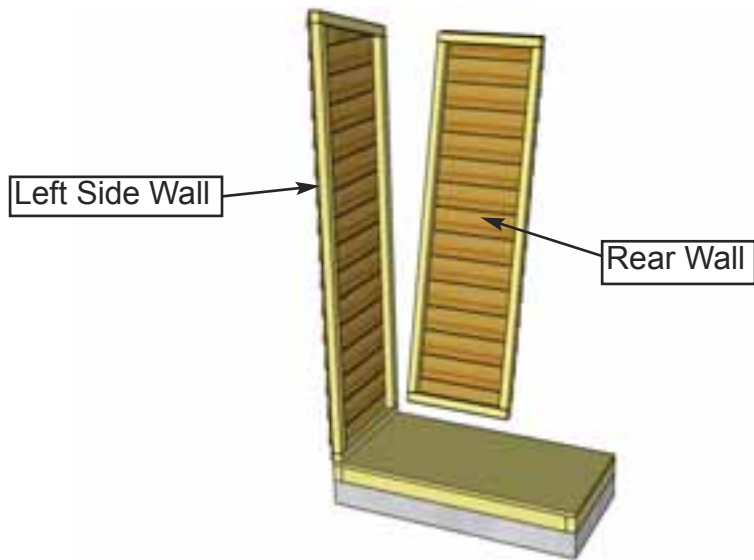

5. With your helper holding the Side Wall Panel, position a **Rear Wall Panel** in rear corner. **Important: Align Wall Framing Flush with Floor Framing.**

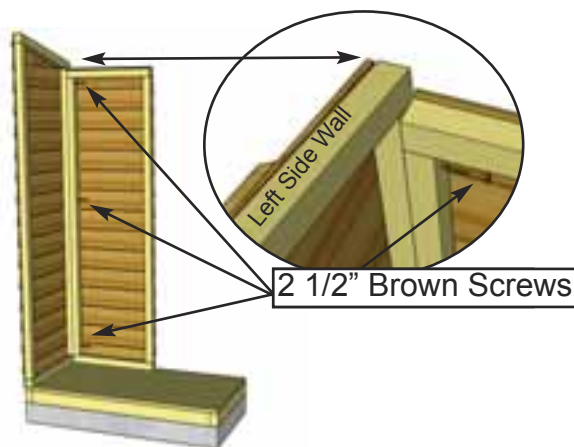
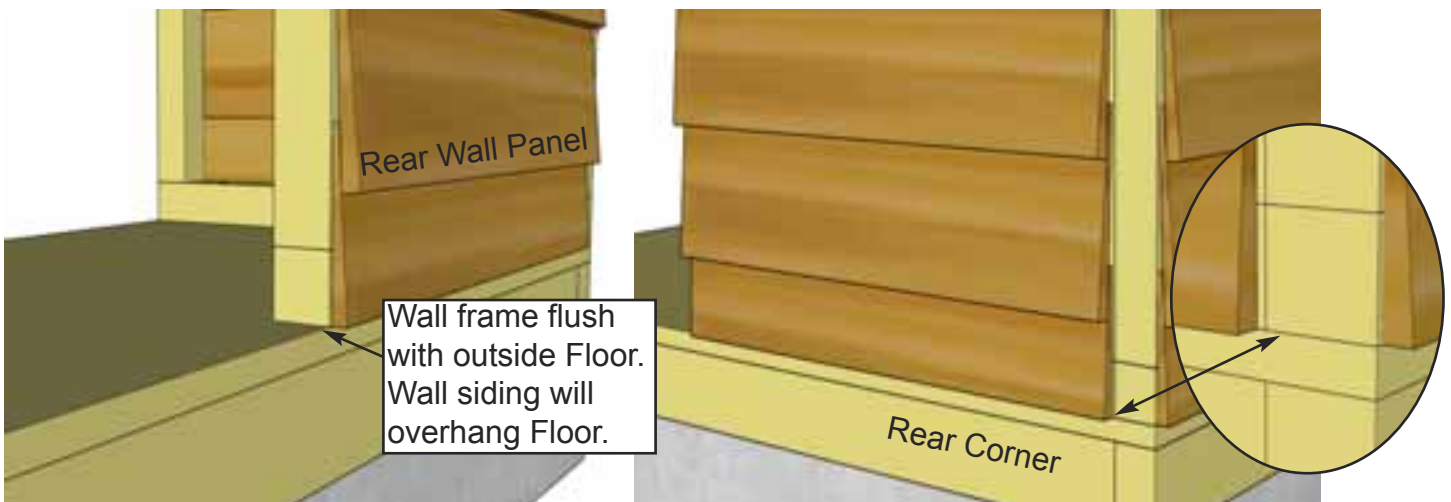

6. When Side and Rear Walls are aligned in corner correctly, Wall Framing will be flush. Attach Wall framings together with 3 - 2 1/2" Brown Screws.



7. Position second **Rear Wall Panel** on Floor as per **Step 6**. Attach Wall frames together at top, middle and bottom with 3 - **2 1/2" Brown Screws**. A wood clamp will be helpful in holding pieces together while fastening. **Important: Confirm Siding on Rear Wall Panels are aligned.**

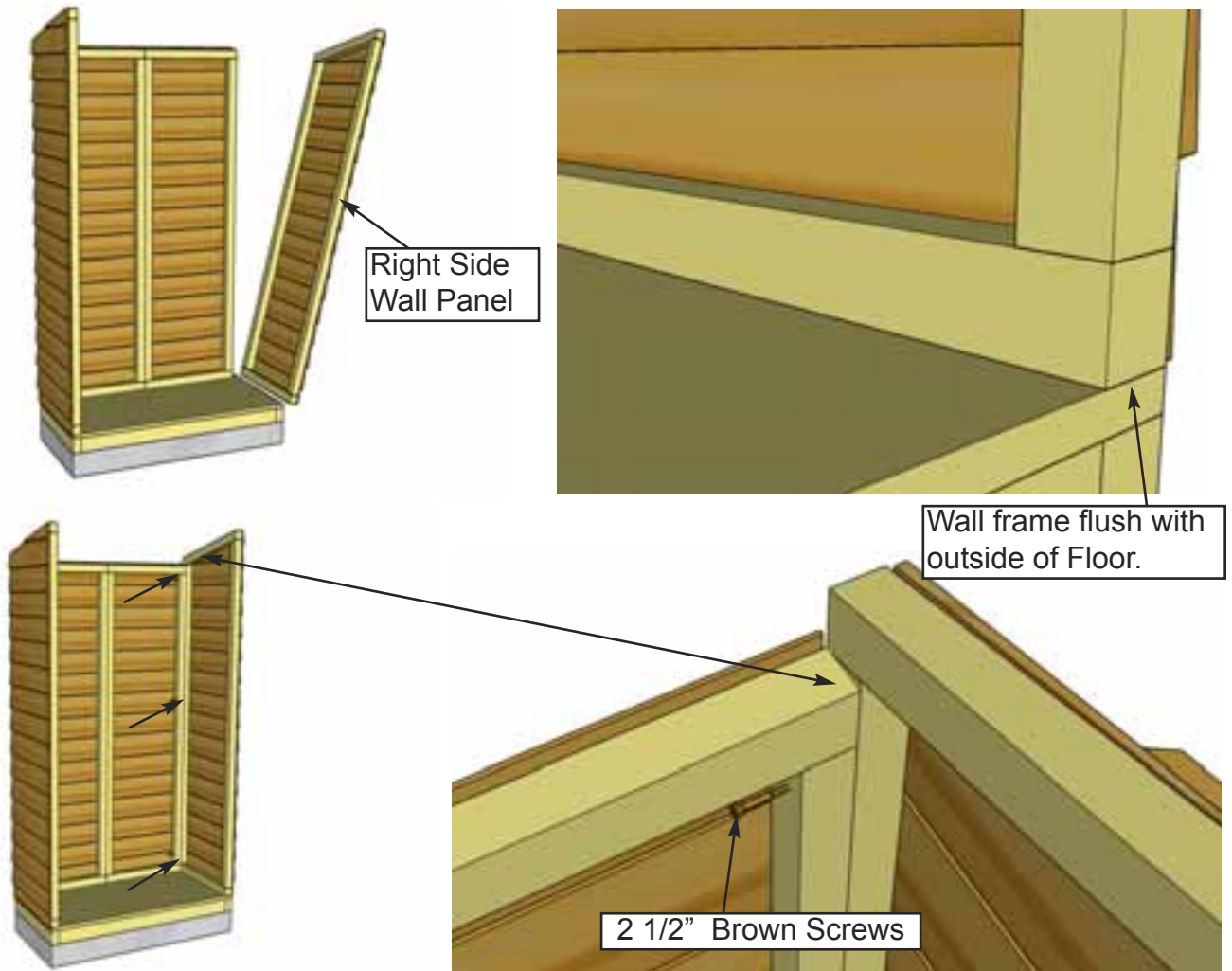

8. In the corner, align and attach Right Side Wall framing to Rear Wall framing with 3 - **2 1/2" Brown Screws** as per **Step 6**.

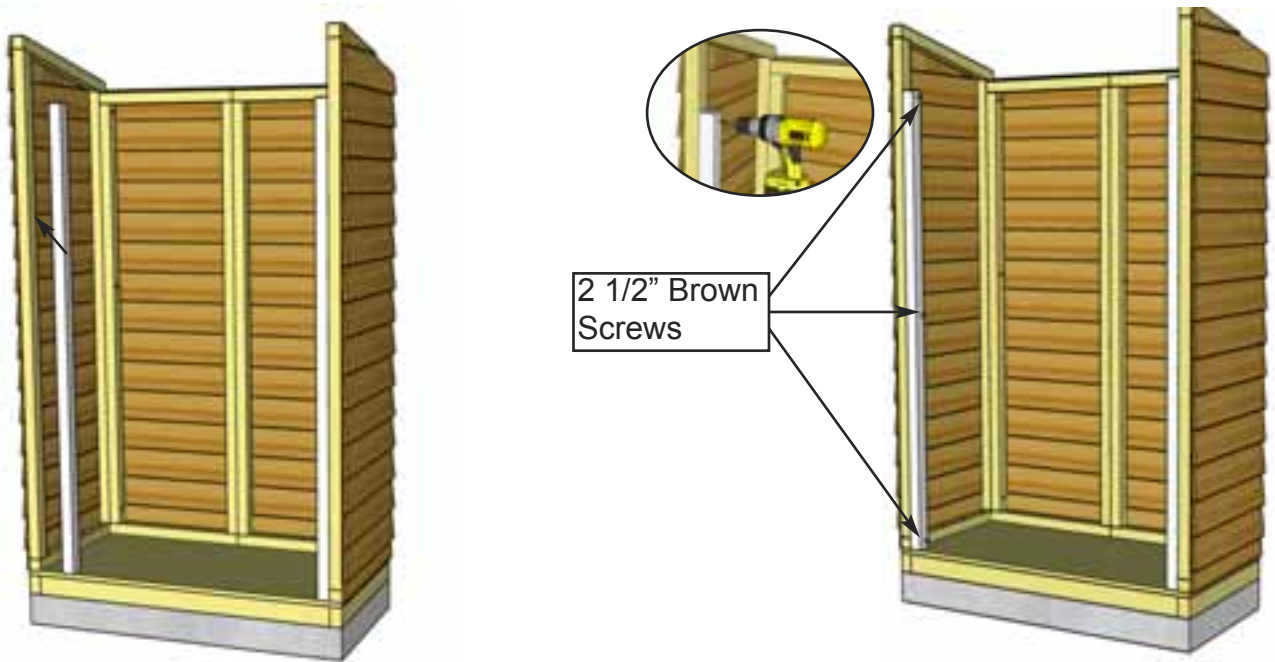

9. Locate both **Door Jambs**. Position each Door Jamb tight to Side Wall framing and flush with the floor. Screw each Door Jamb into wall framing with 3 - 2 1/2" Brown Screws per piece.

<u>Parts</u> Door Jambs (1 1/2" x 1 1/2" x 58 7/8") x 2	<u>Hardware</u> 2 1/2" Brown Screws x 6 total
--	--

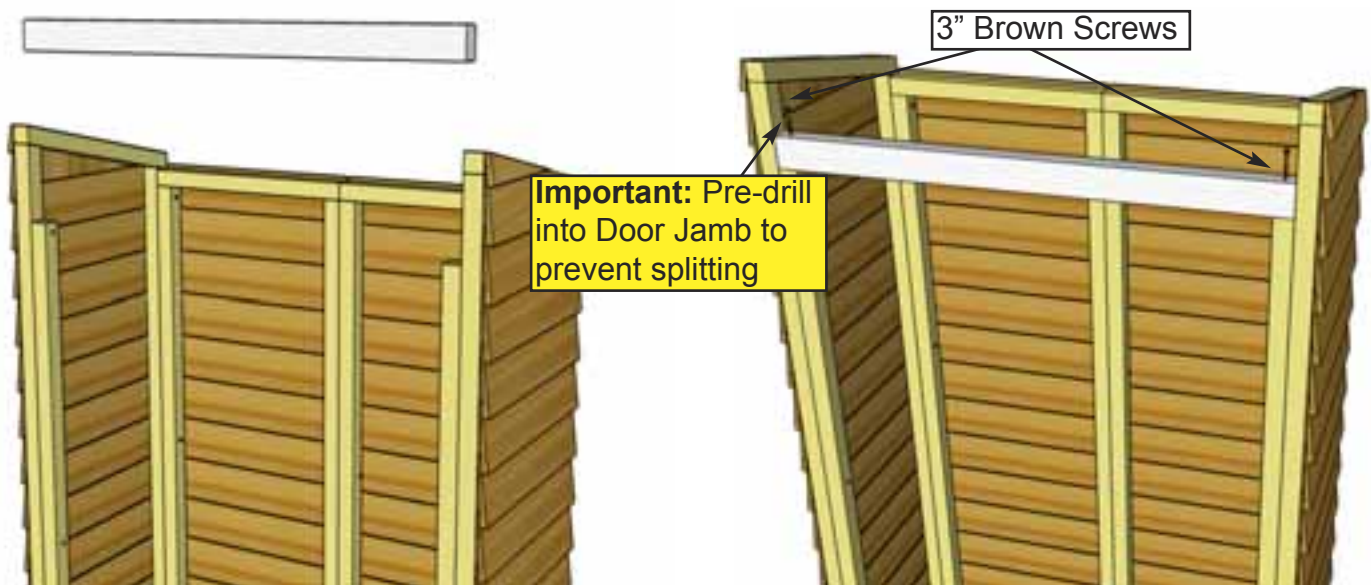

10. Locate **Door Header** and position on top of previously installed Door Jambs. Pilot hole into the Door Jamb with a 1/8" bit to prevent splitting. Secure Door Header to Door Jambs with 2 - 3" Brown Screws.

<u>Parts</u> Door Header (1 1/2" x 2 1/2" x 39")	<u>Hardware</u> 3" Brown Screws x 2 total
---	--

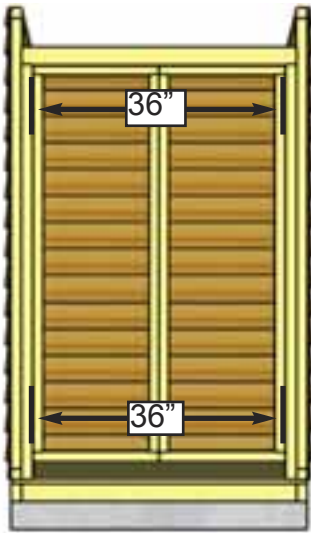

11. With Door Header installed, confirm Door width at both the top and bottom of the doorway. Doorway opening should be 36" wide. If required, loosen screws in Side Walls, adjust Door width and re-secure. There can be a 1/8" tolerance in the width but both top and bottom should match.

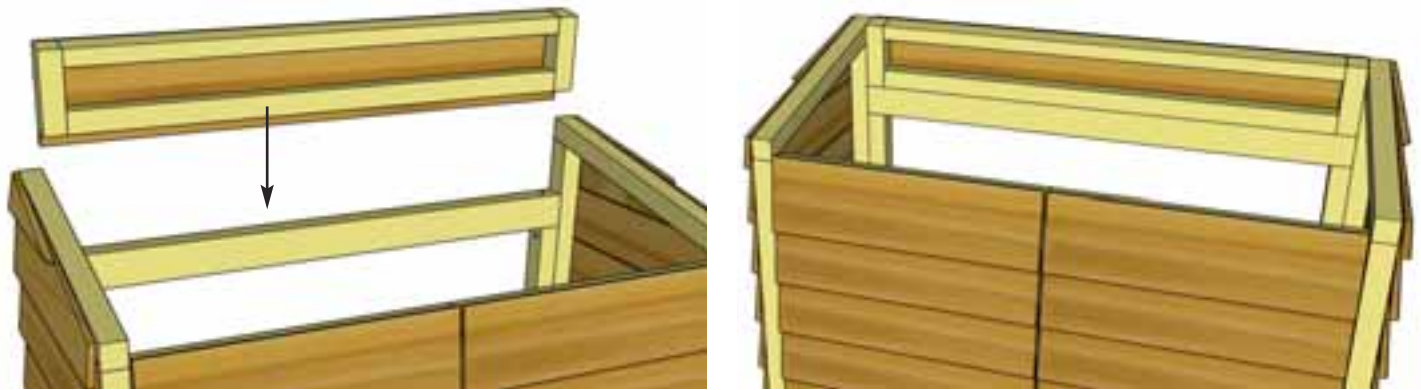

12. Position **Wall Extender** on top of Door Header and in between Angled Side Wall Panels.

<p>Parts (Step 12 - 13) Wall Extender (6 5/8" x 39")</p>	<p>Hardware (Steps 12 - 13) 2 1/2" Brown Screws x 4 total</p>
---	--

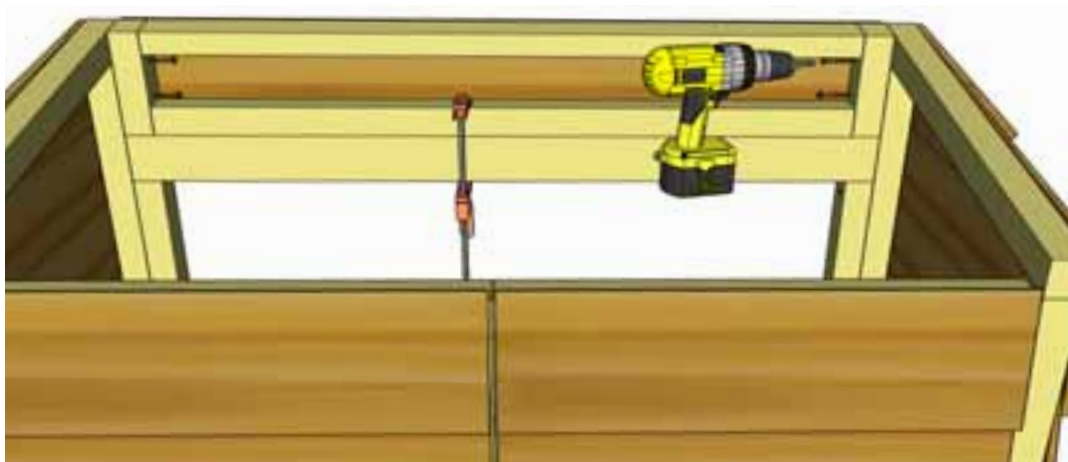

13. Fasten 2 - 2 1/2" Brown Screws through the side into the Angled Side Wall. Repeat for both sides of shed, fastening to Angled Side Walls. A wood clamp will be helpful in holding pieces together while fastening. Note: If you have room to do so, angle the bottom 2 1/2" Brown Screws down through Wall Extender into Door Header instead of through the side into Angled Side Wall.

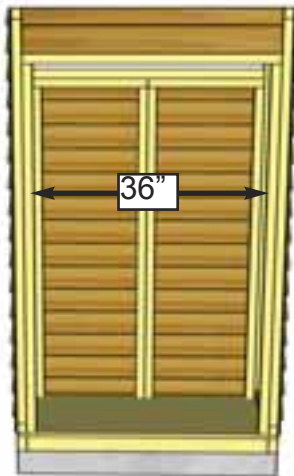
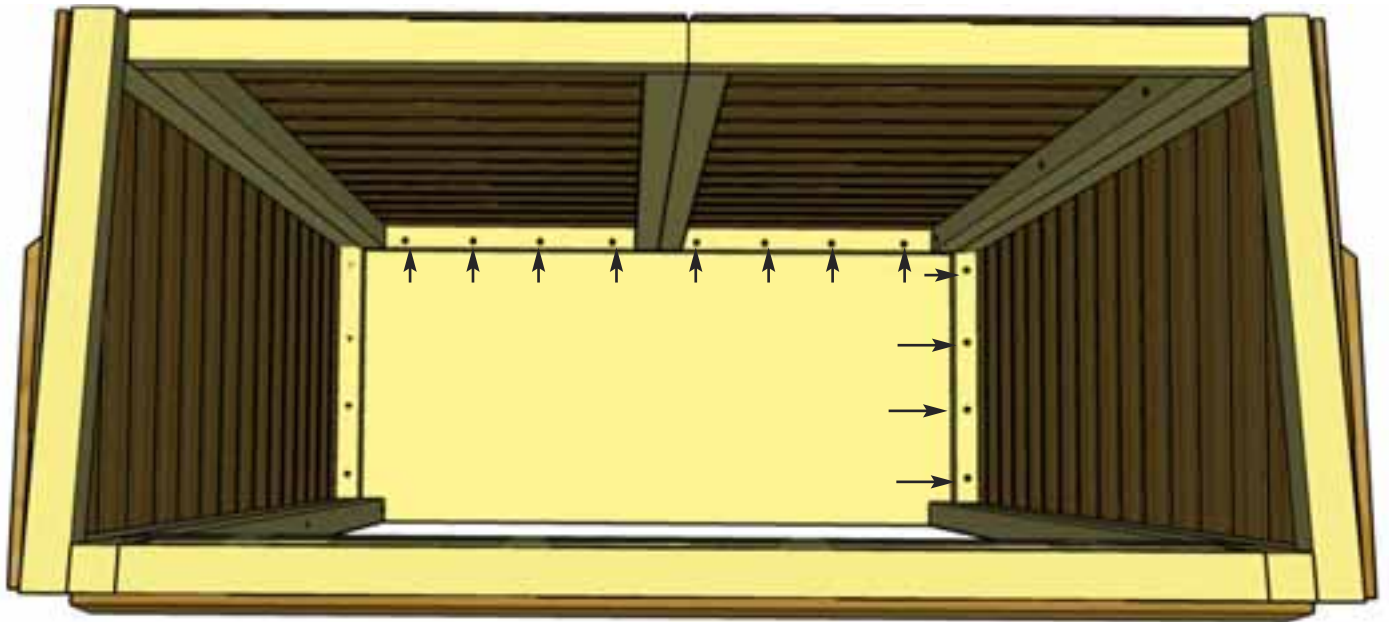

14. With Walls secured, confirm again that the doorway opening is 36". Check interior corner to corner measurements are 42 3/8" across diagonally. With doorway measurement confirmed, begin to fasten Wall Panels down to Floor with 2 1/2" **Brown Screws**. Use 4 - 2 1/2" **Brown Screws** per Wall Panel. Screw through Bottom Wall Plate into Floor. Note: Left Side Wall has already been fastened down in **Step 4**.

Hardware
 2 1/2" **Brown Screws**
 x 12 total

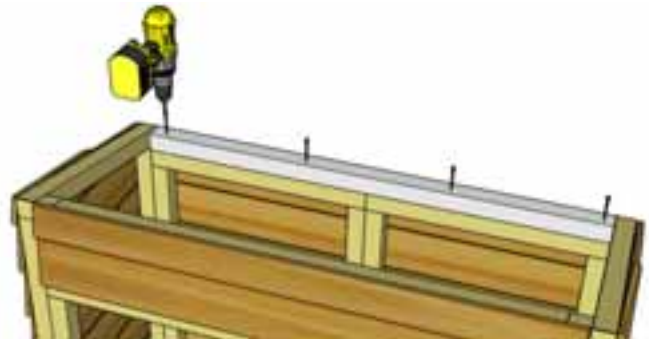

15. Locate **Low End Top Plate** and position on top of Rear Wall. Secure Low End Top Plate to Rear Wall with 4 - 2 1/2" Brown Screws.

<u>Parts</u> Low End Top Plate (1 1/2" x 1 1/2" x 39")	<u>Hardware</u> 2 1/2" Brown Screws x 4 total
---	--



16. Locate **Shelf Support Cleats**. Each Shelf requires one Support Cleat and these will set the height of your Shelves. We recommend 25 1/4" from the Floor for the first one and 45 1/2" from the Floor for the second. These can be adjusted as you wish but leave 18 3/4" of space between the Cleats. Attach Shelf Support Cleats to Rear Wall with 2 - 2 1/2" Brown Screws per Cleat.

<u>Parts</u> Shelf Support Cleats (1 1/2" x 1 1/2" x 22 1/2") x 2	<u>Hardware</u> 2 1/2" Brown Screws x 4 total
--	--

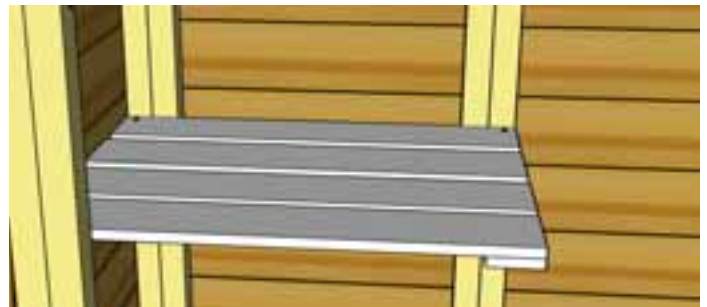

17. Place one **Shelf** on top of Shelf Support Cleat. Have a helper hold the shelf in place while you attach it. Drill 2 - 2" Brown Screws through Shelf into Shelf Support Cleat.

<u>Parts</u> Shelf (16 3/8" x 22 1/2")	<u>Hardware</u> 2" Brown Screws x 2 total
---	--



18. Place two **Shelf Supports** underneath Shelf. Drill 2 - **2" Brown Screws** through Shelf Support into underside of Shelf at the top and through Shelf Support into Rear Wall Framing at the bottom.

<u>Parts</u> Shelf Supports - Angled (1 1/2" x 1 1/2" x 20 1/2") x 2	<u>Hardware</u> 2" Brown Screws x 4 total
---	--



19. Attach second **Shelf** as per **Steps 17-18**. Have a helper hold the shelf in place while you attach it.

<u>Parts</u> Shelf (16 3/8" x 22 1/2") Shelf Supports - Angled (1 1/2" x 1 1/2" x 20 1/2") x 2	<u>Hardware</u> 2" Brown Screws x 6 total
--	--

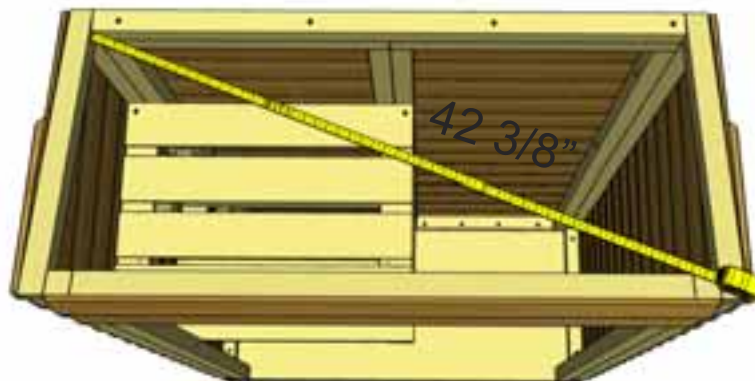

Before Roof Section, once again take a diagonal measurement in both directions and square up the shed. If diagonal measurement is more than 1/8" different between sides, try pushing corner of shed in or out.

C. Roof Section

Exploded view of all parts necessary to complete the Roof Section. Identify all parts prior to starting.

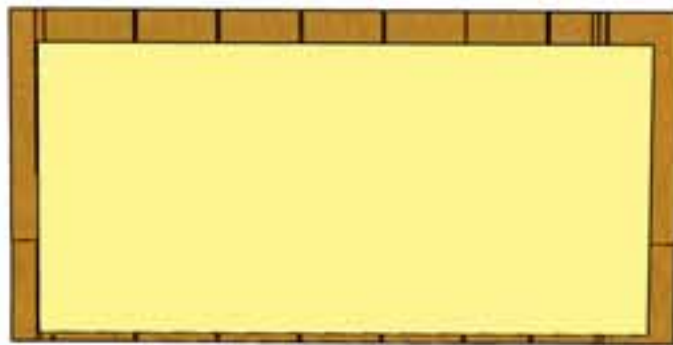

Cedar Shingle Roof Panel

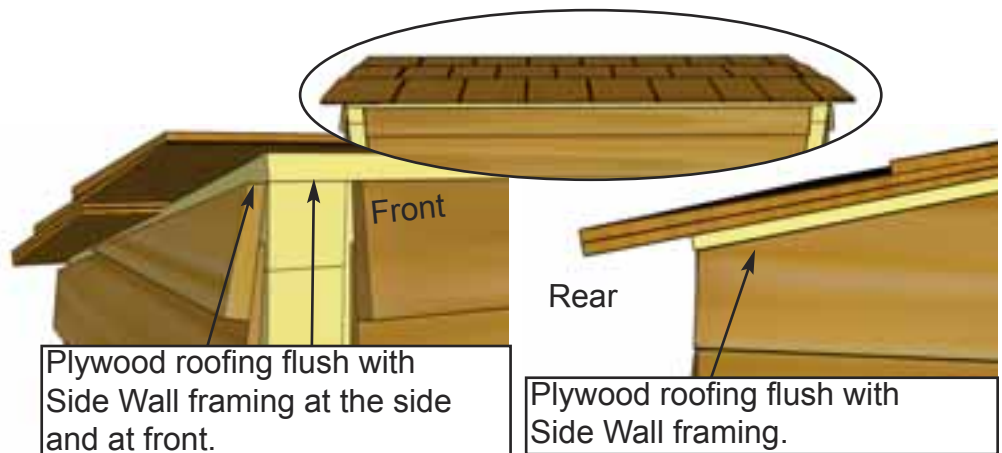

20. Lift up Cedar Shingle Roof Panel and place on upper wall framing. At the front, align plywood roofing flush with Side Wall framing at the side and at the front. At the rear, align plywood roofing flush with Side Wall framing.

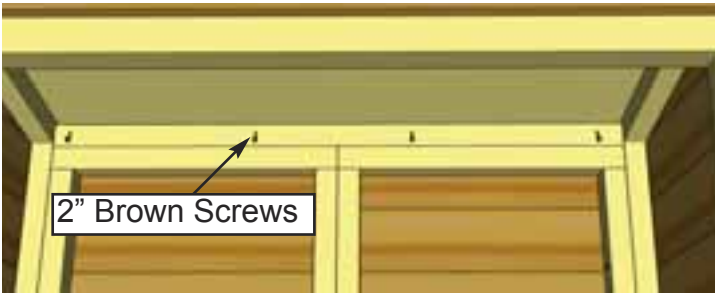

2" Brown Screws

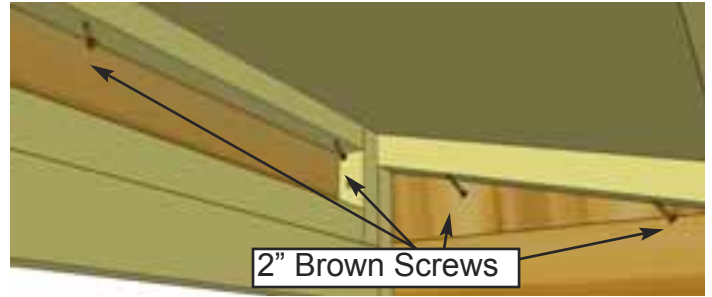

2" Brown Screws

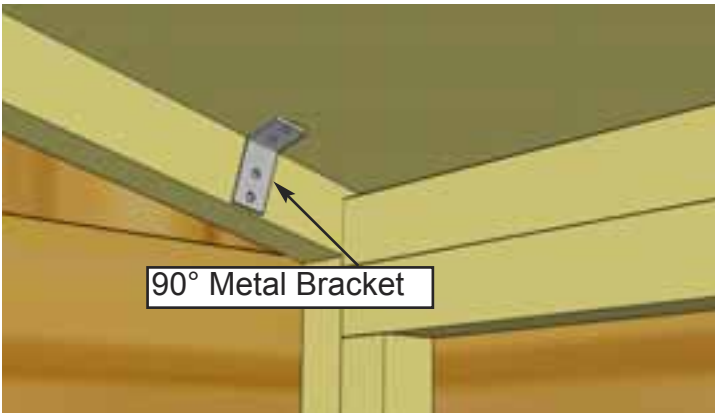

90° Metal Bracket

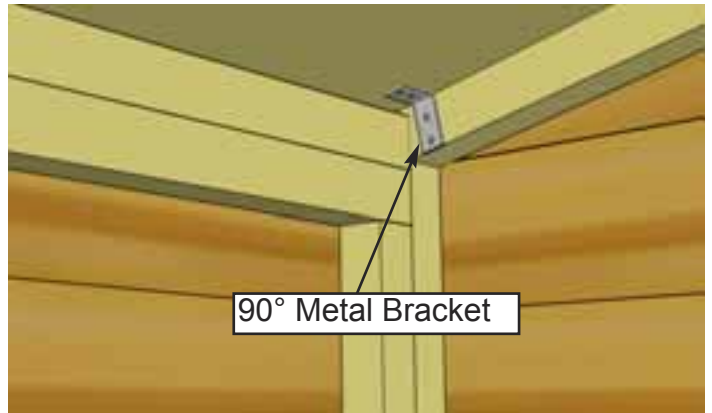

90° Metal Bracket

21. From inside the shed, start securing the Roof by screwing through Low End Top Plate into Roof Panel on an angle with 4 - **2" Brown Screws**. Make sure screw tips do not go completely through Roof Panel. At the sides, screw from upper framing into Roof Panel. Use 2 - **2" Brown Screws** per Side Angled Wall. Screw on an angle and make sure screw tips do not go completely through Roof Panel. At the rear, secure the Roof by attaching the Wall Extender to Roof Panel on an angle with 4 - **2 1/2" Brown Screws**. Further secure Roof Panel to Walls at sides by positioning 2 - **90° Metal Brackets** onto Roof Plywood and Side Angled Walls where Side Angled Wall meets front Wall. Secure with 4 - **3/4" Silver Screws** per bracket.

<u>Parts</u>	<u>Hardware</u>
Cedar Shingle Roof Panel (23" x 46")	2" Brown Screws x 12 total 90° Metal Brackets x 2 total 3/4" Silver Screws x 8 total



22. Check the Wall seams for visible gaps prior to attaching Filler Trim and apply caulk where needed. Caulking gaps will help prevent moisture from entering and will help the longevity of your shed. **Caulking not included in kit.**

E. Miscellaneous Section

Exploded view of all parts necessary to complete the Skirting, Trim, Fascia and Miscellaneous Pieces. Identify all parts prior to starting.

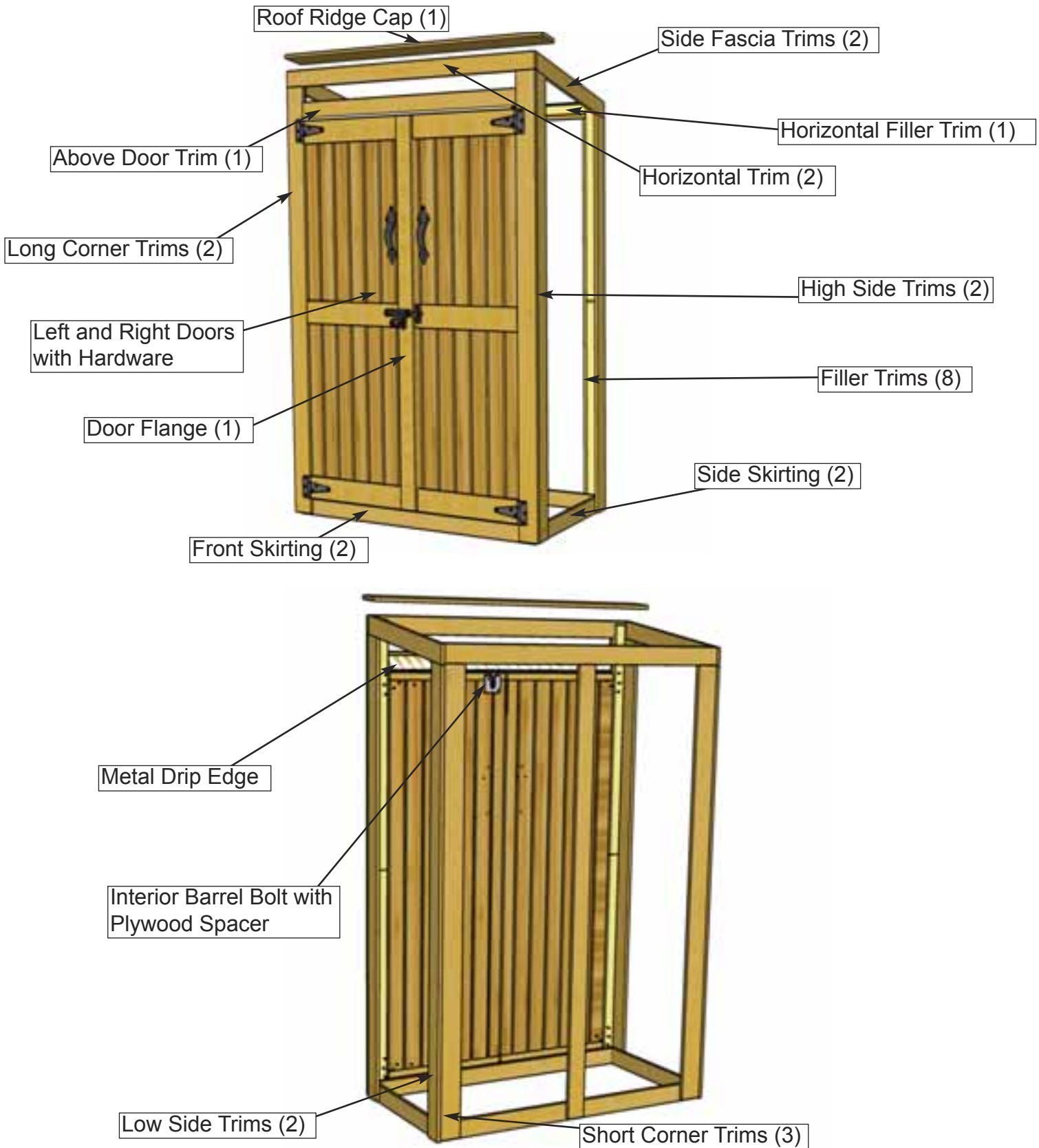

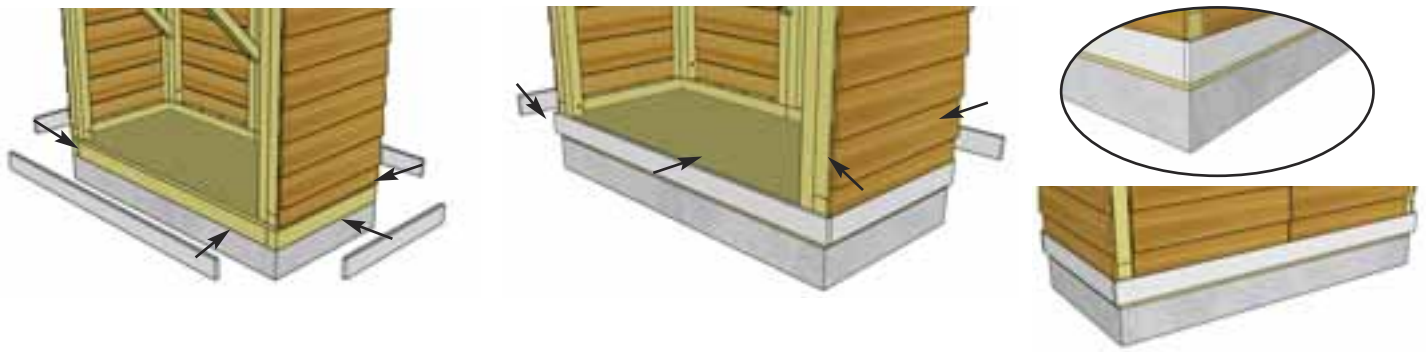

23. Locate **Front/Rear Skirting**. Skirting will hide Floor framing and gaps will be covered by Wide Trim pieces later. Attach Front/Rear Skirting pieces with **6 - 1 1/2" Finishing Nails** per piece. Locate **Side Skirting** and attach with **4 - 1 1/2" Finishing Nails** per piece.

<p><u>Parts</u> Front/Rear Skirting (1/2" x 2 1/2" x 43") x 2 Side Skirting (1/2" x 2 1/2" x 19 1/2") x 2</p>	<p><u>Hardware</u> 1 1/2" Finishing Nails x 20 total</p>
---	---



24. Locate **Horizontal Filler Trims**. Position first Horizontal Filler Trim on Low End Top Plate. Evenly space from side to side. Secure with **6 - 1 1/2" Finishing Nails** into Low End Top Plate.

<p><u>Parts (Steps 24 - 25)</u> Horizontal Filler Trim (7/8" x 1 1/2" x 39") x 2</p>	<p><u>Hardware (Steps 24 - 25)</u> 1 1/2" Finishing Nails x 12 total</p>
---	---



25. Locate **4 Filler Trims**. Filler trim will be covered by Corner Trim in **Step 32**. Attach in each corner with **3 - 1 1/2" Finishing Nails** per piece.

<p><u>Parts (Step 26 - 27)</u> Filler Trims (7/8" x 1 1/2" x 31 3/8") x 8</p>	<p><u>Hardware (Step 26 - 27)</u> 1 1/2" Finishing Nails x 24 total</p>
--	--

Place High Side Filler Trim at the top



26. Position and attach 2 more Filler Trims and High Side Filler Trims at the front as per Step 25. Note: High Side Filler Trims will have a gap in between when installed, this will be covered with trim in Step 32.

Expert Advice:

Do a dry run with Front/Rear Horizontal and Side Fascia Trims before attaching. Confirm the rough face is configured correctly and small trim gaps are satisfactory before attaching.

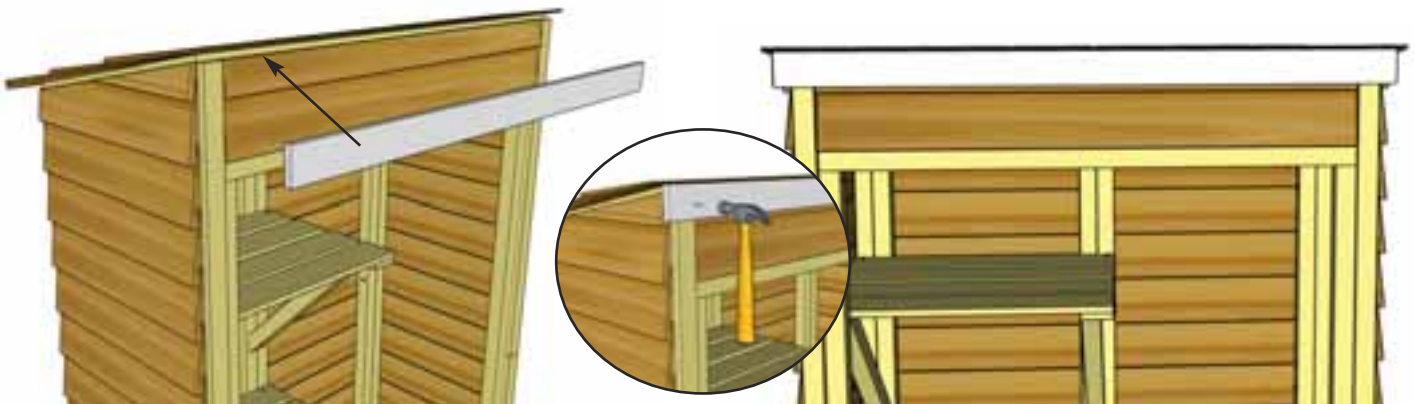

27. Locate Front Horizontal Trim. Position onto Wall Extender and underneath Cedar Roof. Evenly space from side to side and secure with 6 - 1 1/2" Finishing Nails.

Parts
Horizontal Trim
(1/2" x 2 1/2" x 45")

Hardware
1 1/2" Finishing Nails
x 6 total



28. Locate **Side Fascia Trim**. Position Side Fascia underneath Cedar Roof and attach to Angled Wall Panel with 4 - 1 1/2" Finishing Nails.

<u>Parts</u> Side Fascia Trim (Angle Cut Both Ends) (1/2" x 2 1/2" x 22 3/4")	<u>Hardware</u> 1 1/2" Finishing Nails x 4 total
--	---



29. Attach second **Side Fascia** and **Horizontal Trim** as per Steps 27 - 28.

<u>Parts</u> Side Fascia Trim (Angle Cut Both Ends) (1/2" x 2 1/2" x 22 1/8") Horizontal Trim (1/2" x 2 1/2" x 45")	<u>Hardware</u> 1 1/2" Finishing Nails x 6 total
---	---

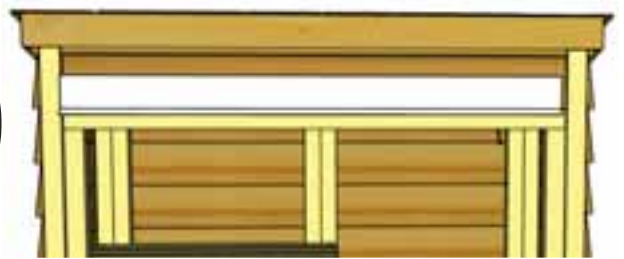
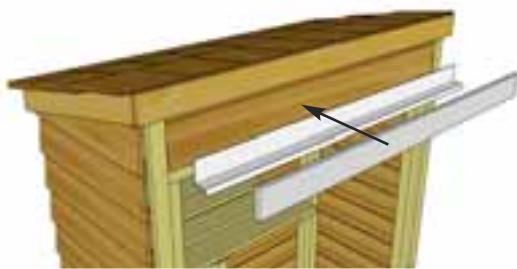

30. Locate **Metal Drip Edge** and **Above Door Trim**. Position Metal Drip Edge onto Wall Extender and between High Side Filler Trim. Have a helper hold down Metal Drip Edge and place Above Door Trim on top of Metal Drip Edge. Evenly space from side to side and secure with 6 - 1 1/2" Finishing Nails.

<u>Parts</u> Metal Drip Edge (38") Above Door Trim (1/2" x 2 1/2" x 39")	<u>Hardware</u> 1 1/2" Finishing Nails x 6 total
---	---

Expert Advice:

Do a dry run with trims before attaching. Confirm the rough face is configured correctly and small trim gaps are satisfactory before attaching.



31. Locate **High Wide Trim** and **High Side Trims**. Position first High Wide and High Side Trims underneath Front Horizontal Trim and Side Fascia. High Wide Trims will cap High Side Trims. Attach each piece with **6 - 1 1/2" Finishing Nails**.

Parts (Step 32 - 33)
Long Corner Trims
(1/2" x 3" x 68") x 2
High Side Trims (Angle Cut)
(1/2" x 2 1/2" x 67 3/8") x 2

Hardware (Step 32 - 33)
1 1/2" Finishing Nails
x 24 total

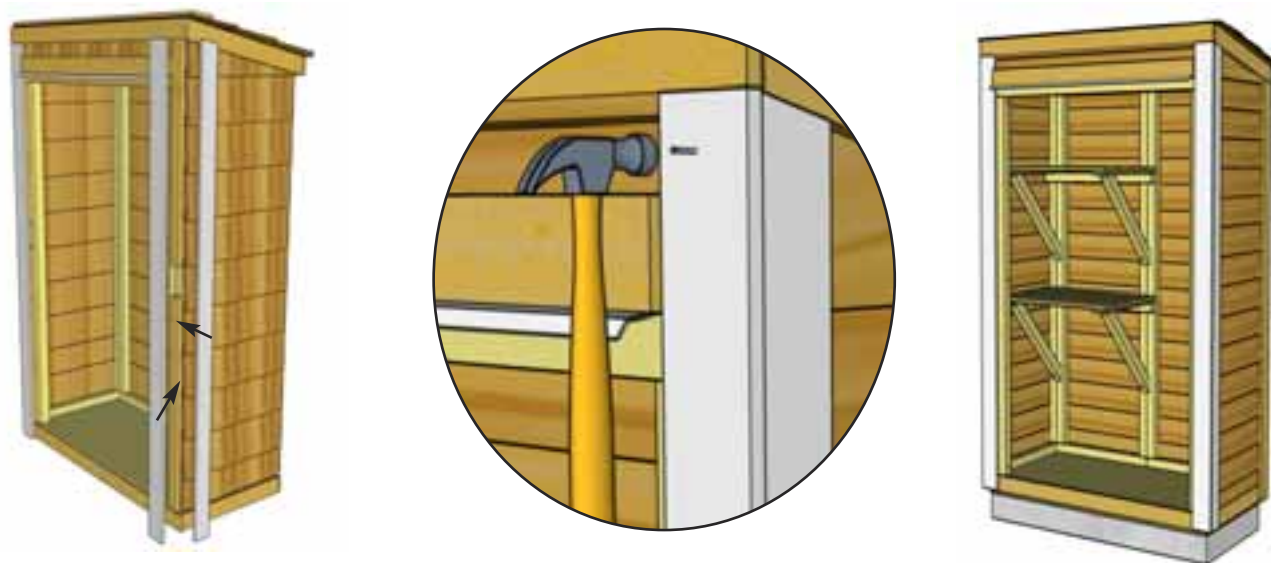

32. Attach second **Long Corner** and **High Side Trims** as per Step 31.



33. Locate **Low Wide Trims, Low Side Trims and Low Middle Trim.** Starting in one corner, position Low Wide and Low Side Trims up tight underneath Rear Horizontal Trim and Side Fascia Trim. Low Side Trim will cap Low Wide Trim. When correctly aligned, attach each piece with 6 - 1 1/2" Finishing Nails.

<p><u>Parts (Step 33 - 34)</u> Short Corner Trims (1/2" x 3" x 63 3/8") x 3 Low Side Trims (Angle Cut) (1/2" x 2 1/2" x 63 3/8") x 2</p>	<p><u>Hardware (Step 33 - 34)</u> 1 1/2" Finishing Nails x 30 total</p>
--	--



34. Place **Short Corner Trim** tight against the rear Horizontal Trim at the rear and attach with 6 - 1 1/2" Finishing Nails. Attach second **Short Corner Trim** and **Low Side Trim** as per Step 33.

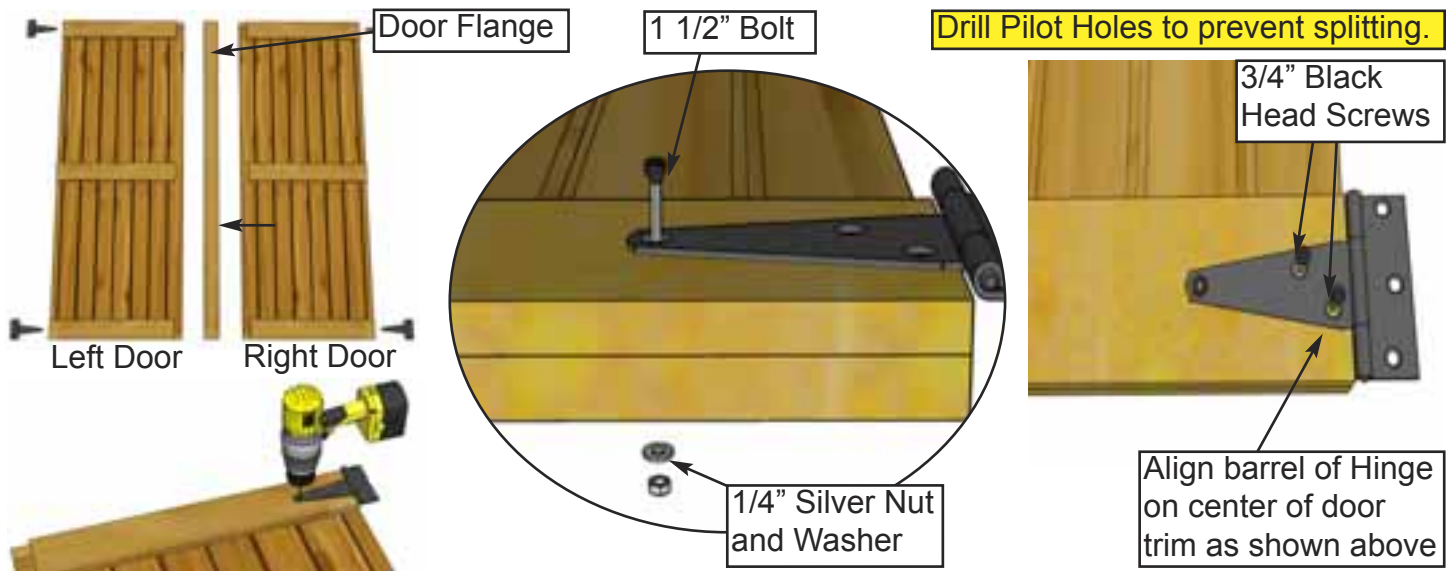

35. Locate **Left** and **Right Doors** and **Door Flange**. Orientate Doors so the outside of each Door is facing up. Locate **Black T Hinges**. Prior to attaching, position Hinges equally on Door trim as shown above and with a 1/8" drill bit, drill a hole through the tip of the Hinge and all the way through the Door. Complete for all 4 hinges. Attach each Hinge to Door as above with 1 - 1 1/2" **Black Headed Bolt**, and a 1/4" **Silver Nut and Washer**, using a 3/8" wrench. Finish Hinge by securing with 2 - 3/4" **Black Headed Screws**. Drill small pilot holes first to prevent wood from splitting. Complete both Doors (4 Hinges).

<p><u>Parts (Step 35 - 39)</u> Left and Right Doors (18 3/4" x 59 3/8") Door Flange (1/2" x 2 1/2" x 59 3/8")</p>	<p><u>Hardware (Step 35 - 39)</u> Black T Hinge x 4 total 1 1/2" Black Headed Bolt x 4 total 1/4" Silver Nut and Washer x 4 total 3/4" Black Headed Screws x 8 total 1" Silver Screws x 6 total 2" Black Headed Screws x 12 total</p>
---	---

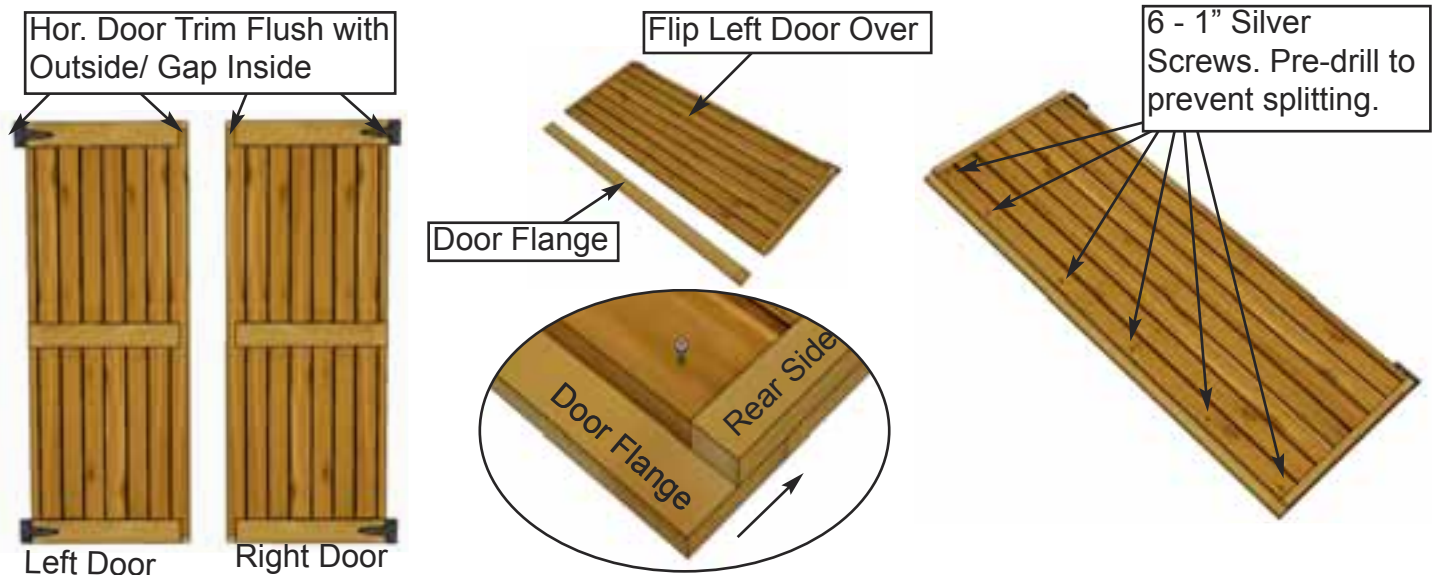

36. Flip Left Door over to attach **Door Flange**. Position Door Flange tight against horizontal trim and even with trim on top and bottom. If out slightly, make sure top horizontal trim and Flange are even. Pre-drill with 1/8" bit to prevent wood from splitting. Attach with 6 - 1" **Silver Screws**.

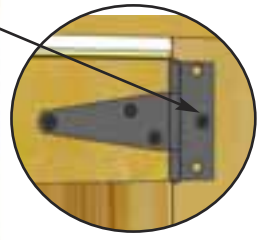
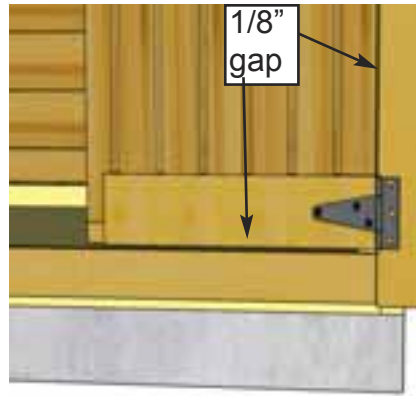

1 - 2" Screw per Hinge Initially.

37. Starting with Right Door first, lift and position Door in opening. Leave a 1/8" gap on right side and 1/8" gap on the bottom. Use a **Cedar Shingle Shim** to shim the Door at bottom to help position door evenly. When Door is aligned correctly, screw Hinge into Low Wide Trim with 1 - 2" **Black Headed Screws**. Use only 1 screw initially per Hinge until both Door alignments are confirmed. Drill pilot holes to prevent wood from splitting.

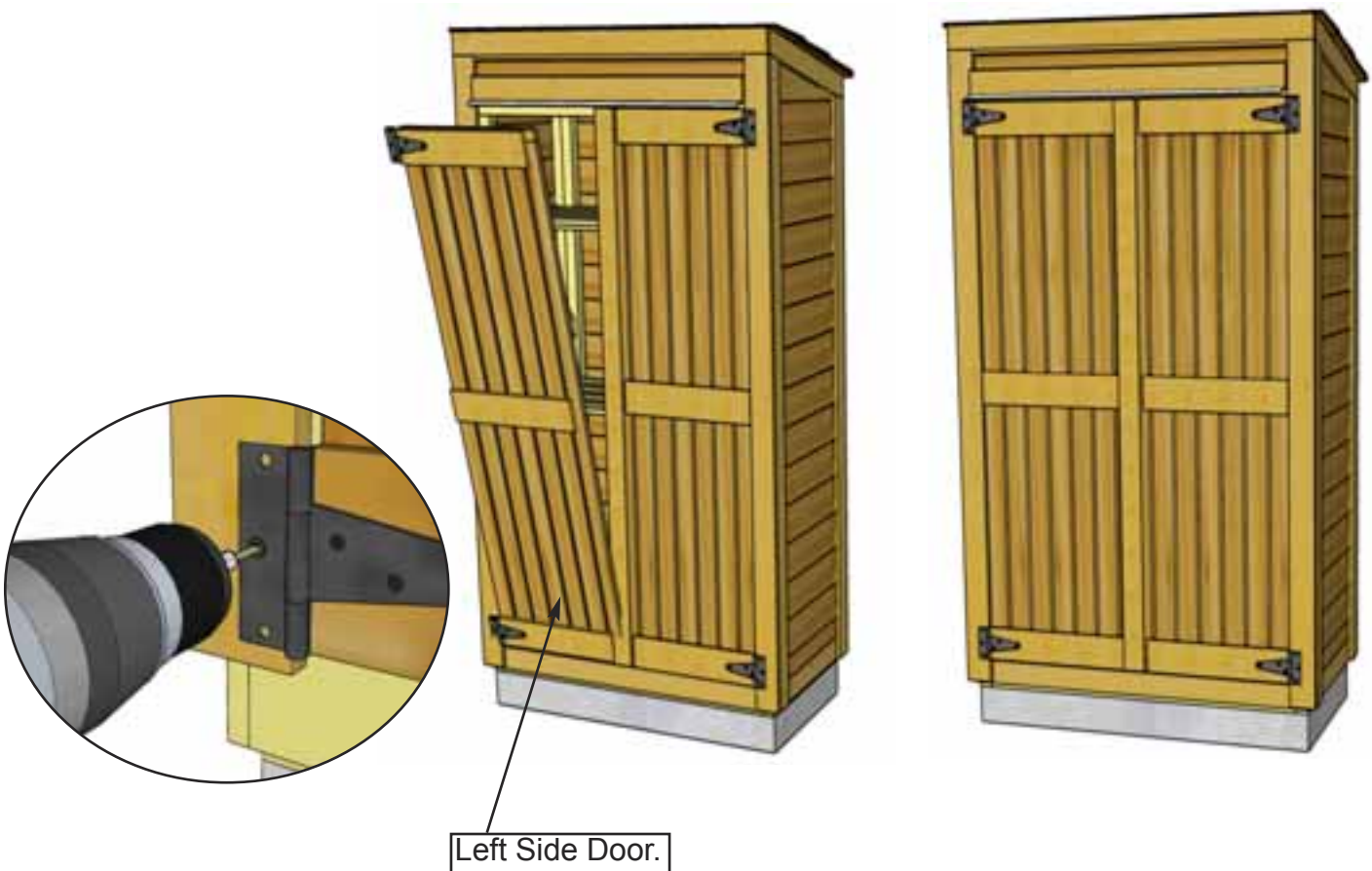

38. Position Left Side Door (with Flange) as per **Step 37**. Once again, use only 1 - 2" **Black Headed Screw** per Hinge initially to secure door to Low Wide Trim.

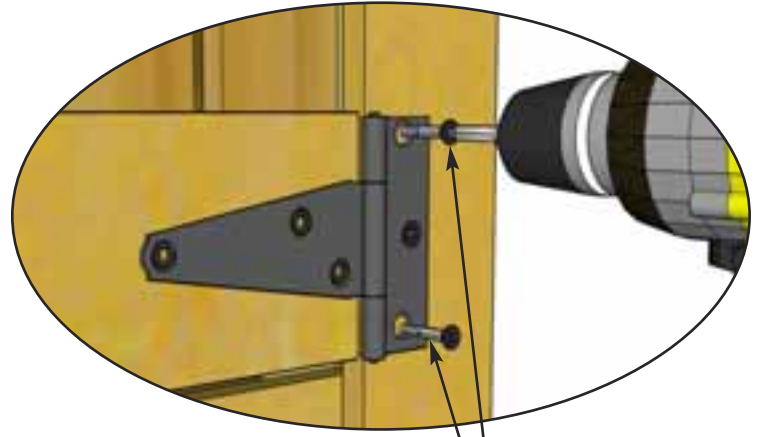

2 more - 2" Black Headed Screws per Hinge

39. With both Doors partially attached, check to see Doors open and close correctly. Make any necessary adjustments and when satisfied, completely secure Hinges to Low Wide Trims with **two more 2" Black Headed Screws** per Hinge. Drill pilot holes to prevent wood from splitting.



40. Attach **Door Handles** to Doors with **4 - 3/4" Black Headed Screws** per Handle. Choose desired Handle height.

Hardware
Black Handle x 2 total
3/4" Black Headed Screws x 8 total

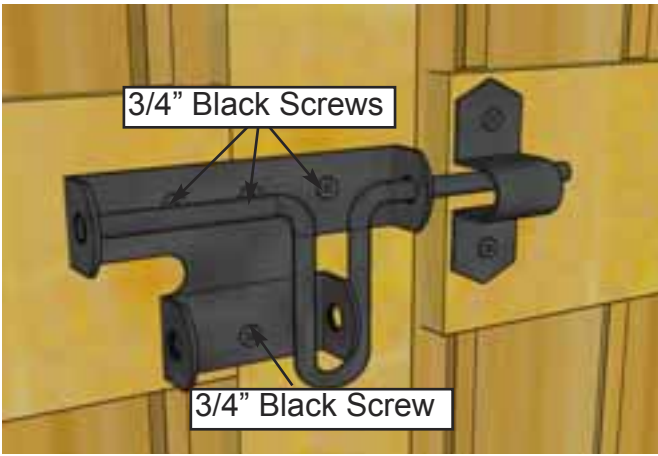

Important: Drill shallow Pilot Holes to prevent splitting.

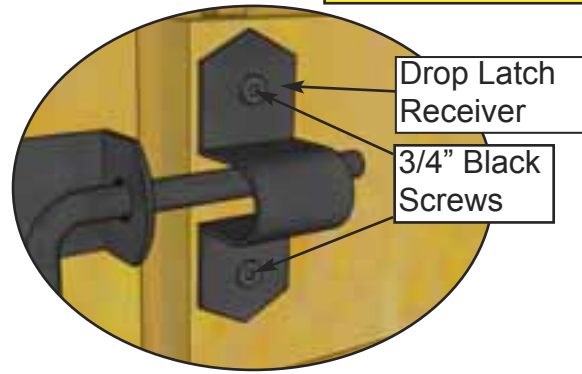

41. Attach **Black Drop Latch** as illustrated above with 6 - **3/4" Black Headed Screws**. **Note:** Black Drop Latch receiver is positioned higher than male. Do a dry run first to position Black Drop Latch correctly. **Important** - Drill pilot holes with 1/8" drill bit prior to securing with screws to prevent wood splitting.

Hardware
Black Drop Latch
3/4" Black Headed Screw x 6 total



42. Install the **Plywood Spacer** to interior door frame approximately 1 1/2" from top of door frame and 1" from edge, as pictured. Use 2 - **1 1/4" Brown Screws** to secure. Plywood Spacer should fit flush underneath Door Header when Door is closed.

Hardware
Plywood Spacer (1/2" x 2 1/2" x 2 1/2")
1 1/4" Brown Screws x 2 total



43. Position the **Interior Barrel Bolt** on the Plywood Spacer and attach with 4 - **3/4" Silver Screws**. Tap Barrel Bolt with hammer on underside of Door Header to mark location.

Hardware
Interior Barrel Bolt
3/4" Silver Screws x 4 total

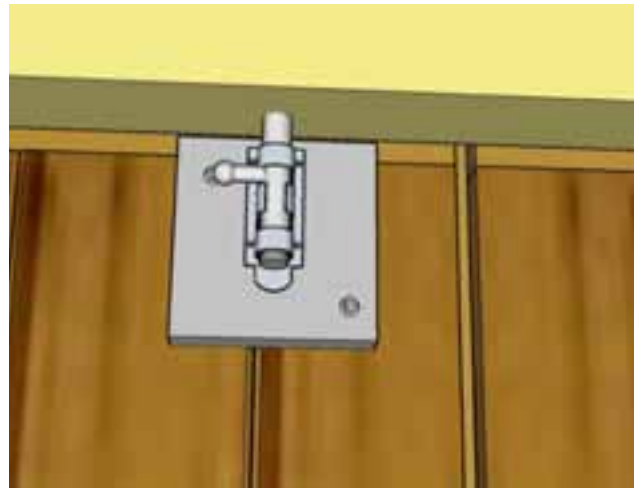

44. Open Door and drill out marked Barrel Bolt impression with a 3/8" Drill Bit. Close Door, slide Interior Barrel Bolt in drilled hole to confirm fit.



45. Using a Step Ladder, place **Roof Ridge Cap** on front row of Roof Shingles. Attach Ridge Cap with 4 - 1 1/2" Finishing Nails.

Parts
Roof Ridge Cap
 (1/2" x 3 1/2" x 46")

Hardware
1 1/2" Finishing Nails
 x 4 total



Outdoor
Living Today

Congratulations on assembling your 4x2 Garden Chalet



Note: Our Sheds are shipped as an unfinished product. If exposed to the elements, the lumber will weather to a silvery-gray color. If you prefer to keep the lumber looking closer to the original color, we suggest that you treat the wood with a good oil base wood stain. You may also wish to paint your new shed rather than stain it. In both cases we recommend that you consult with a paint and stain dealer in your area for their recommendations.

We hope your experience constructing our 4x2 Garden Chalet has been both positive and rewarding. We value your feedback and would like to hear back from you on how well we are doing in the following areas:

1. Customer Service
2. On Time Shipping
3. Motor Freight Delivery
4. Quality of Materials
5. Assembly Manual
6. Overall Satisfaction



The materials contained in this Assembly Manual may be downloaded or copied provided that ALL copies retain the copyright and any other proprietary notices contained on the materials. No material may be modified, edited or taken out of context such that its use creates a false or misleading statement or impression as to the positions, statements or actions.

Please call, write or email us at:

Canadian Address
9393 287th Street
Maple Ridge, British Columbia
Canada V2W 1L1

United States Address
P.O. Box 96
Sumas, Washington
USA 98295

Toll Line: 1.888.658.1658

| Fax: 1.604.462.5333

| sales@outdoorlivingtoday.com