

INSTALLATION MANUAL

CHANDELIER

Model No.: HLP384BL+G-10A

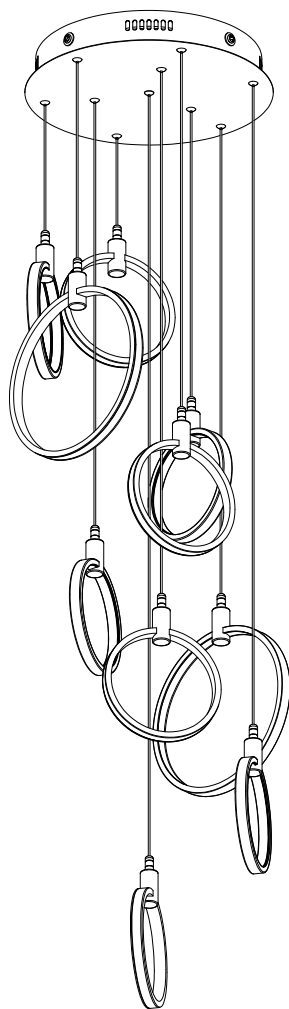

TOOLS REQUIRED



Ladder



Pliers

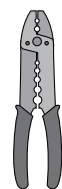

Wire
Strippers

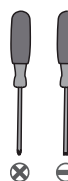

Screwdrivers







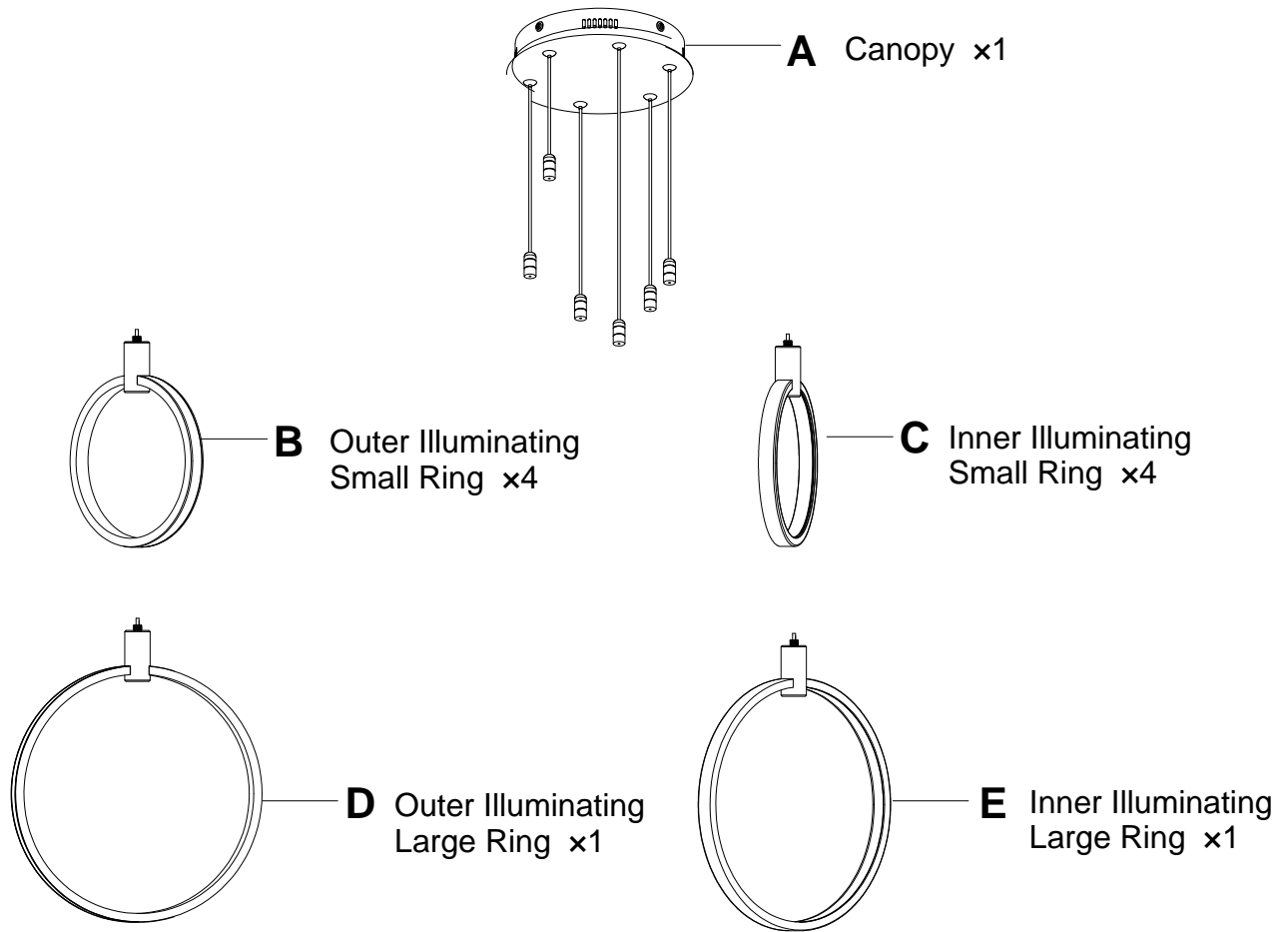

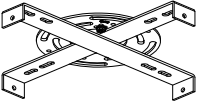

APP Control Applicable

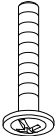
PACKING LIST



INSTALLATION KIT

AA 1×  Mounting Bracket	BB 1×  Ground Screw	CC 4×  Canopy Screw	DD 2×  Outlet Box Screw	EE 3×  Wire Nut
FF 4×  Washer	GG 4×  Wood Screw	HH 4×  Plastic Anchor	II 1×  Remote Control	JJ 1×  Gloves

NOTE:

1. For your convenience, you may receive extra hardware for back-up.
2. The ground screw (BB) have been pre-installed on the mounting bracket (AA). And the mounting bracket (AA) and canopy screws (CC) have been installed on the canopy (A).

INSTALLATION

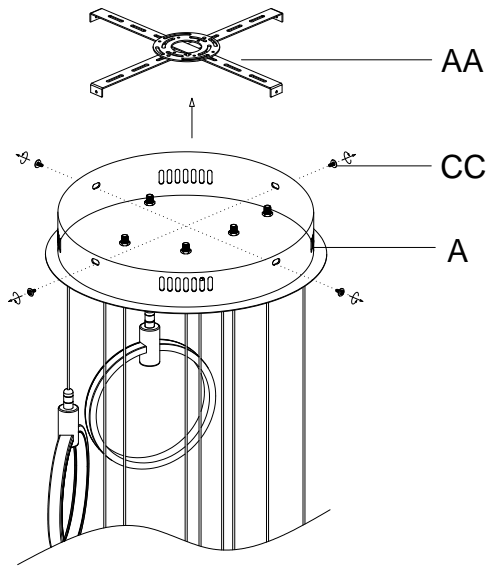

1. Take Out the Mounting Bracket

Loosen the canopy screws (CC) from the canopy (A), take out the mounting bracket (AA).

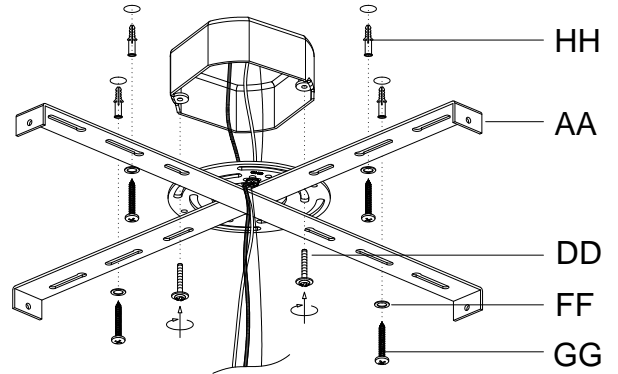

2. Install the Mounting Bracket

STEP 1: Mark and drill screw holes in the ceiling, then insert the plastic anchors (HH).

STEP 2: Take off the screws from outlet box, attach the mounting bracket (AA) to the box with screws taken off or provided (DD), and then fasten it with wood screws (GG) and washer (FF).

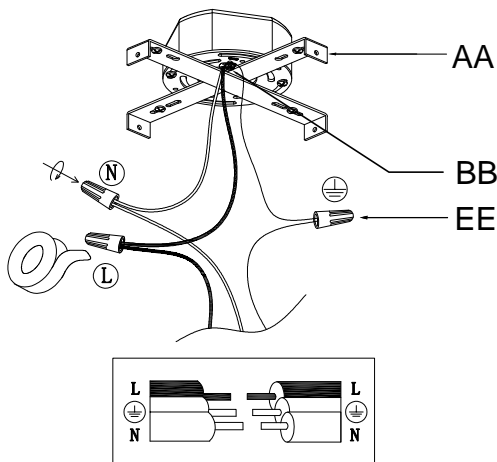

3. Connect the Wires

STEP 1: Wrap the ground wire from the outlet box around the ground screw (BB) on the bracket (AA), and then connect the ground wire from the fixture to the ground wire from the outlet box.

STEP 2: Connect the wires from the fixture to the house supply wires, neutral wire (white) to neutral wire, and hot wire (black) to hot wire. Wrap the connection with electrical tape.

STEP 3: Spread apart the wires so that the hot wires are on one side of the outlet box and the neutral wires are on the other side.

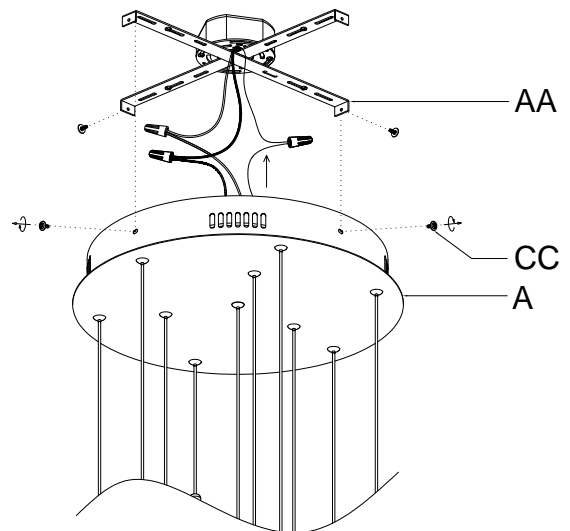

4. Fix the Canopy

Fix the canopy (A) onto the mounting bracket (AA) with canopy screws (CC) taken off.

INSTALLATION

5. Attach the Light Rings

Insert the connector into the illuminating rings (B/C/D/E) and tighten it.

NOTE:

You can choose the installation position of different types of the illuminating rings according to your personal preference.

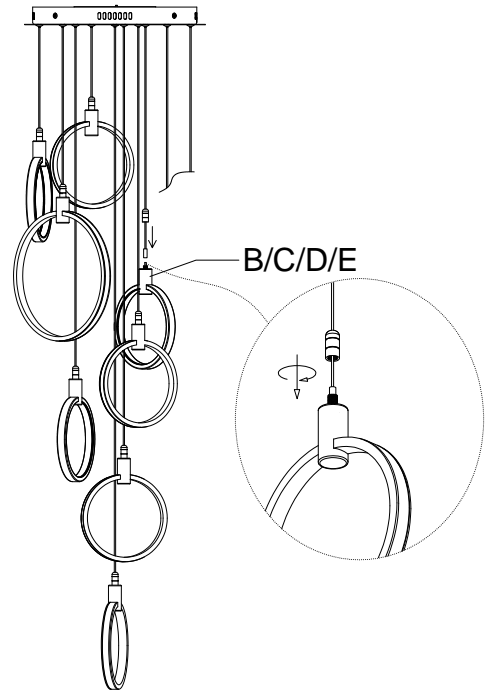

WIRE LENGTH ADJUSTMENT

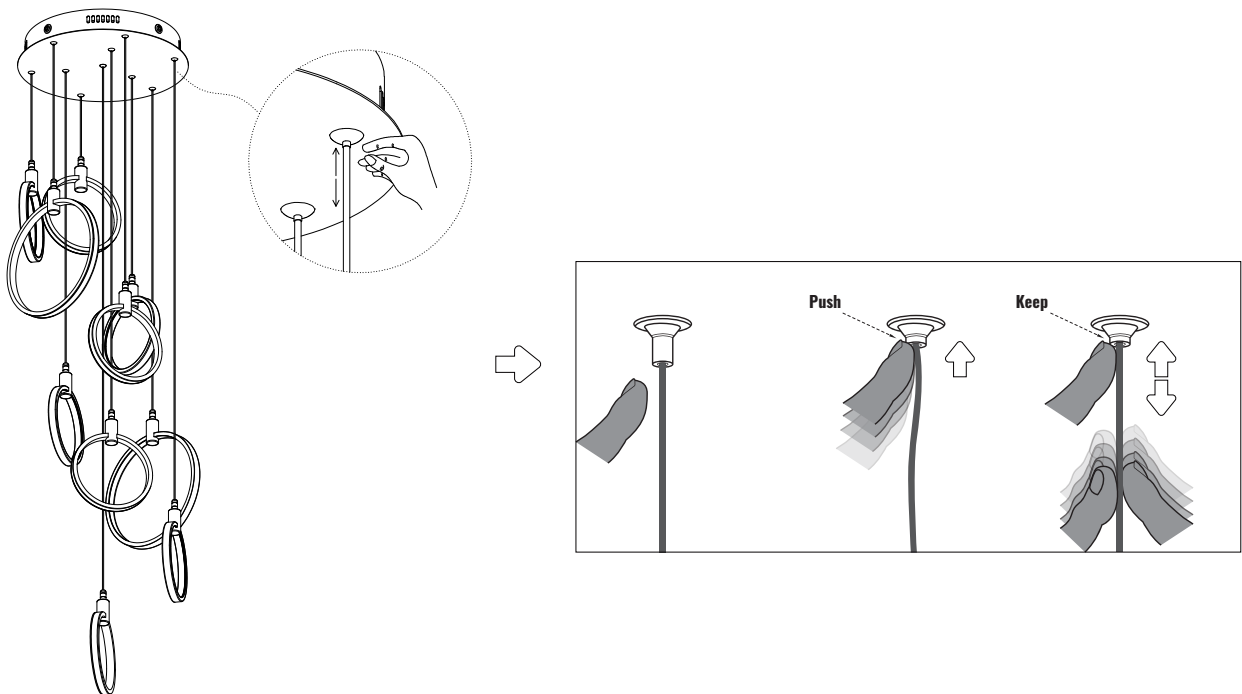

STEP 1: Using the tip of your finger or a fingernail, push the pin embedded in the ceiling canopy. This action will release the cable locking mechanism.

STEP 2: While keeping the pin in its depressed position, gently pull downward (or push upward) on the cable. Repeat this process for each cable to adjust the height of the fixture as needed.

REMOTE CONTROL INSTRUCTIONS

		Turn on/off the light.
	 	Adjust the brightness of the light.
	 	Adjust the color temperature of the light.
		White light
		Yellow light
		Quick switch of the light color: Yellow Light → White Light → Natural Light
		50% Brightness
		Night light
		Auxiliary light (Not supported)
		REMOTE SIGNAL PAIRING: If the remote control loses signal of the light, turn off the power from wall switch, then turn it on, immediately press and hold this button for around 3 seconds, the light will flash 3 times, indicating successful pairing.

NOTE:
Please insert 2 batteries before using. AAA 1.5V battery x 2pcs (not included).









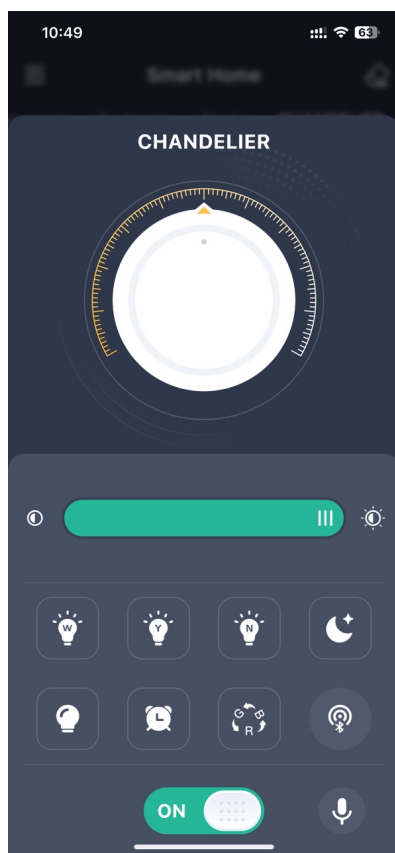

APP CONTROL INSTRUCTIONS



APP Control Applicable

Install the "Lamp Smart Pro" App from Google Play, Apple App Store, or other App Stores by scanning the QR code or searching for the App name. Ensure that your phone is connected to the internet and Bluetooth enabled.



	<p>Pair button. Click this button within 5 seconds after the device is powered on. If the device flashes or beeps, it means that the phone has been successfully paired with the device, and then the device can be controlled through the application.</p>
	<p>The state of the lamp can be adjusted by voice commands. Currently only Chinese and English are supported.</p>
	<p>Change the color temperature of the light.</p>
	<p>Change the brightness of the light.</p>
	<p>After clicking the light color will change in a cycle. (Not supported)</p>
	<p>Click to select a time to turn off the device.</p>
	<p>Click to turn on the auxiliary light. (Not supported)</p>
	<p>Night mode. The white light and the yellow light will light up at the same time, but only at 10% of the maximum brightness.</p>
	<p>When clicked, the white light and yellow light will light up at the same time, and the brightness will be the maximum brightness.</p>
	<p>When clicked, only yellow light will light up, and the brightness will be the maximum brightness.</p>
	<p>When clicked, only white light will light up, and the brightness will be the maximum brightness.</p>

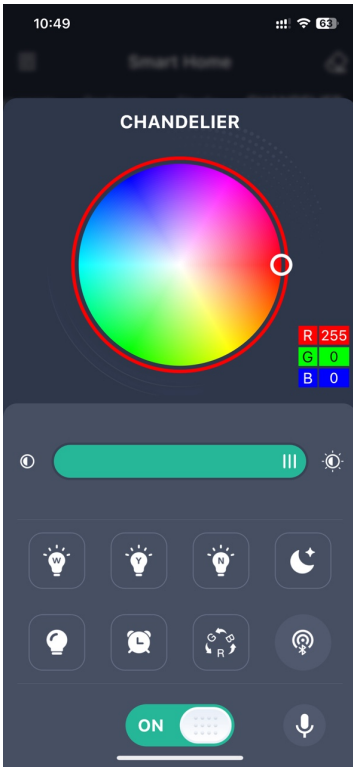

Swipe the upper part of the page to the left to switch to the RGB lamp control page.
 (The RGB feature is not supported by this product)
 The RGB lamp control page can adjust the color of the RGB lamp. (Not supported)
 The RGB lamp control page can adjust the brightness of the RGB lamp. (Not supported)

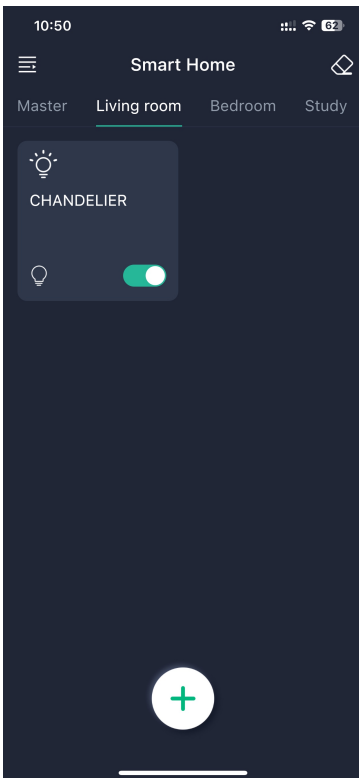

Unpair button. Click this button within 5 seconds when the device is powered on. If the device flashes or beeps, it means that the phone is unpaired with the device and the phone will not be able to control the device.







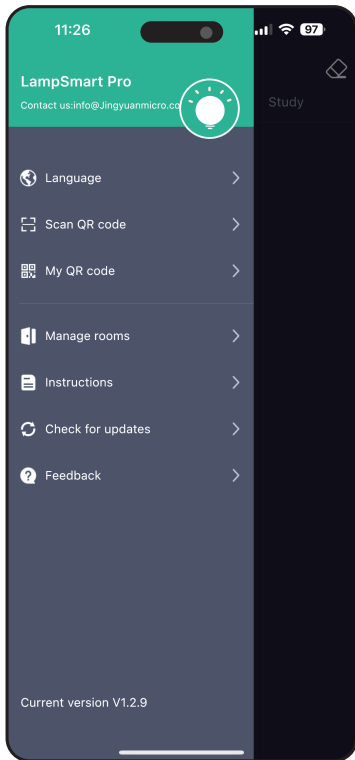

Master: Room control page. When there are devices in the room, all the devices in the room can be controlled in this page. As the above example, all the device in the living room can be controlled.
 When in the room page, long press the device card you can delete the device or change the device name.

Tips: One mobile phone is paired with the lamp and then opens the "My QR code"page. Other mobile phones open the "Scan QR code" page to scan the QR code of the mobile phone. After scanning the code successfully, other mobile phone can also control the lamp.

Master: Room control page. When there are devices in the room, all the devices in the room can be controlled in this page. As the above example, all the device in the living room can be controlled. When in the room page, long press the device card you can delete the device or change the device name.



	<p>Select the display language of the application, you can choose Chinese, English, Russian, Japanese, Korean, Spanish.</p>
	<p>Scan the QR code information shared by other mobile phones. After the code is scanned successfully, the lamps can be controlled together.</p>
	<p>Share the lamp information that can be controlled by your mobile phone application, and the other party can also control the lamp after scanning the code successfully.</p>
	<p>On this page you can add rooms, delete rooms, and modify room names.</p>
	<p>Application instructions.</p>
	<p>Get the latest version of the application.</p>
	<p>You can send your comments and suggestions by email.</p>