

seville classics®

# ULTRADURABLE®

Additional parts and accessories are available for purchase online at:

[www.SevilleClassics.com](http://www.SevilleClassics.com)



Shelf Labels  
8-Pack  
Model No.: WEB106



Shelf Liners  
(5-Pack)  
60" x 24"  
Model No.: WEB753



UltraDurable Shelf  
48" x 24"  
Model No.: SHE19528ZB



View assembly online here:

<https://www.youtube.com/watch?v=N6iRVVqBG-I>

## Caution

- Place heavier items on the lower shelves and lighter ones on the top.
- Do not stand or climb on the shelving system.
- Do not drop heavy items on the system.
- Do not move the system while loaded.

## Specifications

Dimensions: 48" W x 24" D x 76" H (72" on leveling feet), 1" Pole Diameter

Weight capacity	Per shelf	Overall
On leveling feet	<b>800 lbs.</b> (362.9 kg)	<b>4000 lbs.</b> (1814.4 lbs)
On wheels	<b>100 lbs.</b> (45.3 kg)	<b>500 lbs.</b> (226.8 kg)

## Customer Service Information

Seville Classics, Inc

Telephone: (800) 323-5565

Fax: (310) 533-3899

Hours: 8:30 AM – 4:30 PM (PST), Monday to Friday

Email: [Support@SevilleClassics.com](mailto:Support@SevilleClassics.com)

Homepage: [www.SevilleClassics.com](http://www.SevilleClassics.com)

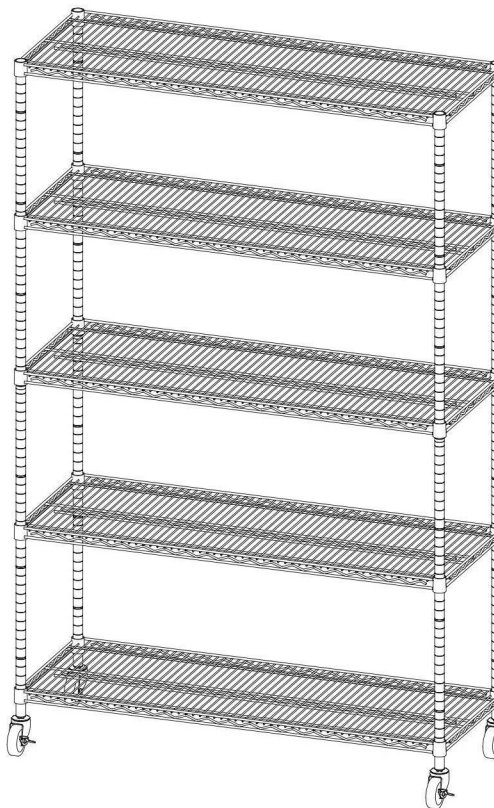





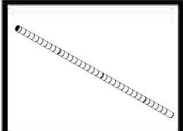

Model #: WEB564, SHE48246B

Thank you for choosing Seville Classics! We hope that you enjoy your commercial-grade steel wire shelving! Please read through this guide for parts list, assembly instructions, frequently asked questions and further contact information.

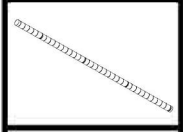
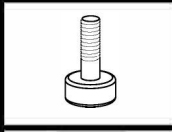
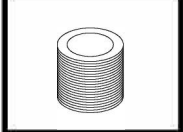
# Parts List

Please make sure you have all the parts on this list.

A. Bottom poles (4) (Threaded end)		E. Slip sleeves (20)	
B. Top poles (4) (Plastic cap on end)		F. Leveling feet (4)	
C. Connectors (4) (May be attached to poles)		G. 4" Wheels (2)	
D. Shelves (5)		H. 4" Locking wheels (2)	

If you're missing parts, contact us for replacements at (800) 323-5565 or send an email to [Support@SevilleClassics.com](mailto:Support@SevilleClassics.com)

## Assembly Instructions

### STEP 1.

Screw **LEVELING FEET (F)** or **WHEELS (G, H)** into base of bottom poles.

Repeat for all bottom poles.

### STEP 2.

Snap **SLIP SLEEVES (E)** around the grooves on **BOTTOM POLES (A)** for your lowest shelf.

**TIP!** Count the number of grooves from the bottom of the pole to keep the height consistent.

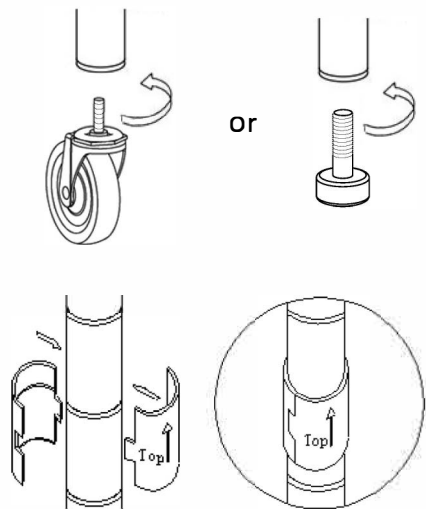

1

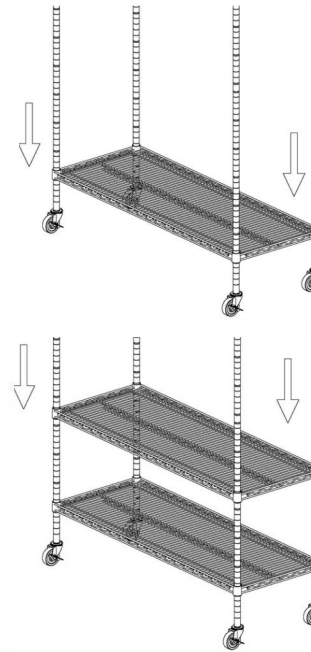

### STEP 3.

Fit **SHELF (D)** over the top of the 4 poles and over **SLIP SLEEVES (E)**.

Repeat **STEPS 2-3** for next shelf.

**TIP!** If necessary, lightly tap shelves into place with a rubber mallet.

### STEP 4.

Screw **CONNECTORS (C)** into top of **BOTTOM POLES (A)**.

Screw **TOP POLES (B)** to **CONNECTORS (C)**.

**TIP!** Connectors may be pre-installed.

### STEP 5.

Repeat **STEPS 2-3** for remaining shelves.

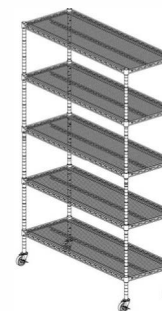
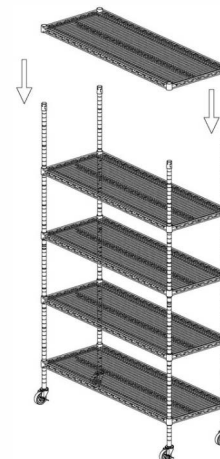
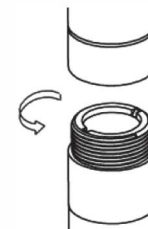

Congratulations!

Your shelving system is now assembled.

2