





Parts List

Part NO.	Picture	Description	QTY
A		Safeguard Spark Screen	1 PC
B		Log Grill	1 PC
C		Fire Bowl	1PC
D		Fire Pit Body	1PC
E		Hook Tool	1PC

Assembly Preparation

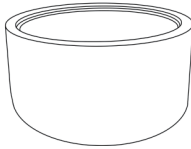
Before Beginning Assembly:

Unpack all the parts for a clear overview.

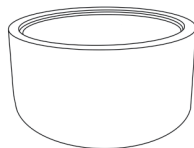

- Read instructions, cover to cover-



- Have 2 adults on hand for assembly-



- Do not assemble on flooring or carpet-



- Assemble on a clean non-marring surface (packing foam)-



- Save all packaging until finished-

Assembly Steps

OVERVIEW

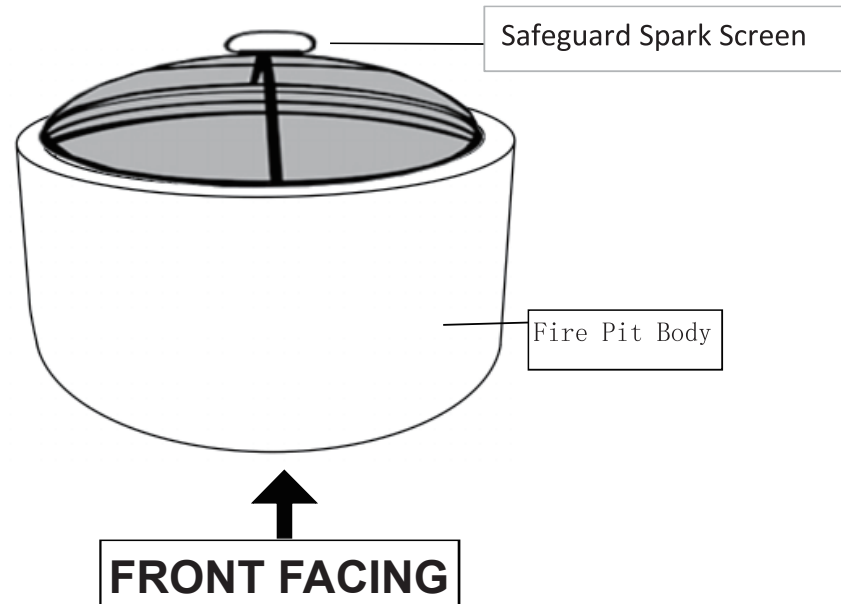

This Fire pit has multiple parts and may require up to 30 minutes to assemble.

To give you an overview of the Firepit parts, the above picture is to help you put the various Firepit parts into perspective.

Please read through the instructions below to familiarise yourself with the parts and steps before assembly.

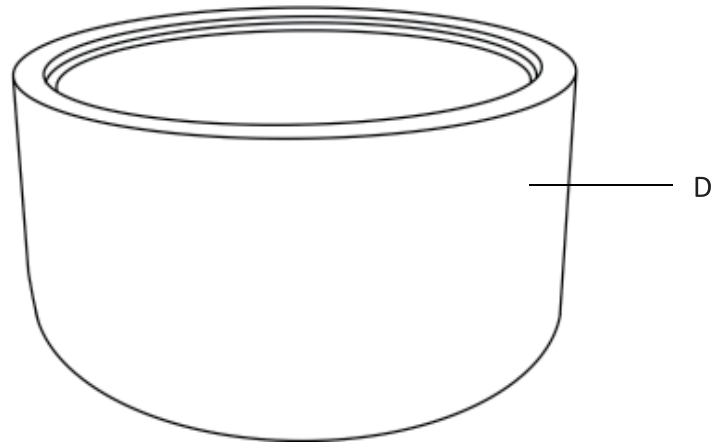

STEP1

Unpack all components carefully from the package. Put the Fire Pit Body(D) on a hard, level and non-combustible surface.

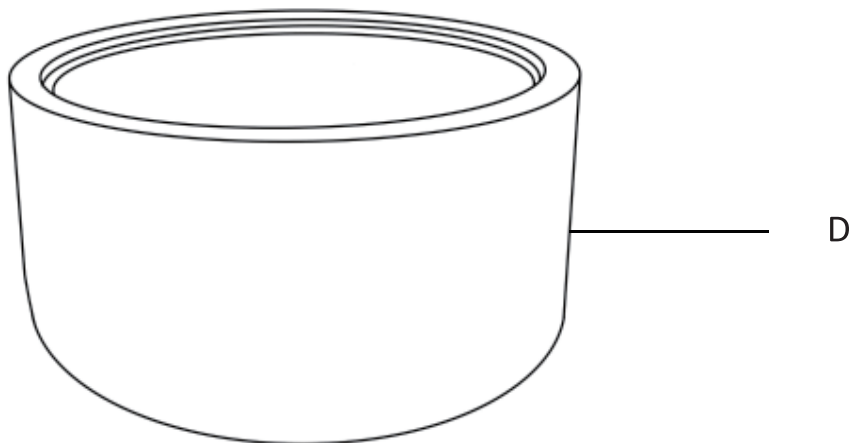

STEP2

Put the Fire Bowl(C) into the Fire Pit(D) opening as shown in step 3 above. Make sure it sits evenly in the frame housing.

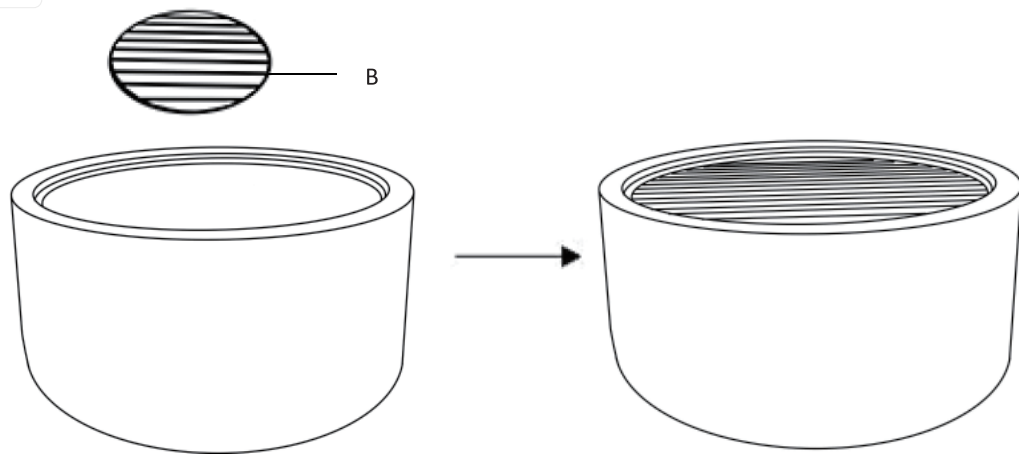

STEP3

Place the Log Grill(B) into the Fire Bowl(D).

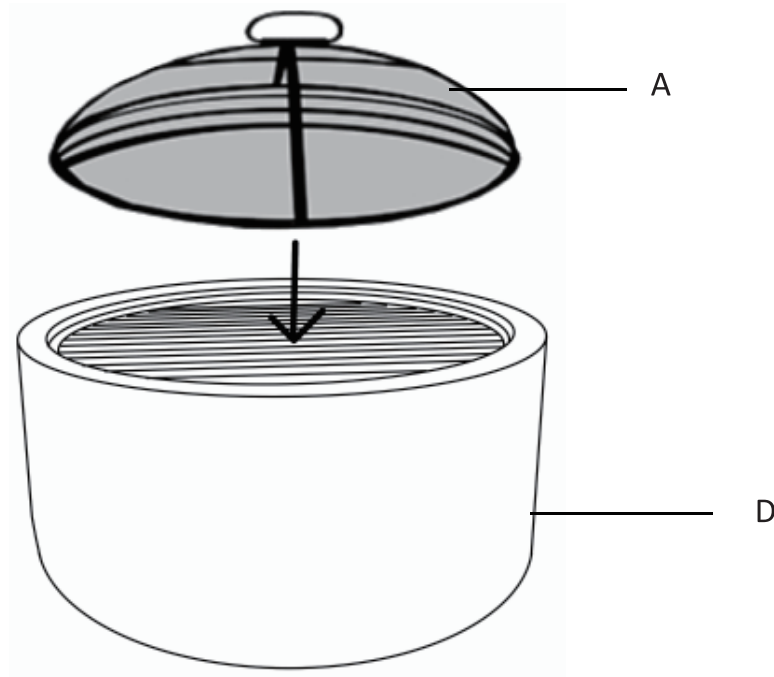

STEP4

Put the Spark Safeguard Screen(A) onto the top opening of the Fire Pit Body(E) and make sure it sits into it evenly.

The Firepit is ready for use.

CAUTION: Firepit will become hot during use and remain hot after use.

As the Firepit is hot during or after using, Please do not touch it!

KEEP CHILDREN AT BAY DURING USE !!!

Keep away from combustible material & wooden & PE Rattan furniture during use !

When not use, please be sure to put the Firepit in dry place, iron parts can't get wet in the rain water!

WARNING
FOR YOUR SAFETY

For Outdoor Use Only
(outside any enclosure)



WARNING
FOR YOUR SAFETY

1. Improper installation, adjustment, alteration, service or maintenance can cause injury or property damage.
2. Read the installation, operation, and maintenance instructions thoroughly before installing or servicing this equipment.
3. Failure to follow these instructions could result in fire or explosion, which could cause property damage, personal injury or death.

Installer: Leave these instructions with the consumer.
Consumer: Keep these instructions for future reference.

OWNER'S MANUAL

Outdoor Fire Pit

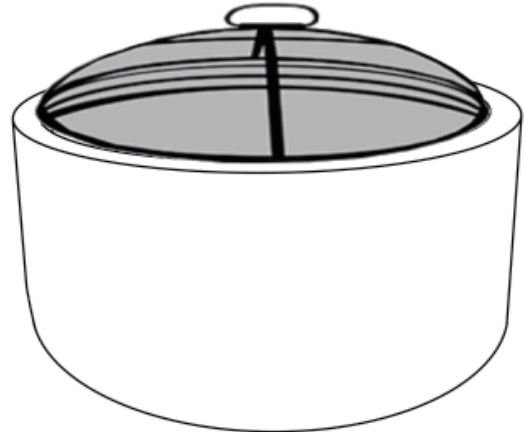

WARNING FOR YOUR SAFETY

1. This appliance is for outdoor use only, and NOT for cooking.
2. DO NOT use this outdoor fire pit in a building, garage, boats, recreational vehicles, or any other enclosed area.
3. This outdoor fire pit is not to be operated by children.
4. Always use in accordance with all applicable local, state and national codes. Contact your local fire department for details on outdoor burning.
5. When using this outdoor fire pit, exercise the same precautions you would do with any open fire.
6. The use of alcohol, prescription or non-prescription drugs may impair the consumer's ability to properly assemble or safely operate this outdoor Fire pit.
7. Do NOT use this outdoor fire pit without reading the entire „Owner's Manual“.
8. This outdoor fire pit is for use with dry, seasoned hardwood. It will burn hotter, more completely and create less smoke. Do NOT burn charcoal briquets, lump charcoal, manufactured logs, driftwood, trash, leaves, paper, cardboard, painted or stained or pressure treated wood. Avoid using soft wood such as pine or cedar that can throw sparks.
9. Do not use this outdoor fire pit until it is completely assembled. Do not alter this fire pit in any manner.
10. Do NOT use gasoline or other flammable vapors or liquids in the vicinity of this or any other appliance.
11. Do NOT store or use an LP gas cylinder within 10 feet (3.05m) of this outdoor fire pit while it is in operation.
12. Do NOT use this outdoor Fire pit near automobiles, trucks, vans, recreational vehicles, electrical cords or any other combustible objects.
13. Always use this outdoor fire pit on a hard, level, non-combustible surface.
14. The appliance must be inspected before each use. Always empty the fire pit before use. Leave a thin layer of ash (1/2" thick) to protect the bottom of the fire bowl.
15. The safeguard spark screen must be used while burning.
16. Do NOT use in windy conditions.
17. Do NOT wear flammable or loose clothing when operating this outdoor fire pit.
18. Do NOT use gasoline, kerosene, diesel fuel, lighter fluid or alcohol to light or relight fires.
20. Children and adults should be alerted to the hazards of high surface temperatures and keep a safe distance to avoid burns or clothing ignitions.
21. Do not touch any part of the appliance until it is completely cooled down. Never touch the ashes to see if they are hot.
22. Use long, sturdy fire pit tools to add or move logs, including to take away the safeguard spark screen and replace it.
23. Never leave a lit fire pit unattended.
24. Children should be carefully supervised where they are anywhere near the Fire pit.
25. Clothing or other flammable materials should NOT be hung from the appliance, or place on or near the appliance.
26. Do NOT attempt to move or store this outdoor fire pit until the appliance is completely cooled down.
27. Do NOT move ashes until they are completely and fully extinguished.
28. Do NOT add additional firewood until the fire burns down.
29. Burning must be inside the metal bowl. Never burn firewood on the faux stone fire pit body, otherwise it would destroy the appliance.
30. Do NOT put any hot part of the fire pit onto combustible surfaces such as grass, wooden deck or furniture.
31. All above must be exactly followed.

Operating Instructions:



WARNING FOR YOUR SAFETY

Before using this outdoor fire pit, make sure you have read, understood and are following all information provided on page 1 of this manual. Failure to follow those instructions can cause death, serious injury or property damage.

Lighting:

1. Make sure there is only a small amount of ash (1/2" thick) at the bottom of the metal bowl.
2. Place a layer of dry kindling or a natural firestarter onto the center of the log rack.
3. Place above that layer the dry seasoned hardwood that is cut to lengths no more than 12".
4. Use a match to light kindling or firestarter.
5. Replace the safeguard spark screen when the kindling or firestarter is lit.

Tending the Fire

You may need to shift and/or add logs for an ideal experience.

Reminders:

- ⌘ Always wear protective gloves or a pot holder when tending a fire.
 - ⌘ Wait until glowing wood have developed before adding any additional wood.
 - ⌘ Do NOT add gasoline, kerosene, diesel fuel, lighter fluid or alcohol to relight or enhance an existing fire.
1. Use a long handled fire pit tool to carefully take away the spark screen.
 2. Use the long handled fire pit tool to shift the logs to allow additional airflow.
 3. If additional wood is required, place wood on top of the burning log. Be careful not to shift ashes.
 4. Replace the safeguard spark screen.

Extinguishing

1. Allow fire to burn itself out.
2. Do NOT use water to extinguish as this is dangerous and can cause damage to this outdoor fire pit.

Maintenance Instructions:

Inspecting

This outdoor fire pit should be inspected on a regular basis to ensure product safety and longer product life.

Check all parts to make sure they are secure.

Cleaning

This outdoor fire pit should be cleaned on a regular basis to promote safer experiences and longer product life.

Note: After repeated use, a slight discoloration of the finish may occur.

Reminders:

- ⌘ Do NOT attempt to clean this outdoor fire pit until the fire is COMPLETELY out.
 - ⌘ Do NOT use oven cleaner or abrasive cleaners as they will damage this product.
 - ⌘ Do NOT clean any part of this outdoor fire pit in a self-cleaning oven as it may damage the finish.
1. Wipe exterior surfaces of the metal parts with a mild dishwashing detergent or baking soda.
 2. For stubborn surfaces on the metal parts, use a citrus based degreaser and a nylon scrubbing brush.
 3. Rinse clean on the metal with water.
 4. Use a soft dry brush to wipe away the dust on the faux stone fire pit body. Never use water or other liquids to clean the faux stone top.

Storage

Do NOT move or store this outdoor fire pit until the fire is COMPLETELY out.

1. Once the fire is out, logs are cold and outdoor fire pit is cool to the touch, remove ashes and properly dispose.
2. Store assembled in a location away from children and pets.

Note: If you do not use a cover, store this outdoor fire pit in a dry location free from rain.