

# Assembly | Asambla | Assemblage

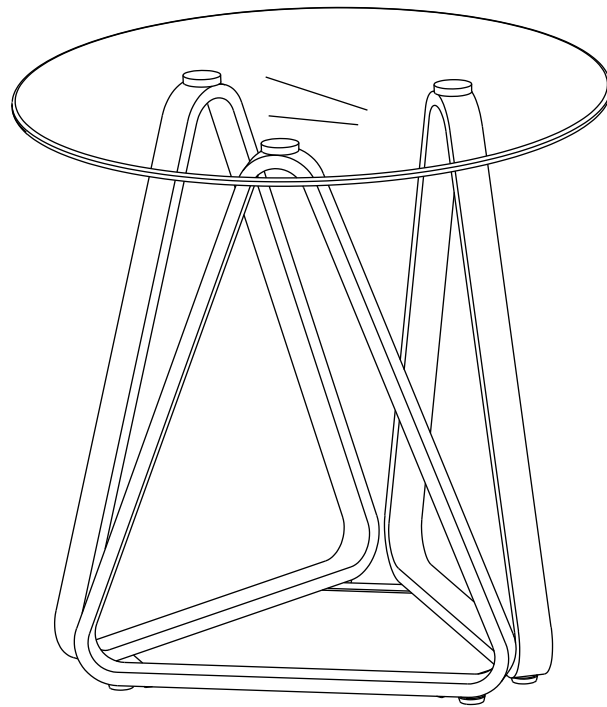

# Assembly | Asamblea | Assemblage

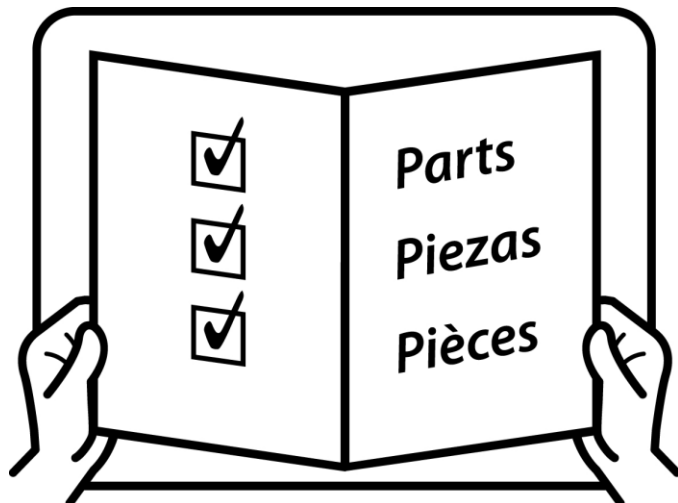
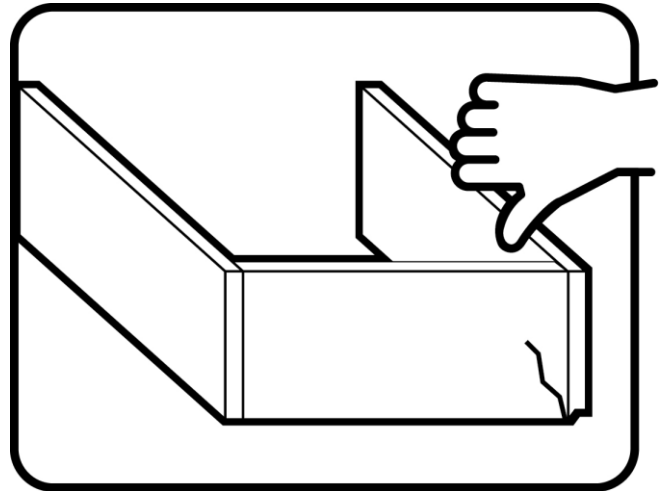
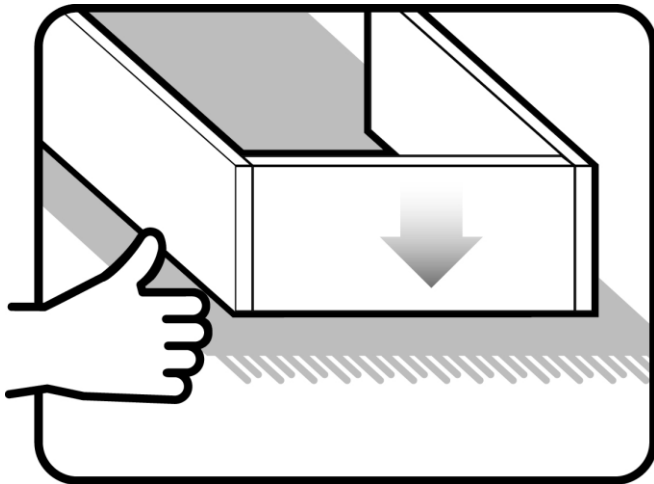
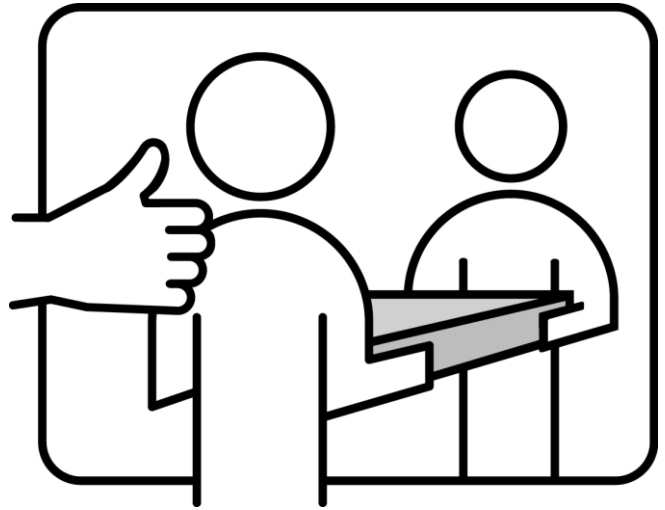
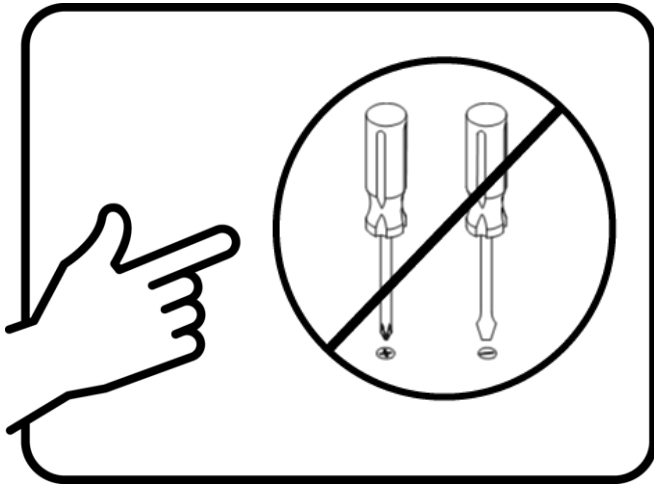

# Assembly | Asamblea | Assemblage

Techniques | Técnicas | Techniques

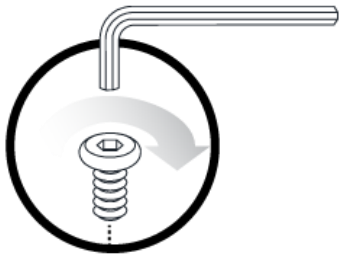

Care | Cuidado | Entretien







Safety | Seguridad | Sécurité



Note! | ¡Nota! | Remarque!

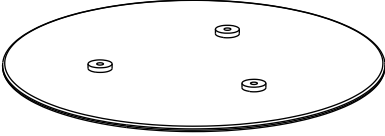
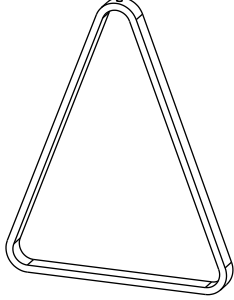

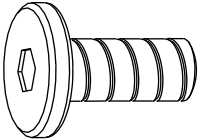
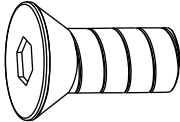
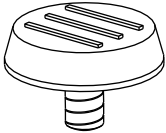

# Assembly | Asamblea | Assemblage

<p>1</p>  <p>Glass top Tapa de cristal Plateau en verre</p>	<p>2</p>  <p>Base Base Base</p>
<p>3</p>  <p>Connector Conector Connecteur</p>	
<p>A</p>  <p>Bolt Tornillo Boulon</p> <p>1/4"x5/8"</p>	<p>B</p>  <p>Bolt Tornillo Boulon</p> <p>1/4"x1/2"</p>
<p>C</p>  <p>Leveler Nivelador Niveleur</p>	<p>D</p>  <p>Allen wrench Llave Allen Clé Allen</p>

# Assembly | Asambla | Assemblage

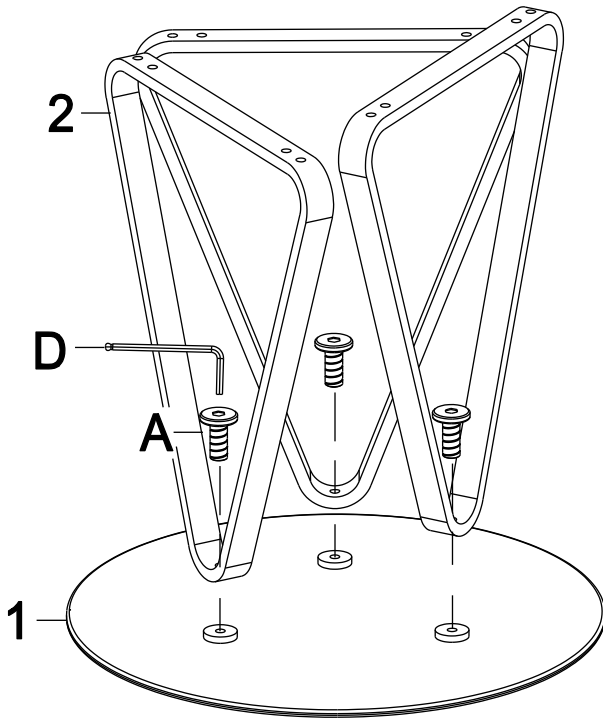

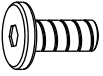
1

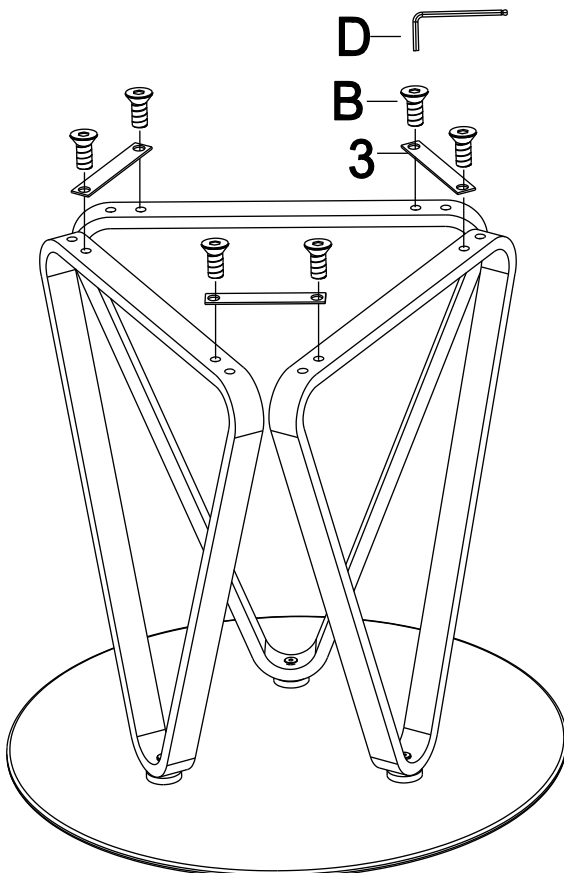

A		X3
D		X1

2

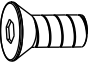

B		X6
D		X1

# Assembly | Asambla | Assemblage

3

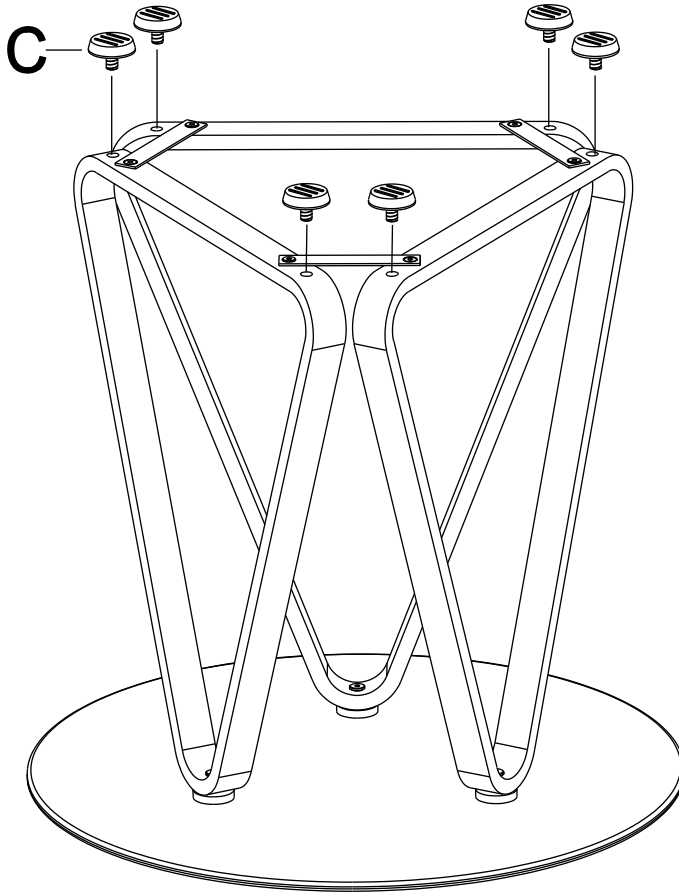

C		X6
---	---	----

# Assembly | Asamblea | Assemblage

Please immediately examine this product carefully. Any request for missing or damaged parts replacement must be received 90 days following the date you received the product. Requests for replacement parts, if available, will be honored within this time frame. Parts will not be available for items that were received fully assembled. We do not recommend modifying products and we are not responsible for any damages due to product modifications. If damages or missing parts are not reported within 90 days of the date you received the product, we are under no obligation to provide parts or replacement merchandise. For product issues,

Por favor, examine este producto detenidamente. Cualquier solicitud de reemplazo de piezas faltantes o dañadas debe recibirse 90 días después de la fecha en que recibió el producto. Las solicitudes de piezas de repuesto, si están disponibles, se cumplirán dentro de este marco de tiempo. Las piezas no estarán disponibles para los artículos que se recibieron completamente ensamblados. No recomendamos modificar los productos y no nos hacemos responsables de los daños debidos a modificaciones del producto. Si los daños o las piezas faltantes no se informan dentro de los 90 días a partir de la fecha en que recibió el producto,

S'il vous plaît examiner immédiatement ce produit avec soin. Toute demande de remplacement de pièces manquantes ou endommagées doit être reçue dans les 90 jours suivant la date de réception du produit. Les demandes de pièces de rechange, si elles sont disponibles, seront honorées dans ce délai. Les pièces ne seront pas disponibles pour les articles reçus entièrement assemblés. Nous ne recommandons pas de modifier les produits et nous ne sommes pas responsables des dommages causés par les modifications du produit. Si les dommages ou les pièces manquantes ne sont pas signalés dans les 90 jours suivant la date à laquelle vous avez reçu le produit, nous ne sommes pas

Please note, for items purchased in a retail store, you will need to contact the retailer for all part needs.

Product purchased at garage sales or discount stores is sold as-is and is not covered by the above policy.

Tenga en cuenta que para los artículos comprados en una tienda minorista, deberá ponerse en contacto con el minorista para todas las necesidades de la pieza.

El producto comprado en las ventas de garaje o tiendas de descuento se vende tal cual y no está cubierto por la política anterior.

S'il vous plaît noter, pour les articles achetés dans un magasin de détail, vous devrez contacter le détaillant pour tous les besoins en pièces.

Les produits achetés dans les ventes de garage ou dans les magasins discount sont vendus tels quels et ne sont pas couverts par la politique cidessus.