

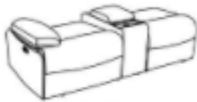





ASSEMBLY INSTRUCTION

Thank you for purchasing this quality product. Be sure to check all packing materials carefully for small parts, which may have come loose during shipment. Check the bottom of seat, identify and count all items and compare with the parts list shown below.

Please follow below Assembly Instruction step by step

LOVESEAT

Parts List		
A 1PC  Seat	B 1PC  Left Backrest	
C 1PC  Right Backrest	D 1PC  Console Backrest	
E 1PC  Ear	F 3PC  Knob Screws	G 1SET  AC Adapter

All images shown are for illustration purpose only. Actual product may vary due to product enhancement.

STEP1 Check bottom of loveseat console, Open flap to find a zipper compartment.

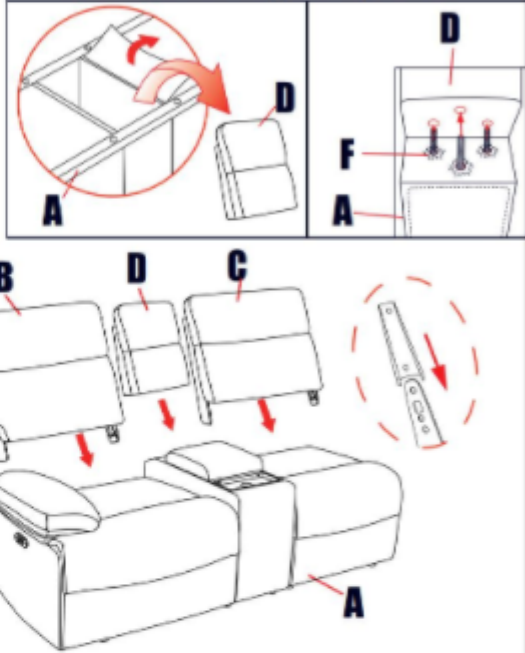

The diagram illustrates the first step of assembly. It shows the seat (A) and the three backrests (B, C, D) being attached to the seat. A callout shows the console flap being opened to reveal a zipper compartment containing knob screws (F) and the AC adapter (G).

STEP2

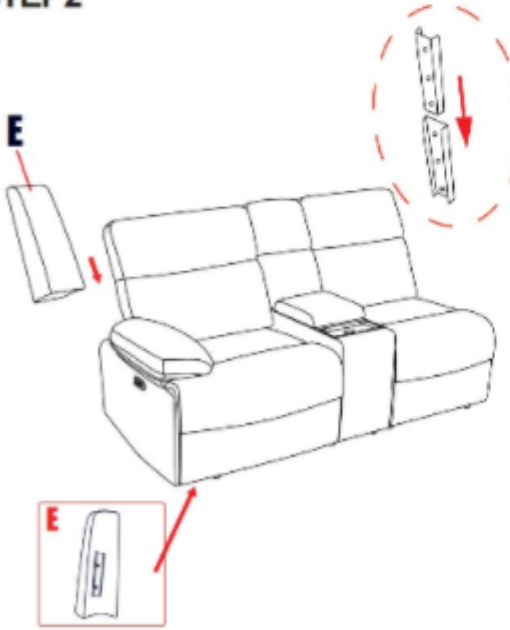

The diagram shows the ear (E) being inserted into the bottom of the seat. A callout shows the ear being pushed into a slot.

⚠ The ear at the bottom of seat

STEP3

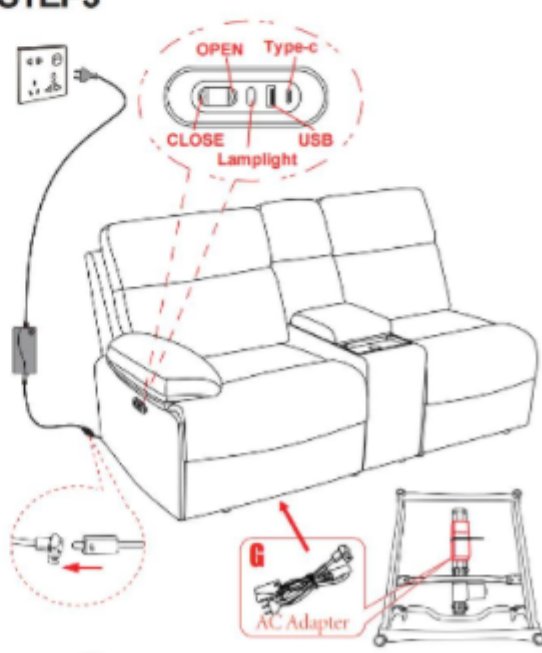

The diagram shows the AC adapter (G) being inserted into the bottom of the seat. A callout shows the AC adapter being pushed into a slot. Another callout shows the USB Type-c cable being connected to the seat's port. The port is labeled with 'OPEN Type-c', 'CLOSE USB', and 'Lamp Light'.





⚠ The AC Adapter at the bottom of seat

ASSEMBLY INSTRUCTION

Thank you for purchasing this quality product. Be sure to check all packing materials carefully for small parts, which may have come loose during shipment. Check the bottom of seat, identify and count all items and compare with the parts list shown below.

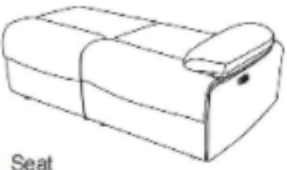
Please follow below Assembly Instruction step by step

SOFA

Parts List			
A		1PC	
B		1PC	
C		1PC	
D		1PC	
E		1SET	

All images shown are for illustration purpose only.
Actual product may vary due to product enhancement.

STEP1

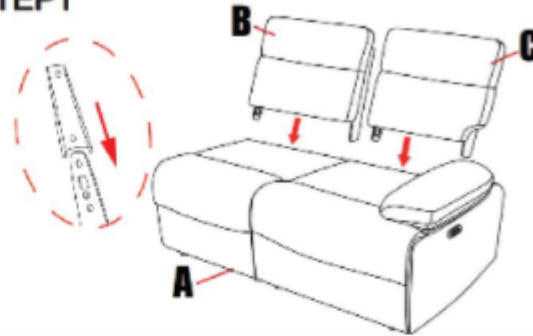

STEP2

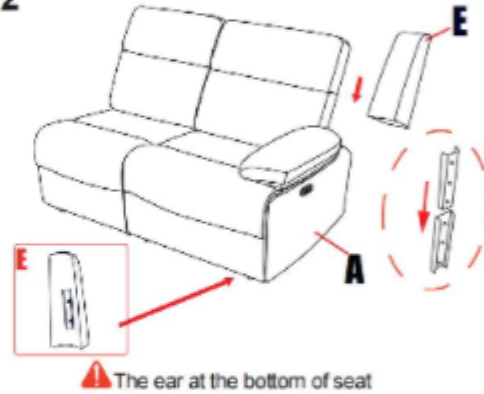

STEP3

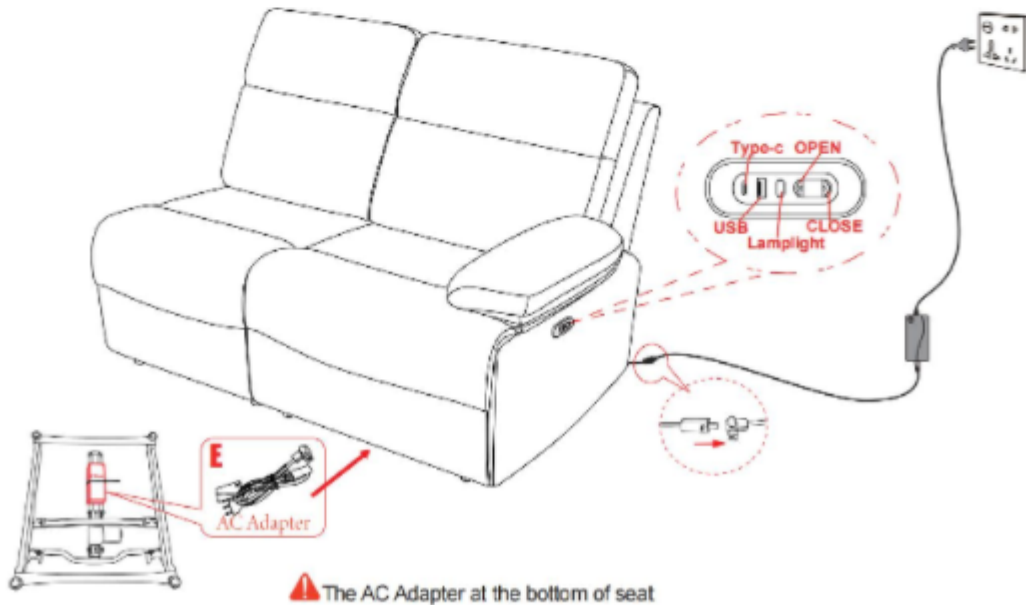





ASSEMBLY INSTRUCTION

Thank you for purchasing this quality product. Be sure to check all packing materials carefully for small parts, which may have come loose during shipment. Check the bottom of seat, identify and count all items and compare with the parts list shown below.

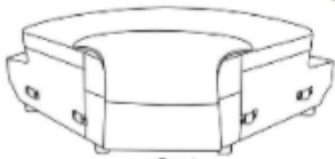
Please follow below Assembly Instruction step by step

WEDGE

Parts List	
A	1PC  Seat
B	1PC  Left Backrest
C	1PC  Right Backrest
D	5PC  Leg

STEP1

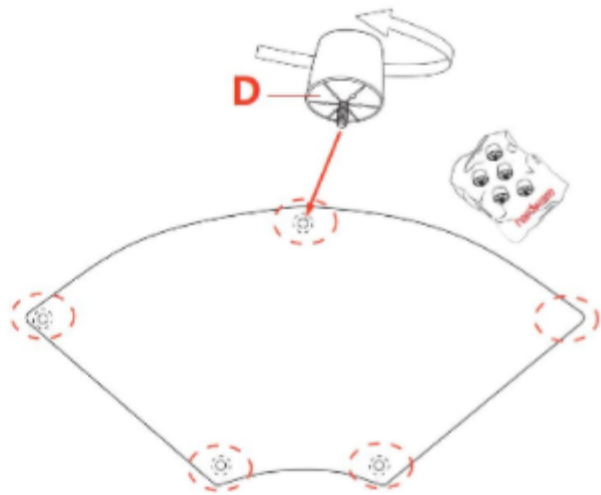

All images shown are for illustration purpose only.
Actual product may vary due to product enhancement.

STEP2

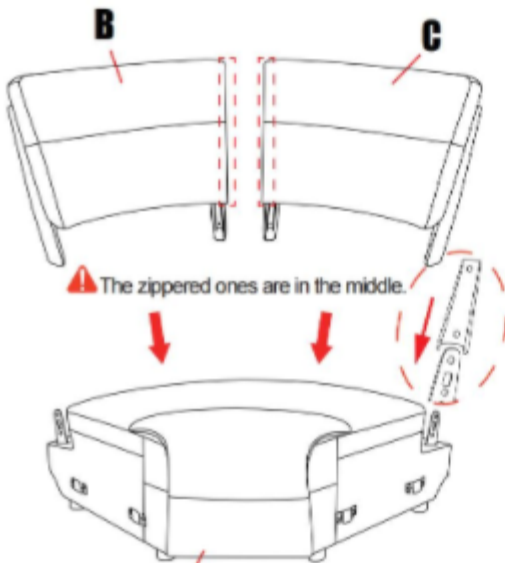

▲ The zippered ones are in the middle.

▲ The ear at the bottom of seat

STEP3

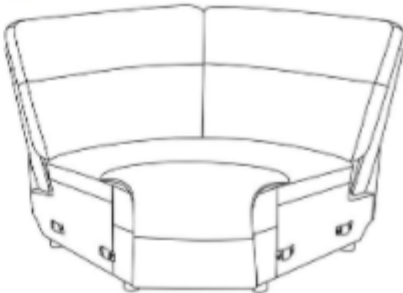

STEP4

