

# RECTANGULAR DINING TABLE

*Instruction manual*

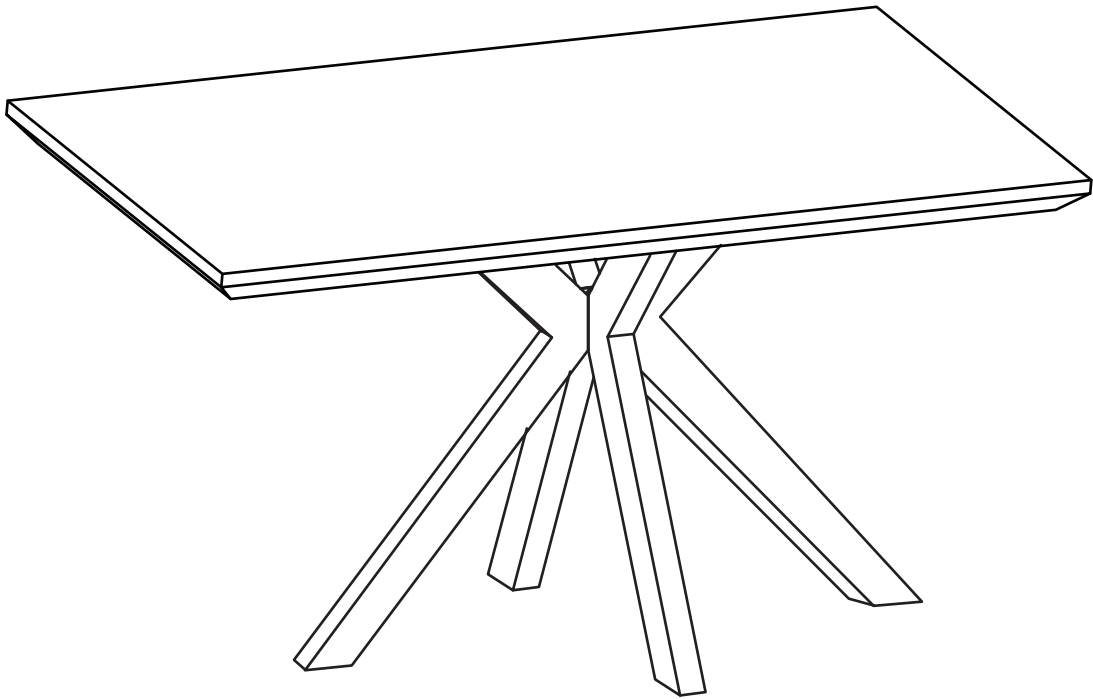



# SAFETY AND CARE ADVICE









PLEASE READ THESE INSTRUCTIONS CAREFULLY AND KEEP FOR FUTURE

- Check you have all the components and tools listed on pages 2 or 3.
- Remove all fittings from the plastic bags and separate them into their groups.
- Keep children and animals away from the work area, small parts could choke if swallowed.
- Make sure you have enough space to layout the parts before starting.
- Do not stand or put weight on the product, this could cause damage.
- Assemble on a soft level surface to avoid damaging the unit or your floor (use opened out unit carton).
- We do not recommend the use of power drill/drivers for inserting screws, as this could damage the unit. Only use hand screwdrivers.



# COMPONENTS — PANELS

---

<b>A</b>  <b>X1</b>	<b>B</b>  <b>X2</b>	<b>C</b>  <b>X2</b>
<b>D</b>  M8*25mm <b>X8</b>	<b>E</b>  M8*16mm <b>X4</b>	<b>F</b>  M8*18mm <b>X12</b>
<b>G</b>  5# <b>X1</b>	<b>H</b>  <b>X1</b>	<b>I</b>  <b>X1</b>

# ASSEMBLY INSTRUCTIONS

---

step1

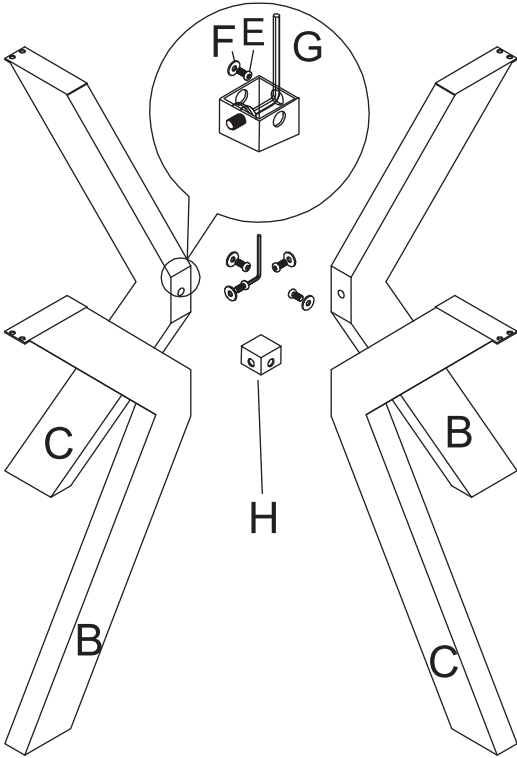

step2

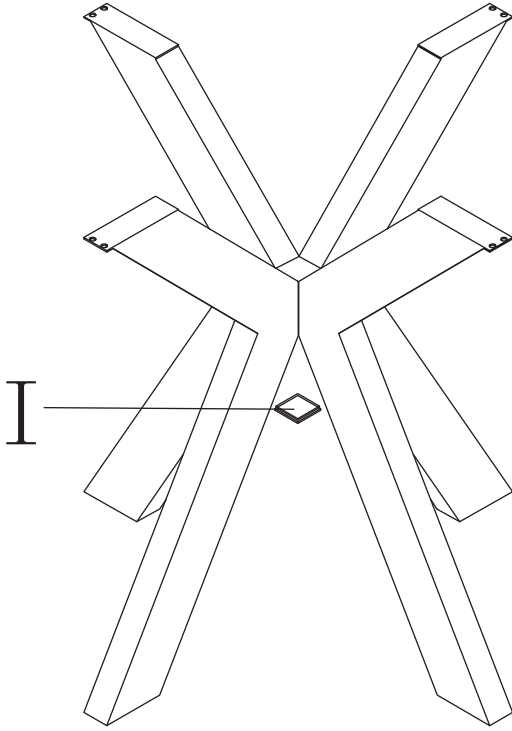

# ASSEMBLY INSTRUCTIONS

---

step3

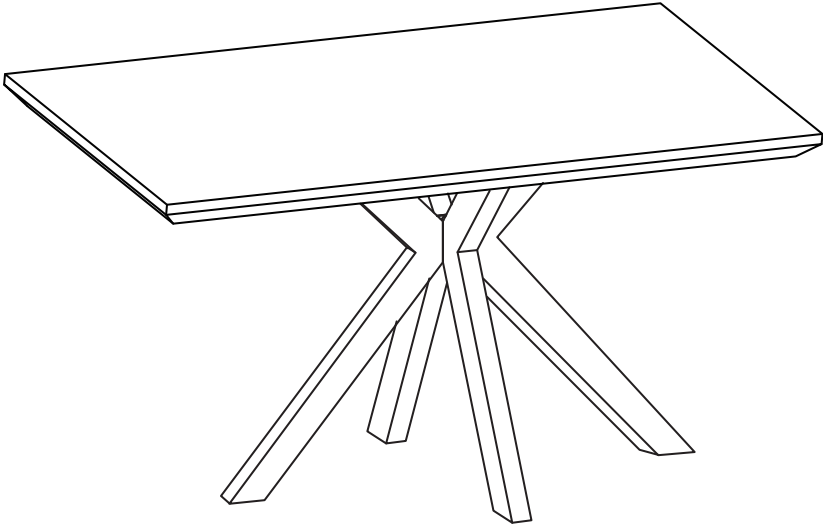
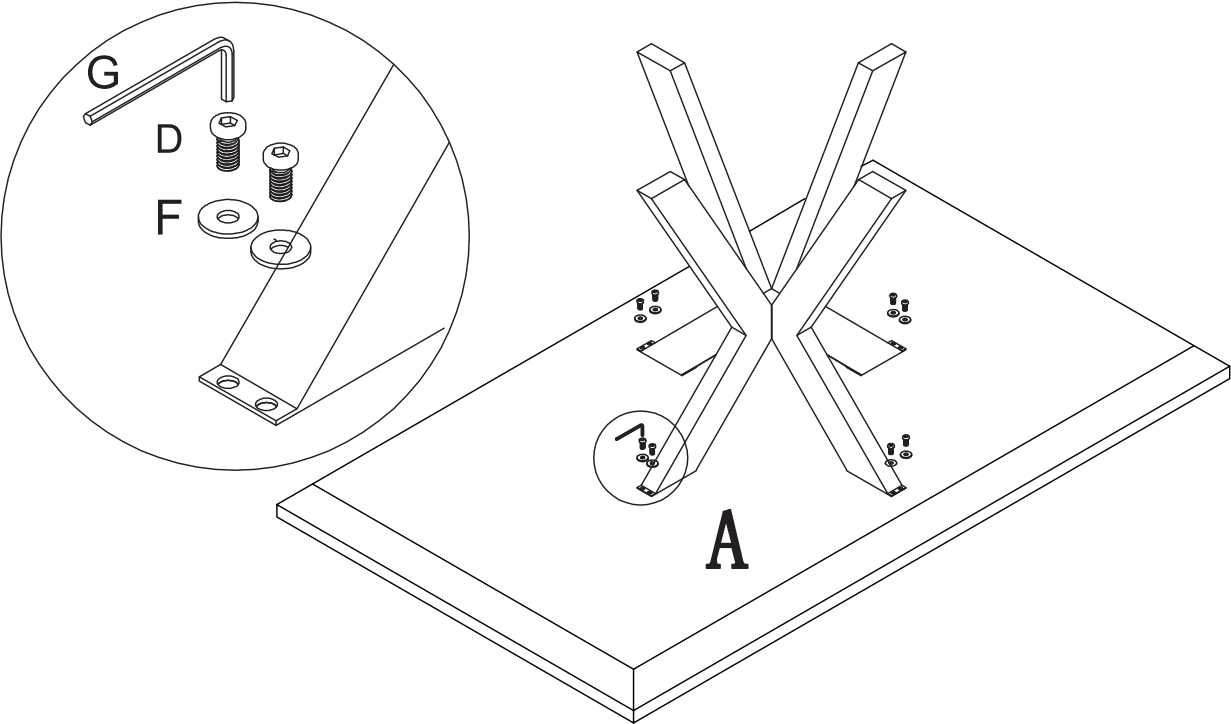

*Congratulations!  
Now you have finished assembling the product.*