

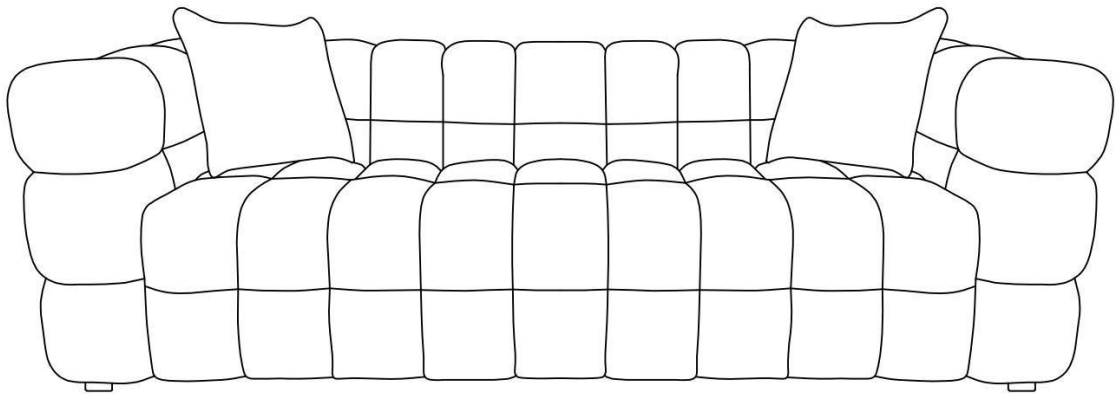

ASSEMBLY INSTRUCTION

SOFA

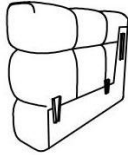
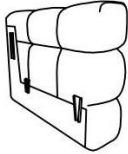
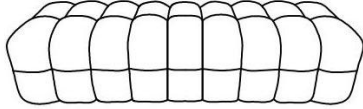
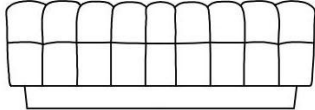

PART LIST

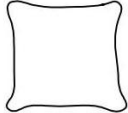
No.	Picture	Description	QTY
AL		Left Armrest	1
AR		Right Armrest	1
B		Seat	1
C		Backrest	1
D		Leg	5
E		Pillow	2

Assembly Preparation

Before Beginning
Assembly:

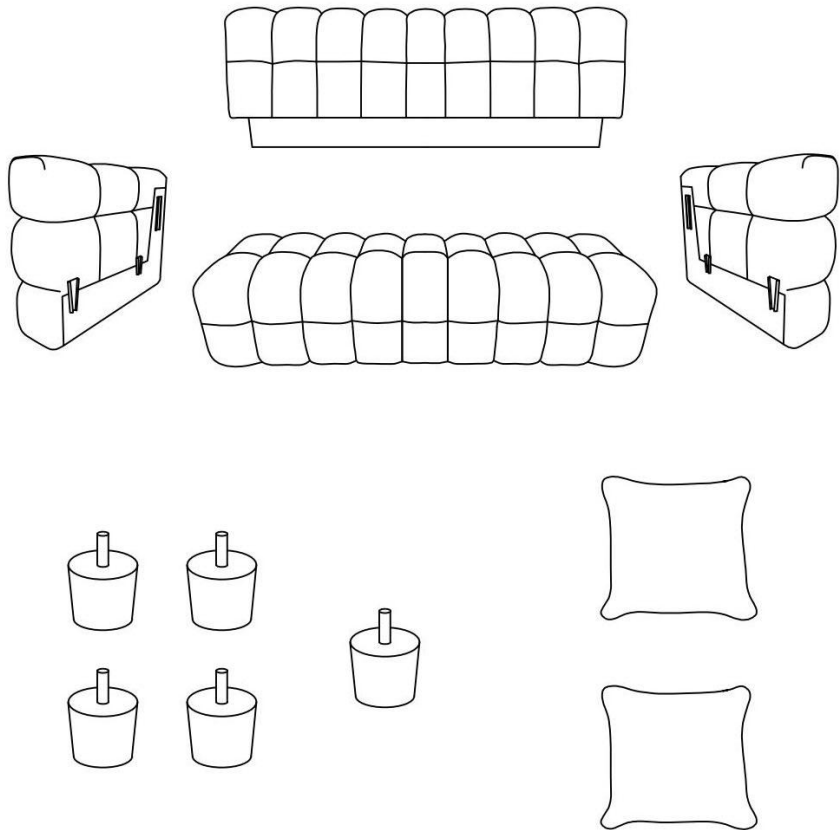

● Read instructions, cover to cover.



● Have 2 adults on hand for assembly.



● Do not assemble on flooring or carpet.



● Assemble on a clean non-marring surface (packing foam).



● Save all packaging until finished.

Step1

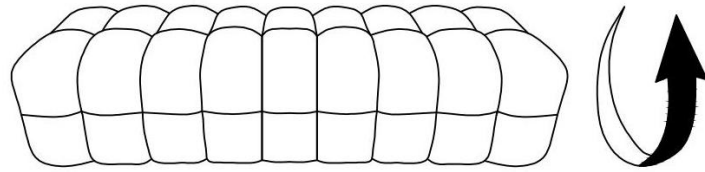

Turn the Seat over to face the bottom.

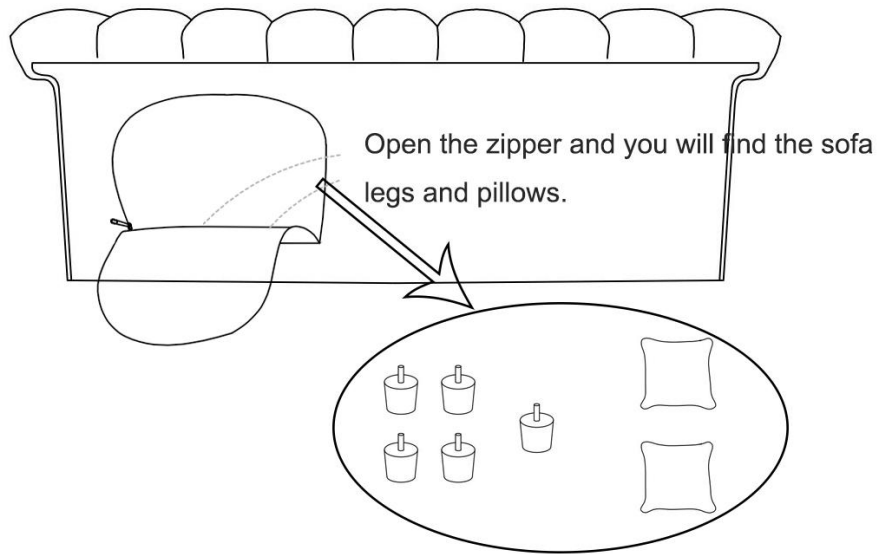

Step2

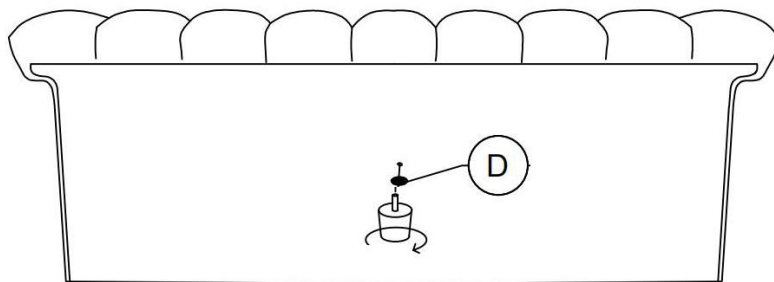

Rotate and screw the sofa leg into the pre-built screw holes.

Step3

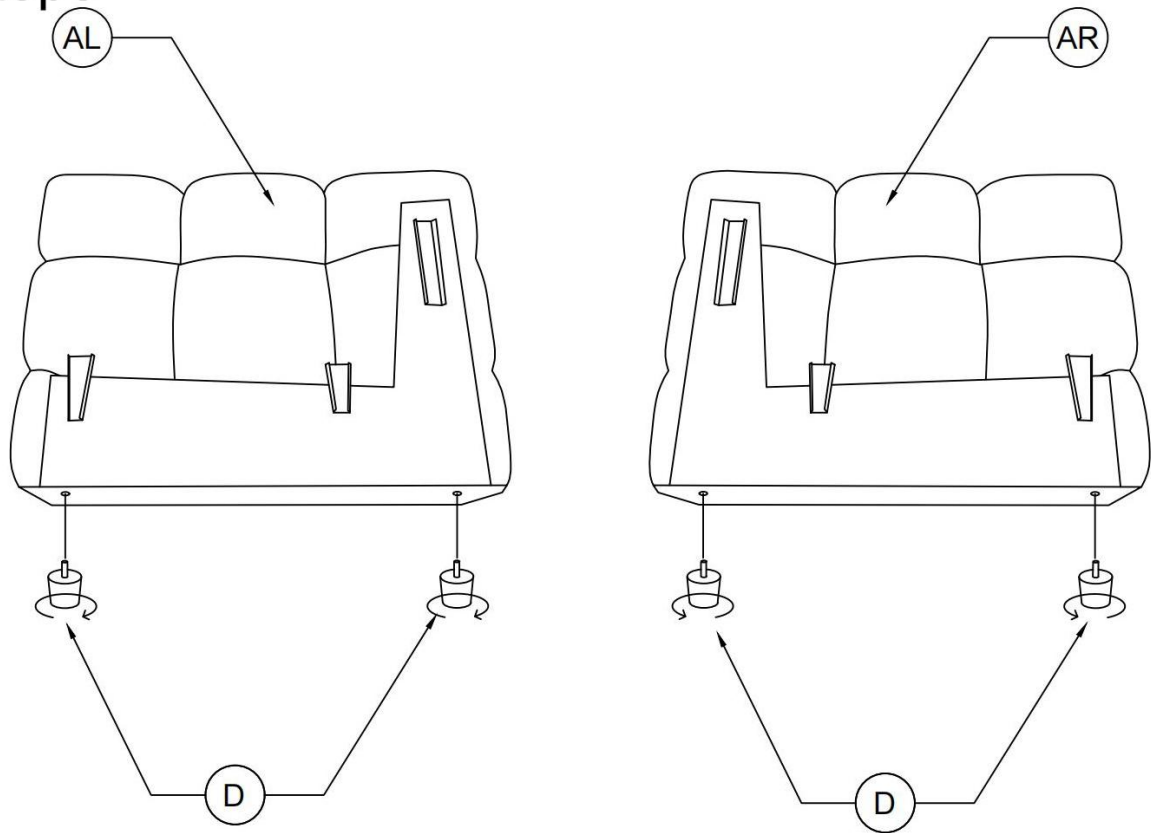

Step4

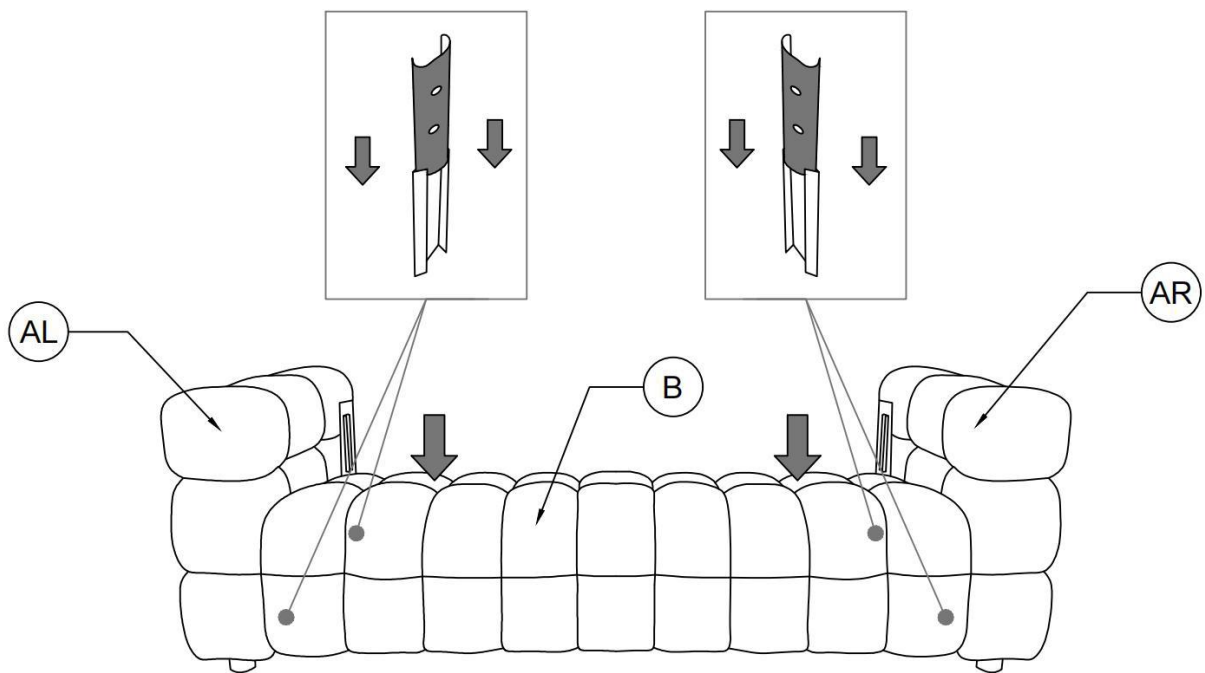

Step5

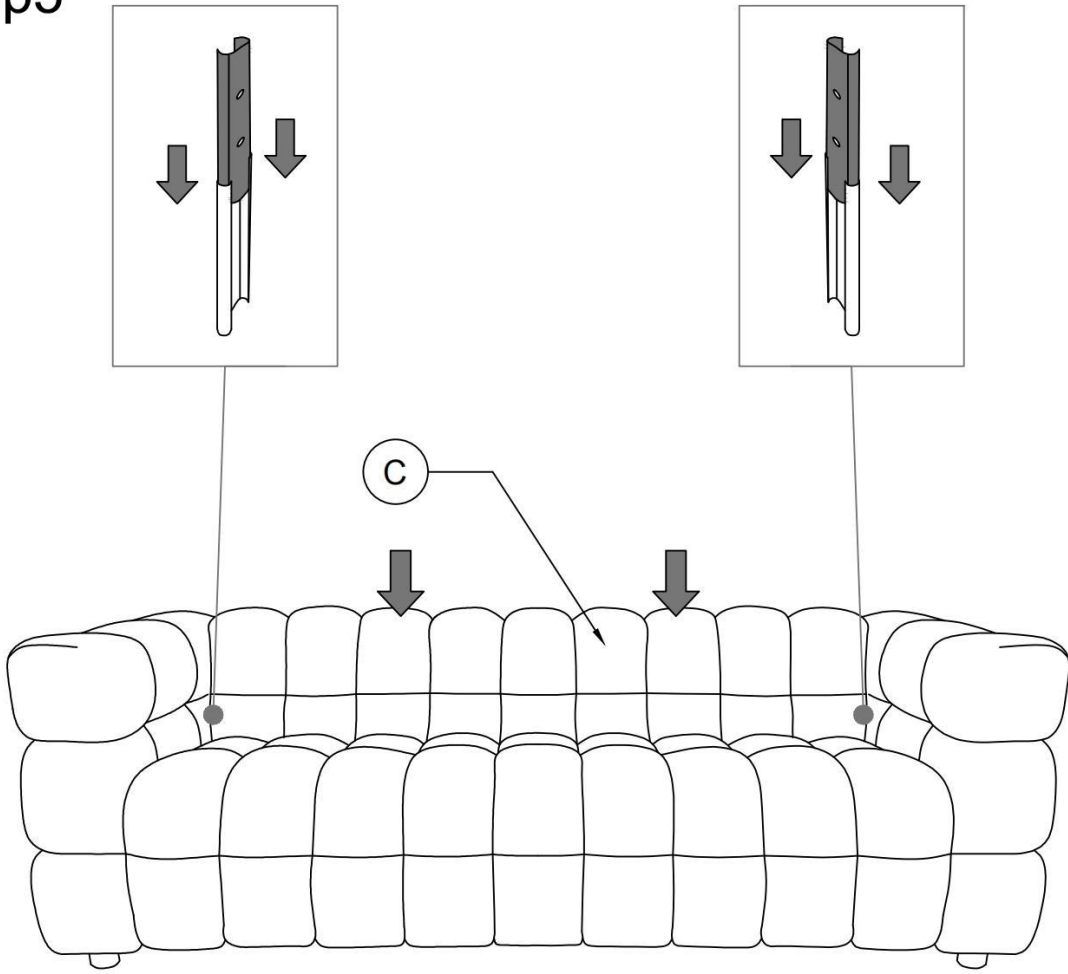

Step6

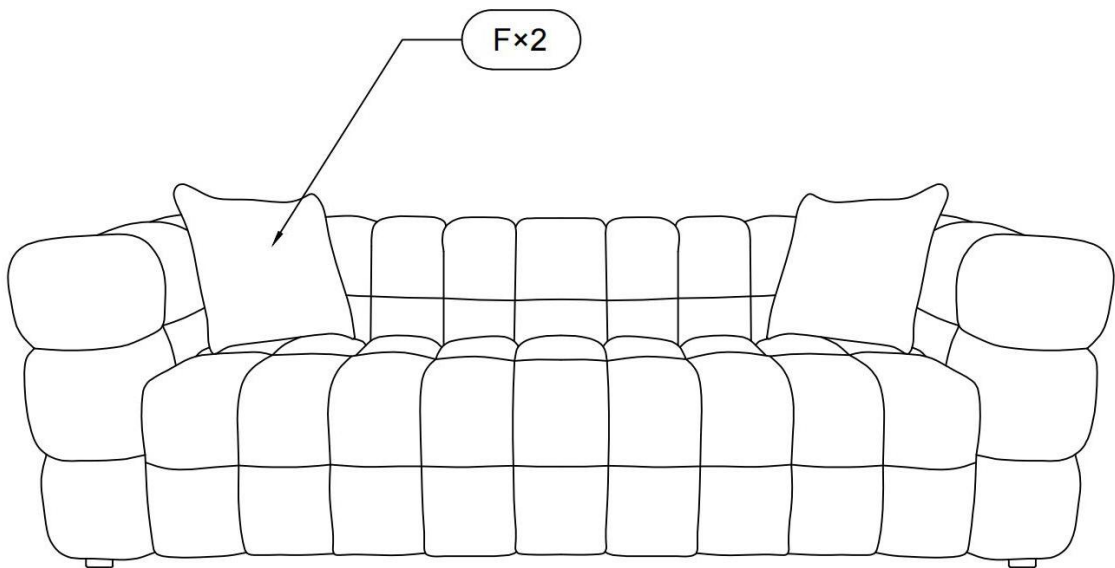



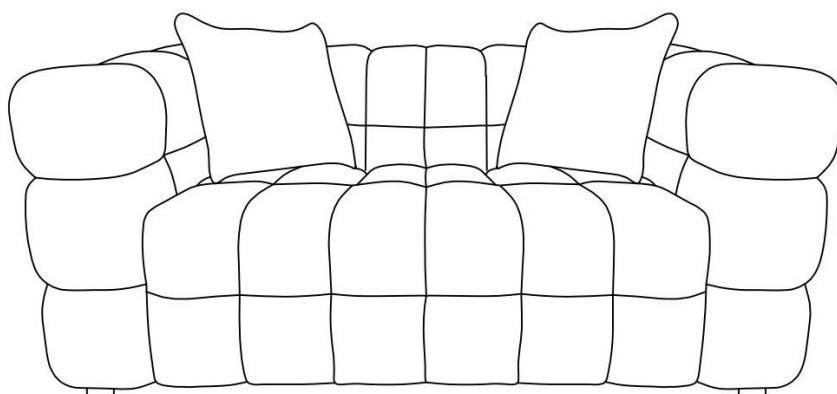

ASSEMBLY INSTRUCTION

LOVESEAT

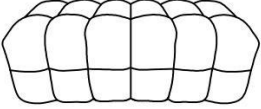
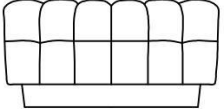

PART LIST

No.	Picture	Description	QTY
AL	 A line drawing of a left armrest, showing a curved, padded surface with two horizontal segments and a small vertical support on the right side.	Left Armrest	1
AR	 A line drawing of a right armrest, showing a curved, padded surface with two horizontal segments and a small vertical support on the left side.	Right Armrest	1
B	 A line drawing of a seat, showing a rectangular, padded surface with multiple vertical segments.	Seat	1
C	 A line drawing of a backrest, showing a rectangular, padded surface with multiple vertical segments and a small base.	Backrest	1
D	 A line drawing of a leg, showing a cylindrical shape with a small vertical support on top.	Leg	4
E	 A line drawing of a square pillow with slightly rounded corners.	Pillow	2

Assembly Preparation

Before Beginning Assembly:

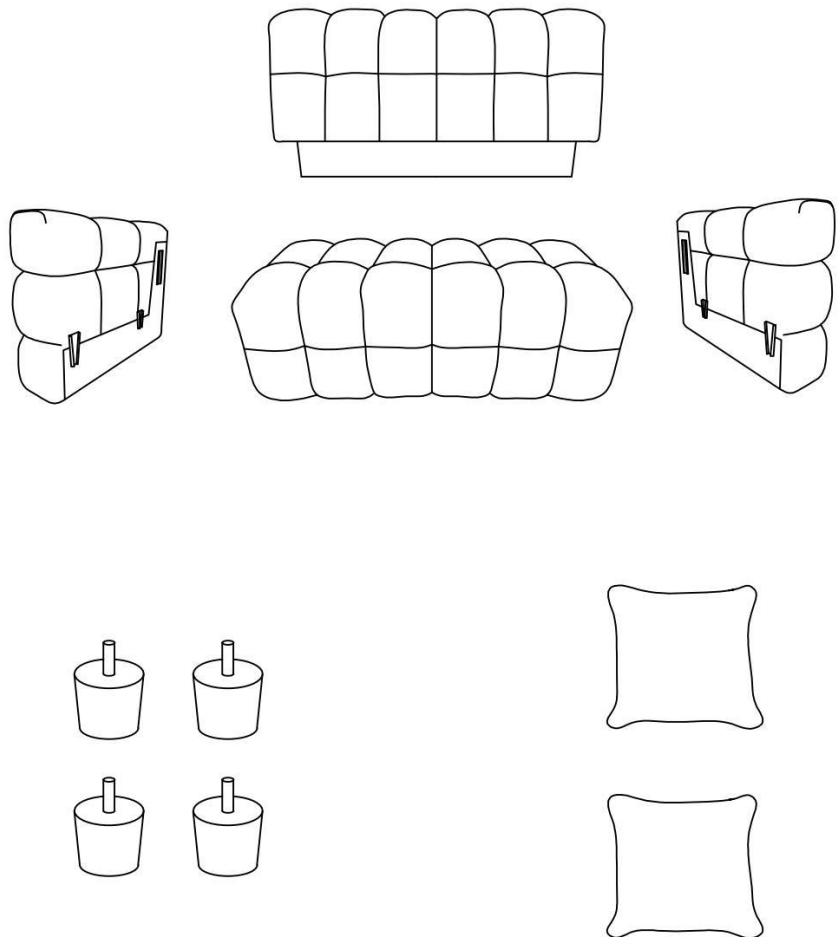

● Read instructions, cover to cover.



● Have 2 adults on hand for assembly.



● Do not assemble on flooring or carpet.



● Assemble on a clean non-marring surface (packing foam).



● Save all packaging until finished.

Step1

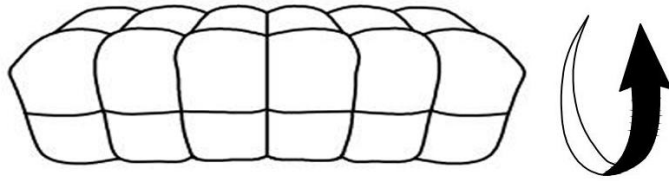

Turn the Seat over to face the bottom.

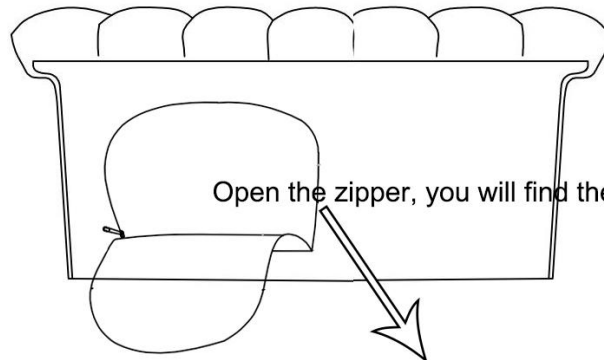

Open the zipper, you will find the sofa legs and pillows.

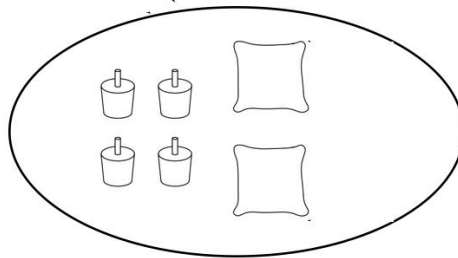

Step2

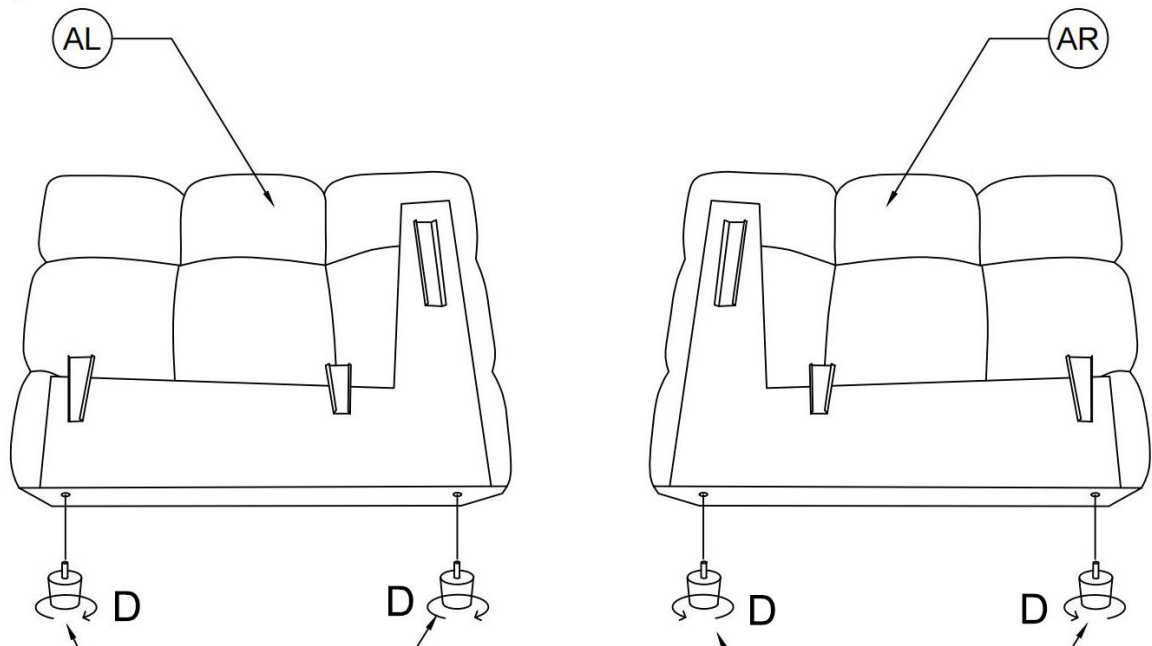

Rotate and screw the sofa feet into the pre-built screw holes in the armrests.

Step3

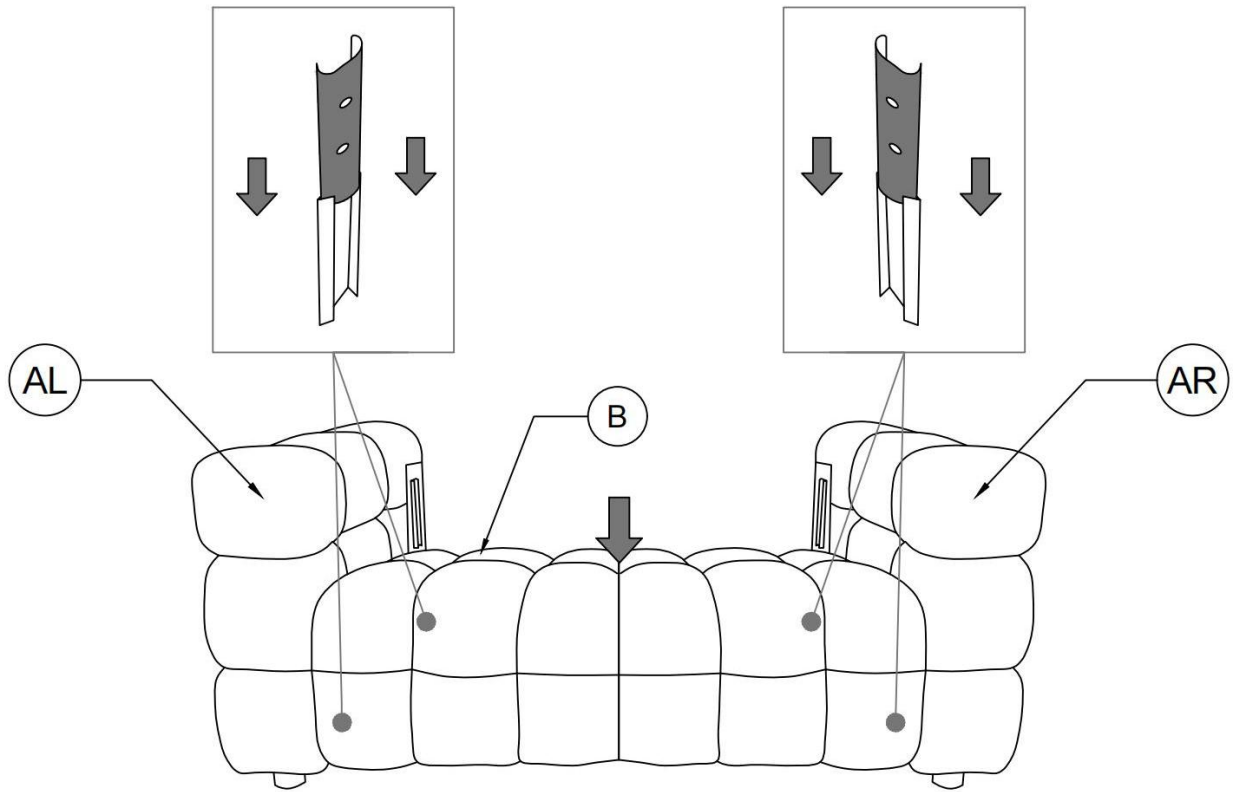

Step4

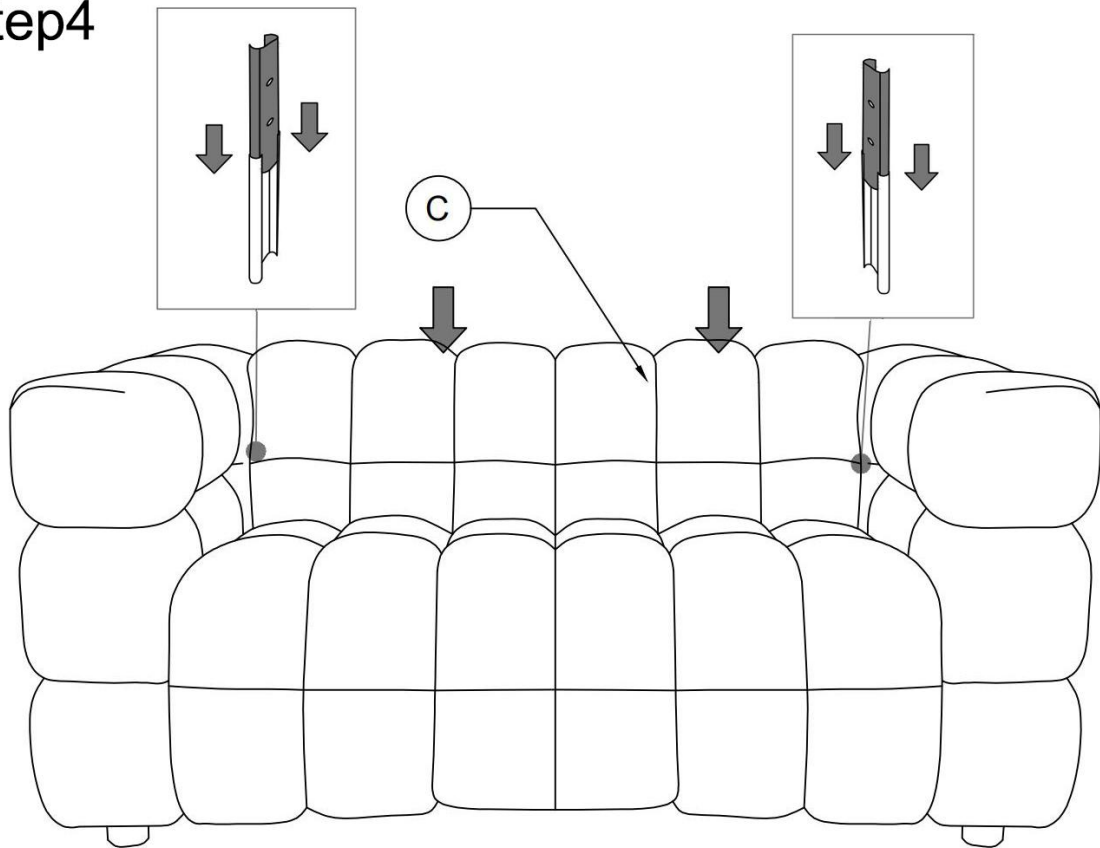

Step5

