

ASSEMBLY INSTRUCTION

PART LIST

① HEAD BOARD

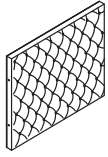

1PC

② FOOTBOARD

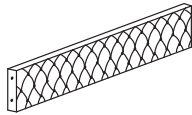

1PC

③ SIDE RAIL

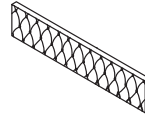

2PCS

④ HB POST (L+R)

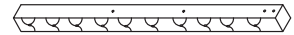

2PCS

⑤ FB POST (L+R)

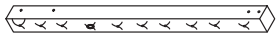

2PCS

⑥ LONG CANOPY

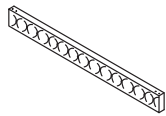

2PCS

⑦ SHORT CANOPY

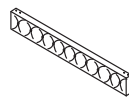

2PCS

⑧ SLAT

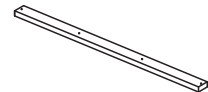

4PCS

⑨ SUPPORT LEG

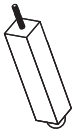

8PCS

⑩ FEET



10PCS

HARDWARE LIST

Ⓐ SCREW M4X38MM



8PCS

Ⓑ THREADED STUD
Ø5/16" X 3-1/8"



32PCS

Ⓒ FLAT WASHER
Ø5/16" X 22MM



32PCS

Ⓓ LOCK WASHER
Ø5/16"



32PCS

Ⓔ HEX NUT
Ø5/16"X12MM















32PCS

Ⓕ WRENCH 12MM

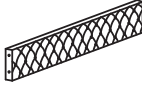

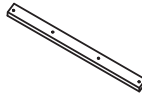
1PC

Packed in 3 cases

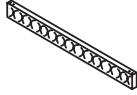
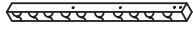
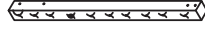
Carton	Disignation	Part		Q.TY	Hardware
1	Headboard	#1		1PC	#A  8 PCS #B  32 PCS #C  32 PCS #D  32 PCS #E  32 PCS #F  1 PC
	Footboard	#2		1PC	
	Short Canopy	#7		2PCS	
	Slat	#8		4PCS	
	Support leg	#9		8PCS	
	Feet	#10		10PCS	
2	Side Rail	#3		2PCS	
	Long Canopy	#6		2PCS	
3	HB Post	#4		2PCS	
	FB Post	#5		2PCS	

STEP 1

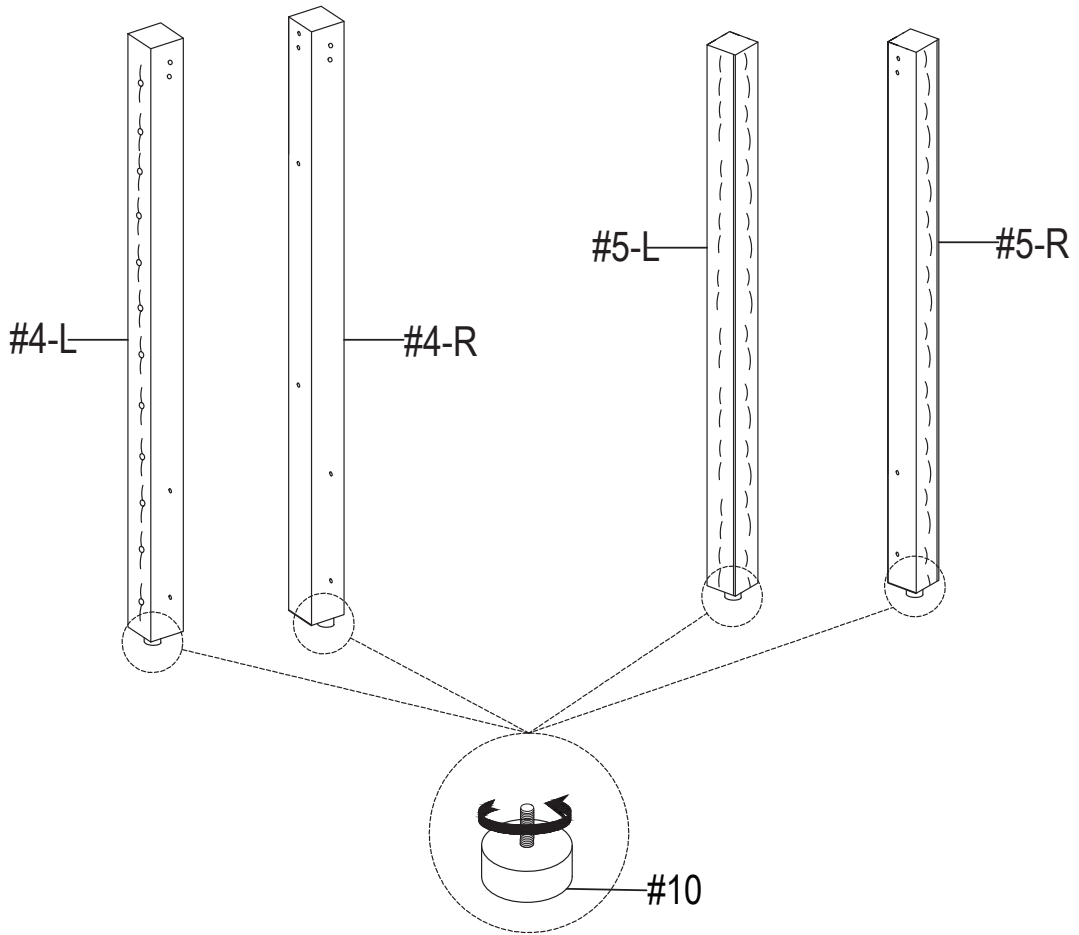

STEP 2

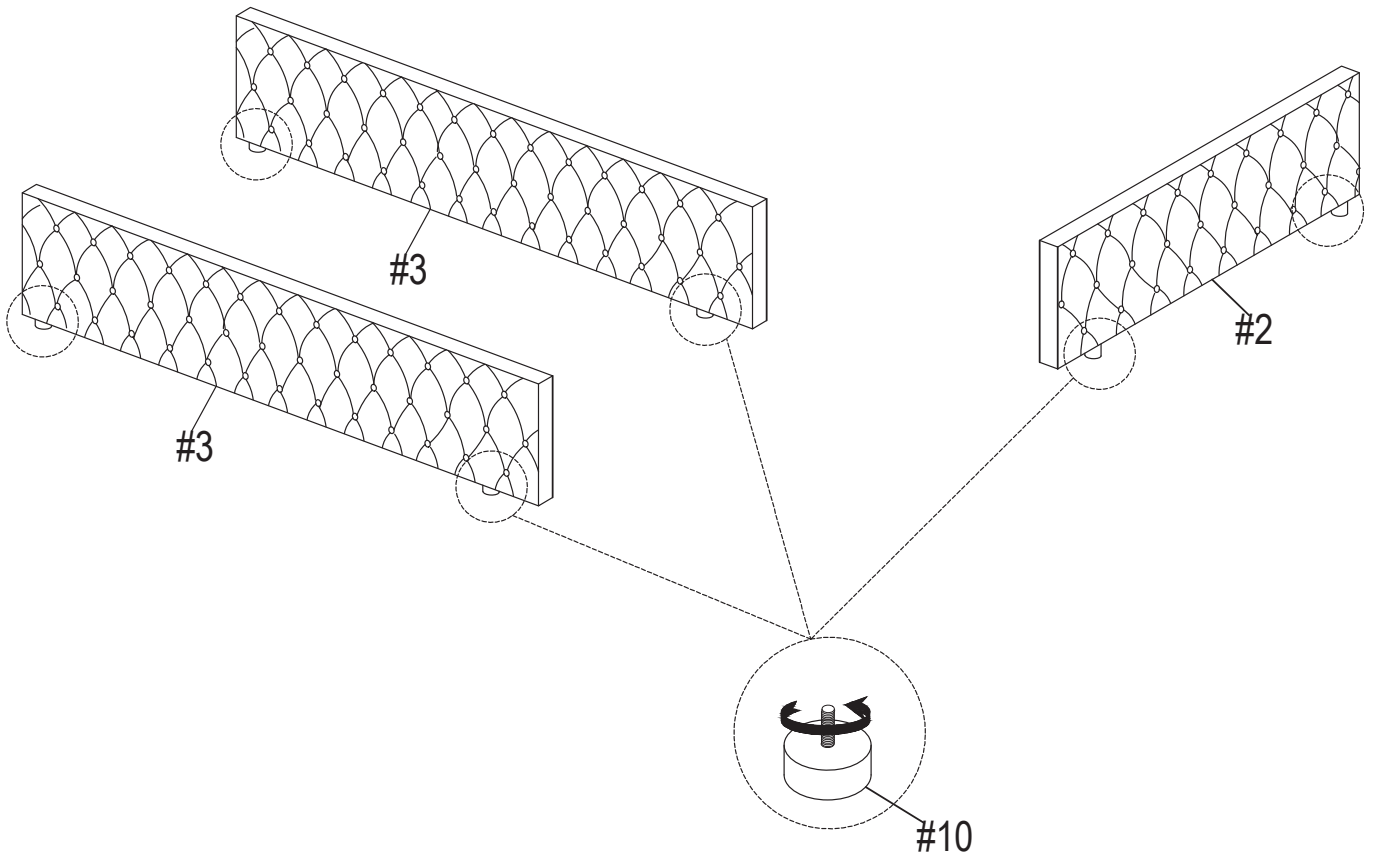

STEP 3

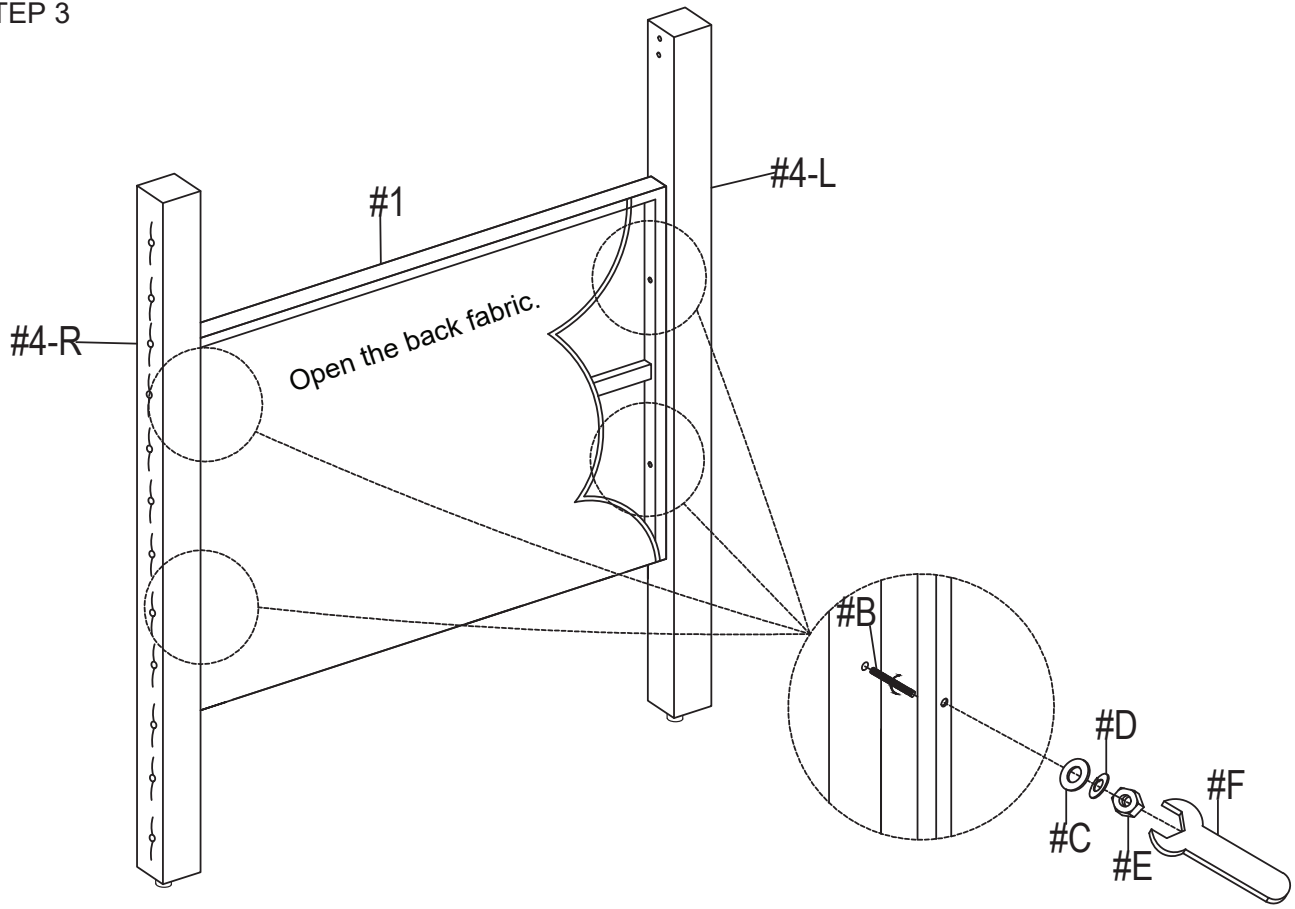

STEP 4

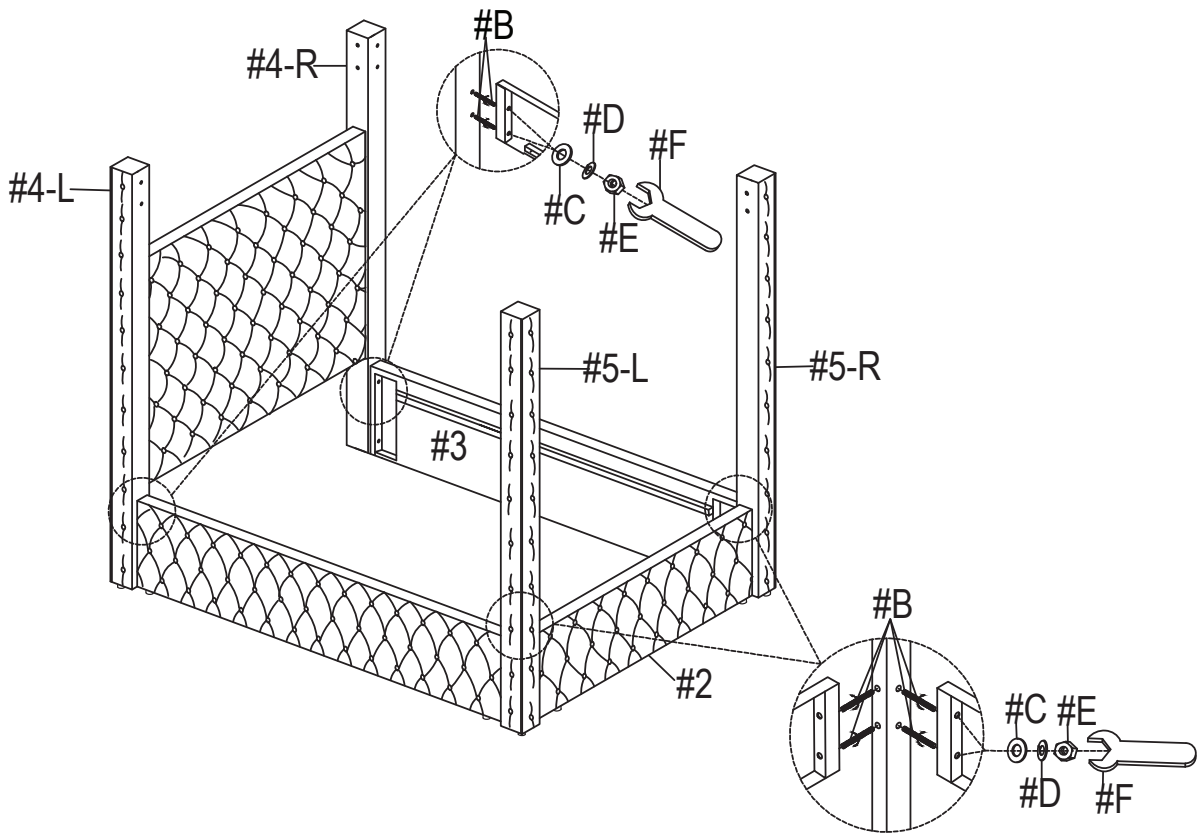

STEP 5

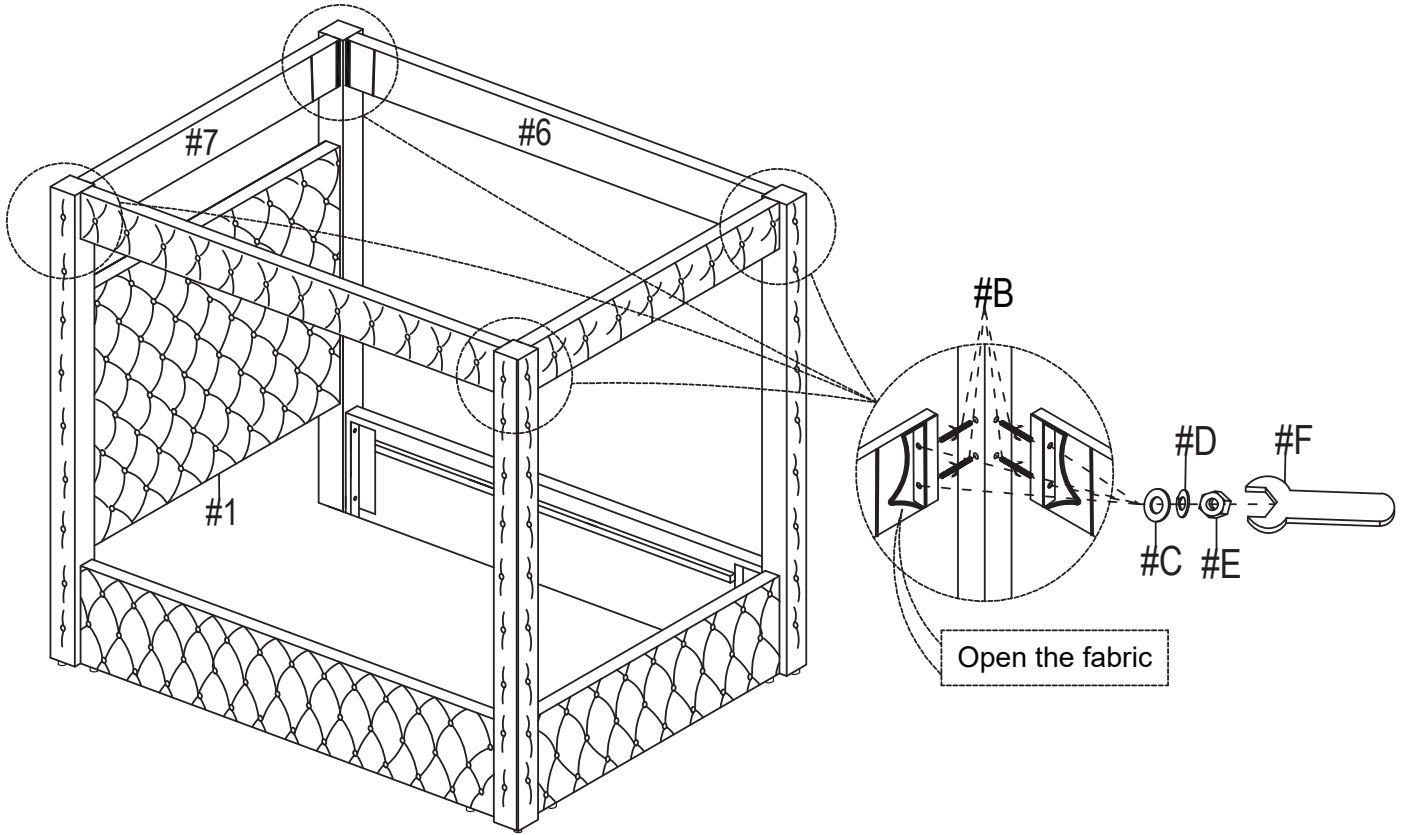

STEP 6

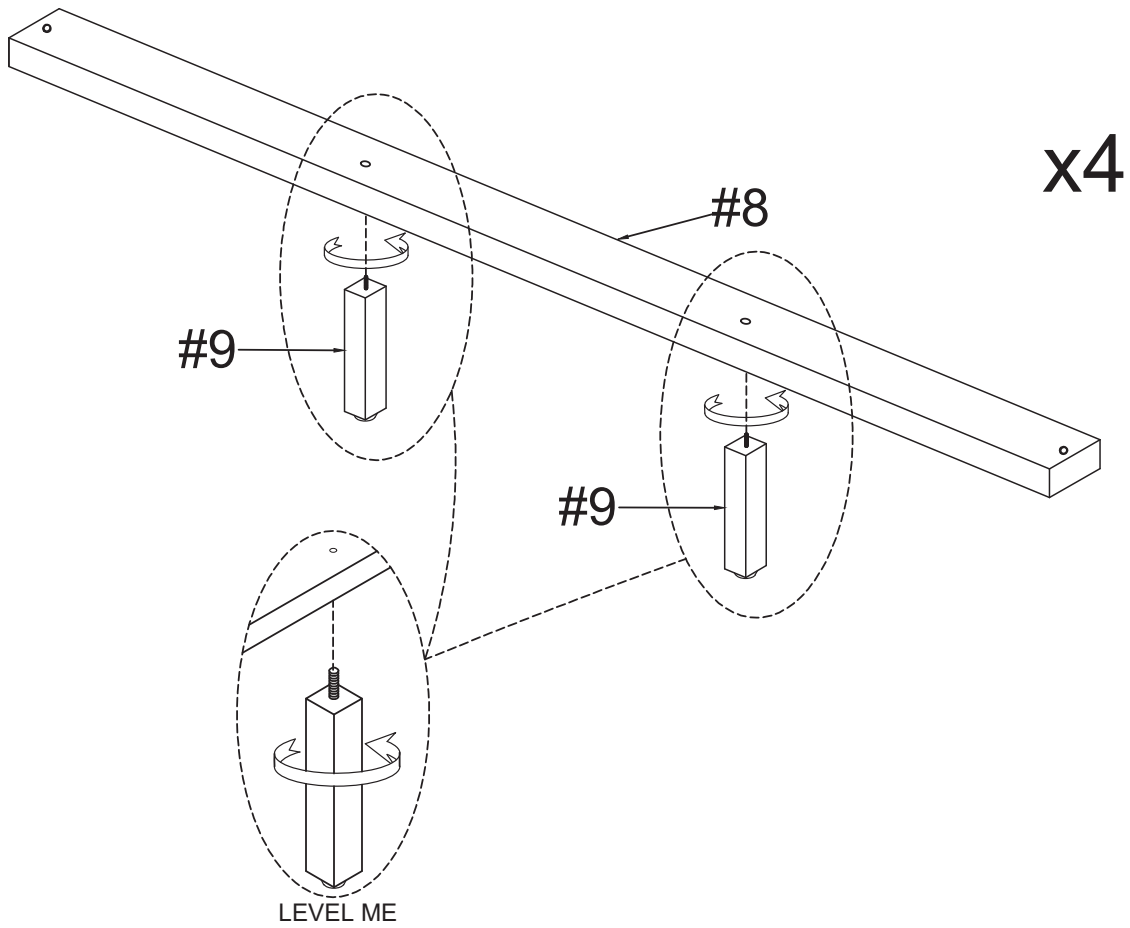

STEP 7

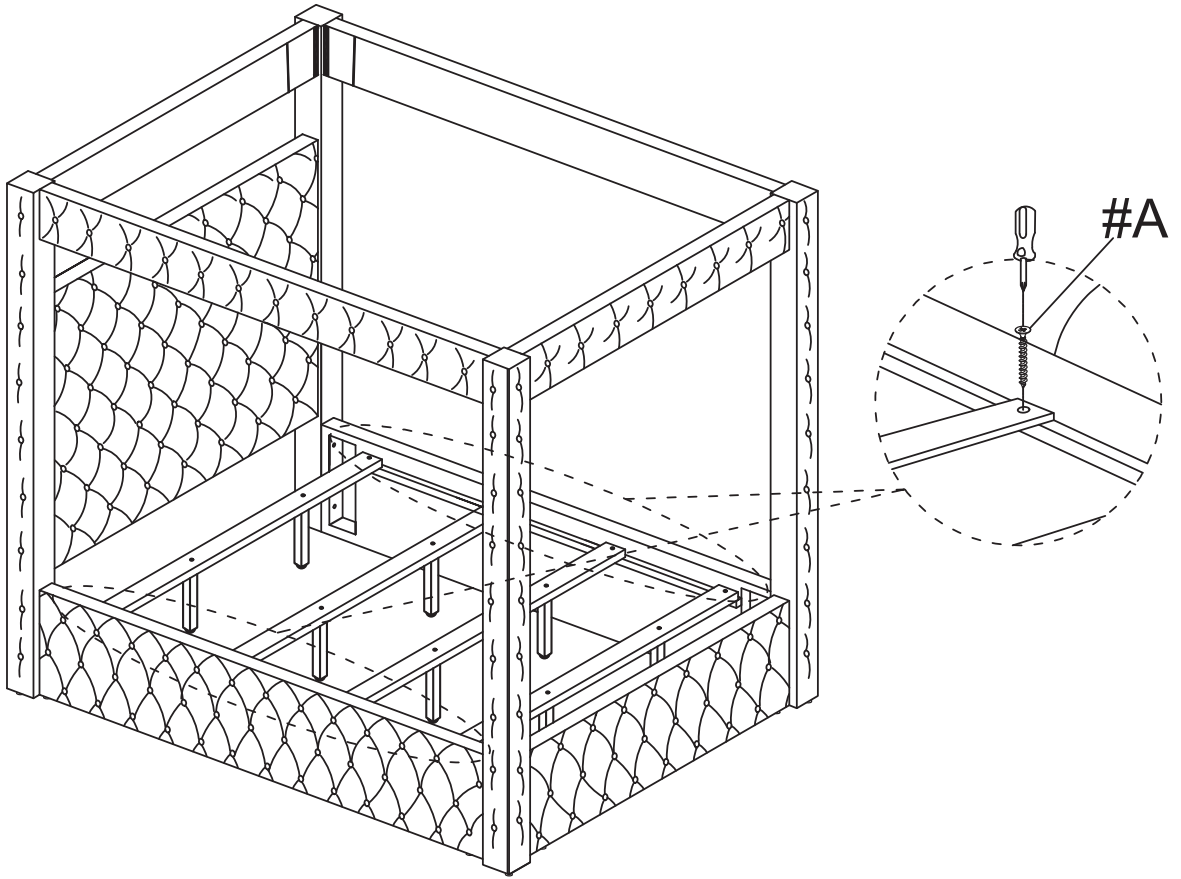

STEP 8

Assembly complete

