

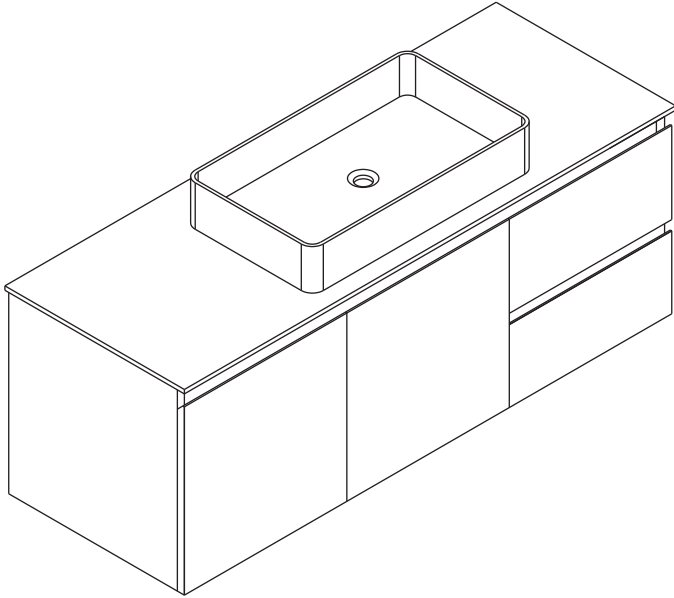

ASSEMBLY INSTRUCTIONS

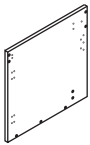

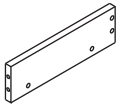

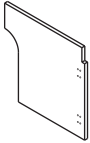
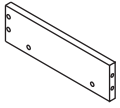
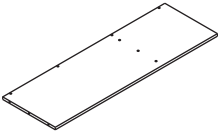
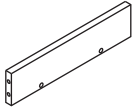
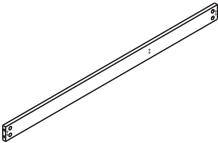
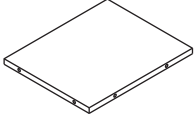
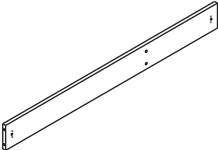
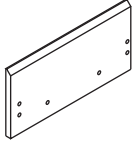
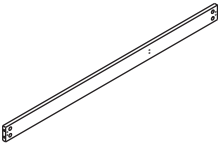
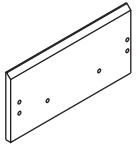

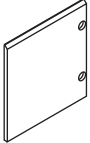
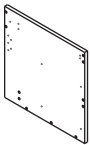
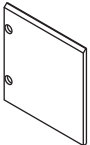

Bathroom Vanity

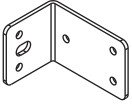
ASSEMBLY INSTRUCTIONS

1		x1	9		x2
2		x1	10		x2
3		x1	11		x2
4		x1	12		x2
5		x1	13		x1
6		x1	14		x1
7		x1	15		x1
8		x1	16		x1

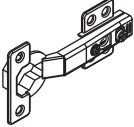
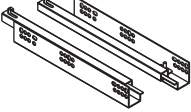
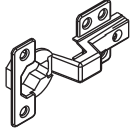
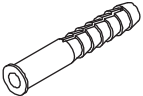
ASSEMBLY INSTRUCTIONS

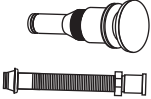
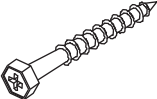
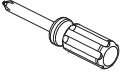
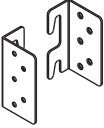
<p>Ⓐ</p>	 $\varnothing 6 \times 26 \text{mm}$	<p>x63</p>	<p>Ⓘ</p>	 	<p>x2</p>
<p>Ⓑ</p>	 $\varnothing 15 \times 9 \text{mm}$	<p>x63</p>	<p>Ⓙ</p>	 	<p>x3</p>
<p>Ⓒ</p>	 $\varnothing 3.5 \times 14 \text{mm}$	<p>x72</p>	<p>Ⓚ</p>	 	<p>x2</p>
<p>Ⓓ</p>	 	<p>x2 pcs</p>	<p>Ⓛ</p>	 	<p>x2</p>
<p>Ⓔ</p>	 	<p>x4</p>	<p>Ⓜ</p>	 	<p>x8</p>
<p>Ⓕ</p>	 	<p>x4 pcs</p>	<p>Ⓝ</p>	 	<p>x1</p>
<p>Ⓖ</p>	 	<p>x4</p>	<p>Ⓞ</p>	 	<p>x1</p>
<p>Ⓗ</p>	 	<p>x1 pcs</p>			

ASSEMBLY INSTRUCTIONS

Use the Cam Lock and Eccentric Wheel

ECCENTRIC WHEEL

Tighten the bolt until the shoulder is aligned with the panel.
Be sure not to tighten too much or too little.

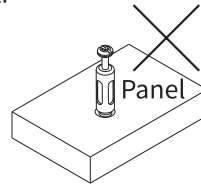
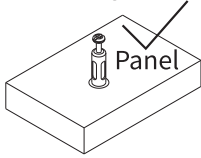

The pre-inserted nut should align with the center of the cam lock when joining two panels. The cam lock should be inserted before the eccentric wheel.

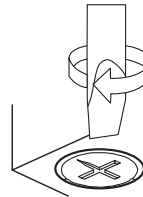
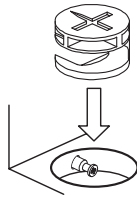

Turn the cam lock clockwise to tighten

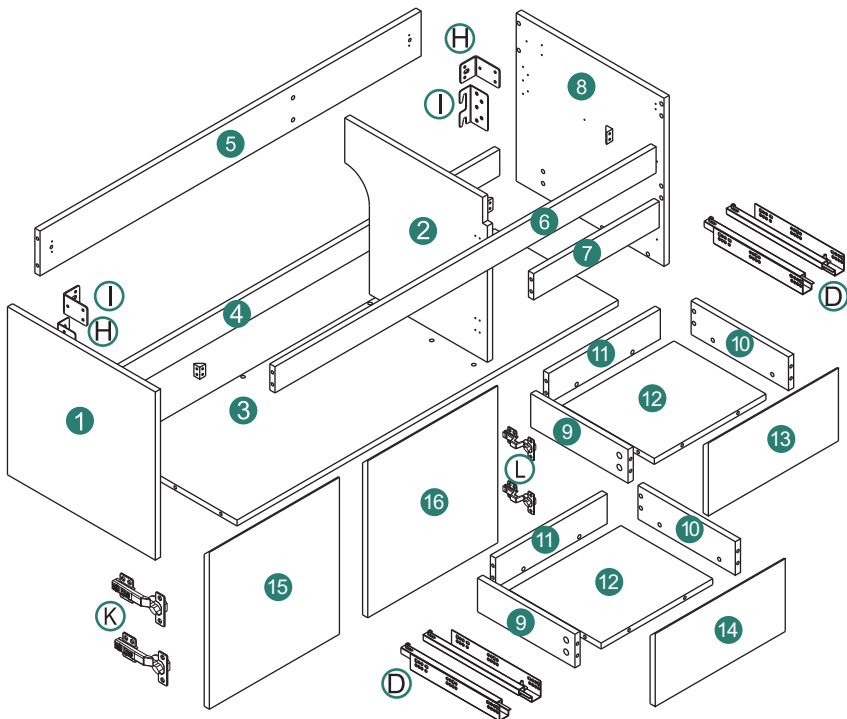

ASSEMBLY INSTRUCTIONS

1

A 63pcs B 31pcs

The floor needs to be covered with paper or carpet protective material before installation!

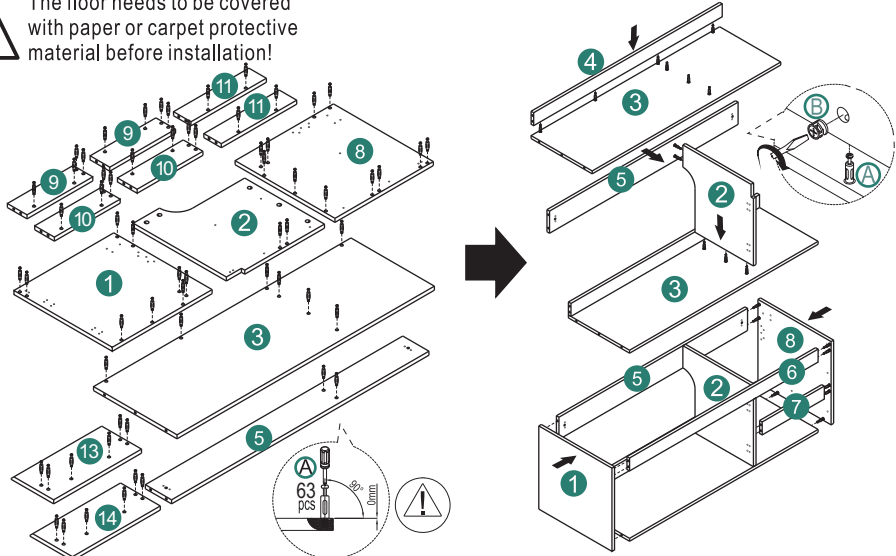

2

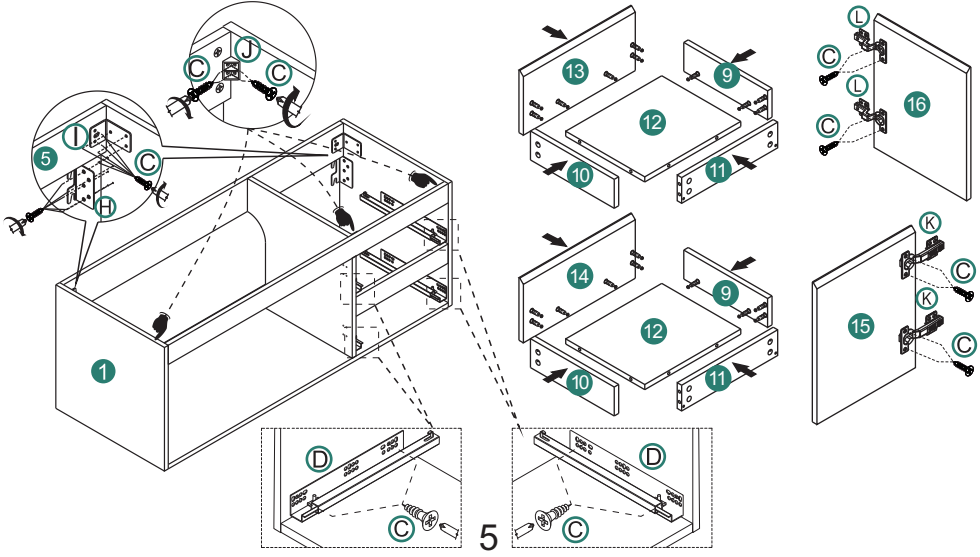

ASSEMBLY INSTRUCTIONS

3



C 16pcs



E 4pcs



Bring your own tools

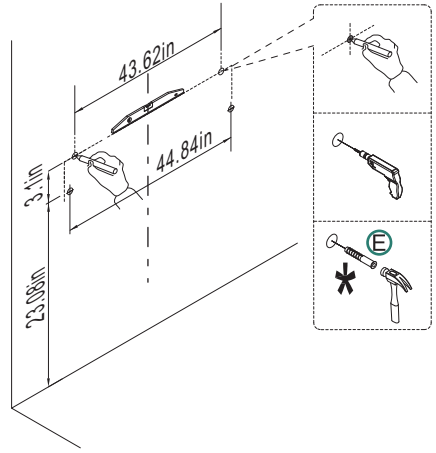
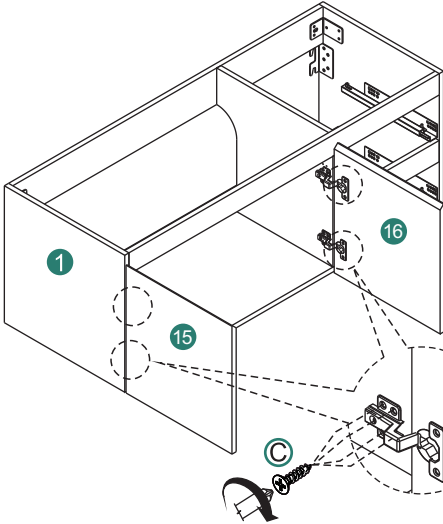

4



C 8pcs



F 4pcs



G 4pcs



M 8pcs

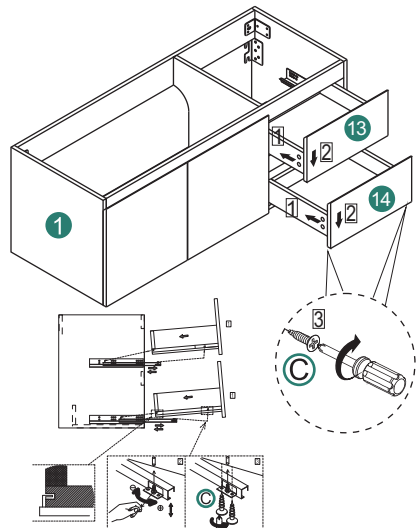
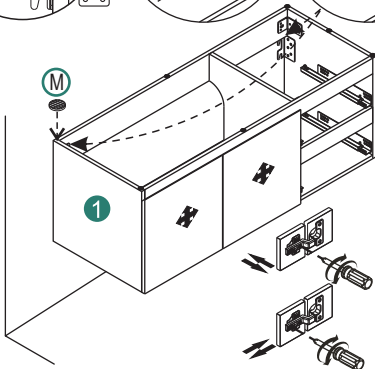
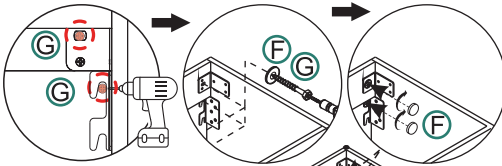

PIVOT-PRO side adjustment

Side adjustment of the door is made by using the indicated screw.

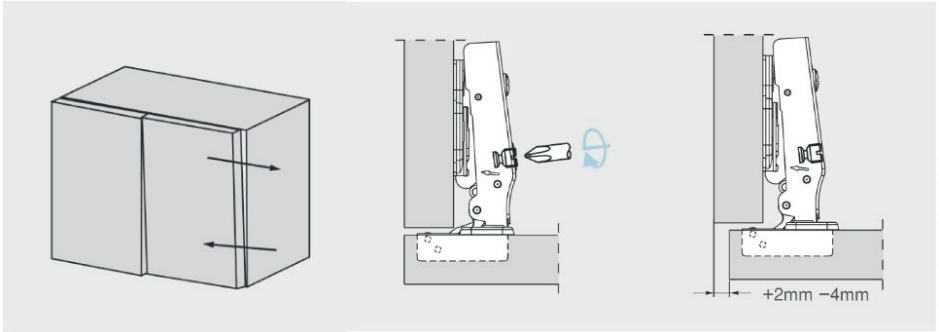

PIVOT-PRO Depth Adjustment

Depth adjustment is made without loosening any screw. The door can be moved in or out by rotating the cam adjuster on the hinge arm.

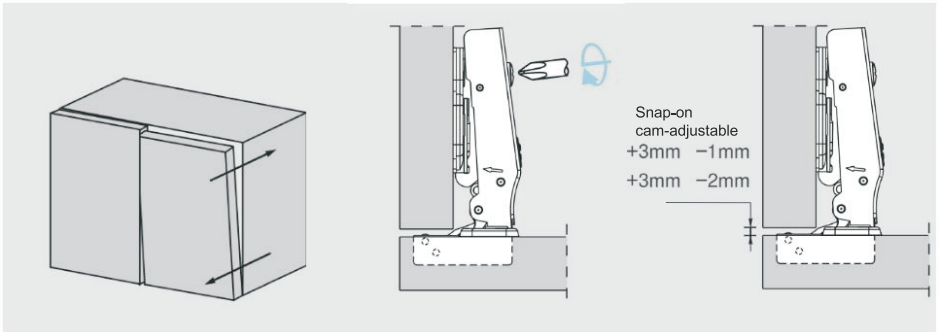

PIVOT-PRO Height Adjustment

By loosening the two fixing screws to allow the mounting plate to slide up or down, the door can be adjusted vertically by $\pm 2\text{mm}$. After retightening the screws, the Depth adjustment is done.

