

CARE AND MAINTENANCE

Store outdoor furniture indoors or cover well when not in use.

Remove wooden furniture from standing water. Dust regularly with small brush or vacuum

Spills should be taken care of immediately before they harden or stain with a slightly dampened sponge.













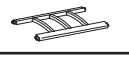

NOTICE

* Please make sure that you have all parts indicated before you begin assembly of this item

* This item should be assembled on a soft surface to prevent scratching the finish during assembly

* This item may require periodic tightening

Part List and Hardware List

PIECE	DESCRIPTION	PICTURE	QUANTITY
A	Top tray		1X
B	Bottom		1X
C	Long legs		2X
D	short legs		2X
E	Cross bar of leg - 1		3X
H1	Cross bar of leg -2		2X
H2	Cross bar of leg -3		1X
H3	Cross bar of leg -4		1X
H4	Wheel		2X
H5	Screw -1	 6x60mm	14X
H6	Screw -1	 6x35mm	4X
H7	Allen bolt L	 6x30mm	2X
H8	Washer		2X
H9	Allen key	 x2 x1	

Product Dimensions: 25.19" W x 34.25" D x 34.25" H



PREPARATION

Before beginning assembly of product, make sure all parts are present. Compare parts with package contents list and hardware contents list. If any part is missing or damaged, do not attempt to assemble the product.

Estimated Assembly Time: 10 minutes.

Tools Required for Assembly (included): Allen Key

1

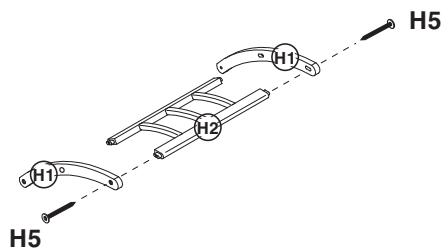

2

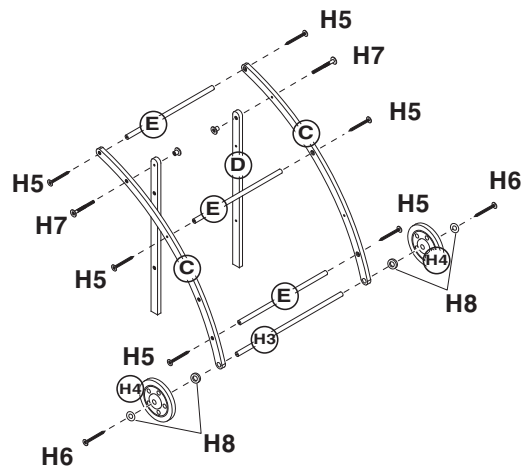

3

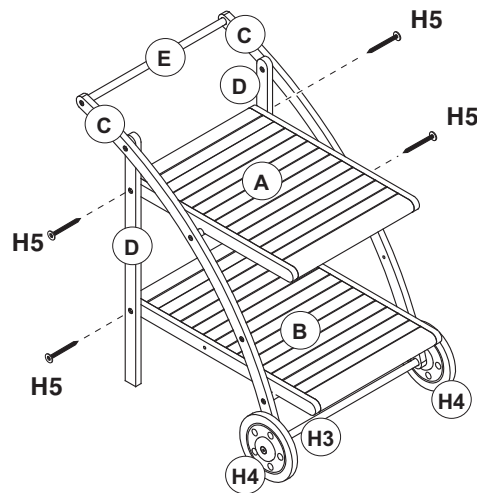

4

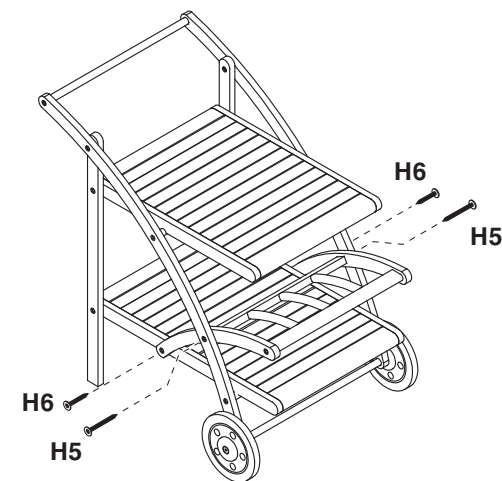

Step 1

(H1) to attach (H2). Using (H5) tighten by (H9).

Step 2

Attach (C) and (E),(H3) by used (H5), put wheel attached by use(H8) and (H6).

Step 3

Put (A) and (B) attached by used (H5).

Step 4

Use (H5) and (H6) to complete.