

NES100 Series

Corded stick vacuum cleaner; household type

Owner's Guide

Thank you for purchasing your new Eureka vacuum!

Important instructions

For easy assembly, please take a few moments to read this owner's guide.

If you have questions about your new vacuum, please contact our customer service HELPLINE at 1-800-282-2886.

We're here to help!



Eureka stands by our Clean Promise seal.

Learn more at

www.eureka.com/cleanpromise

www.eureka.com

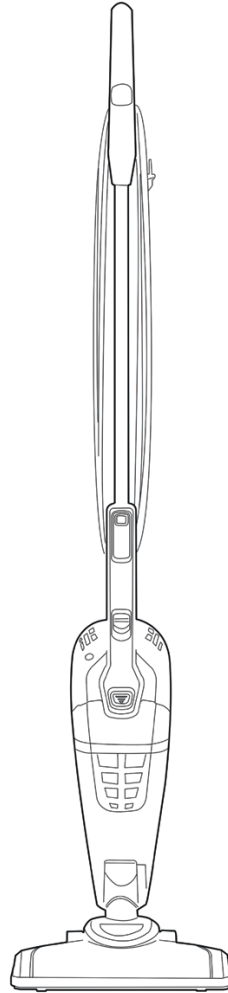

eureka

IMPORTANT SAFETY INSTRUCTION

SAFETY GUIDELINES - DEFINITIONS

It is important for you to read and understand this manual.

The information it contains relates to protecting YOUR SAFETY and PREVENTING PROBLEMS. The symbols below are used to help you recognize this information.

⚠ DANGER: Indicates an imminently hazardous situation which, if not avoided, will result in death or serious injury.

⚠ WARNING: To avoid all risks of fire, electrocution or injury, when using an electrical appliance, make sure you follow the safety measure below:

READ CAREFULLY ALL THE RECOMMENDATIONS BEFORE USING YOUR VACUUM CLEANER

⚠ CAUTION: Indicates a potentially hazardous situation which, if not avoided, may result in minor or moderate injury.

NOTICE: Used without the safety alert symbol indicates potentially hazardous situation which, if not avoided, may result in property damage.

When using an electrical appliance, basic precautions should always be followed, including the following:

READ ALL INSTRUCTIONS BEFORE USING THE APPLIANCE.

⚠ WARNING: Before using this appliance, read and follow all warnings and instructions in this manual, even if you are familiar with this product.

This appliance is not intended for use by persons (including children) with reduced physical, sensory or mental capabilities, or lack of experience and knowledge, unless they have been given supervision or instruction concerning use of the appliance by a person responsible for their safety. Young children should be supervised to ensure that they do not play with the appliance.

POLARIZATION INSTRUCTION

To reduce the risk of electric shock, this appliance has a polarized plug (one blade is wider than the other). This plug will fit in a polarized outlet only one way. If the plug does not fit fully in the outlet, reverse the plug. If it still does not fit, contact a qualified electrician to install the proper outlet. Do not change the plug in any way.

Safety Direction

Please read this instruction manual carefully before first use. It is advisable to keep this instruction manual for future reference.

DO NOT vacuum water, wet objects, liquids, ashes, hot coals, cigarette butts, matches or any hot, smoking or burning objects, etc.

DO NOT pick up flammable or combustible materials (i.e. lighter fluid, petrol, kerosene, etc.) or use in the presence of explosive liquids or vapor.

DO NOT pick up toxic material (i.e. chlorine bleach, ammonia, drain cleaner, etc.)

DO NOT vacuum Toner (for laser printer, copy machines etc.) as there is a risk of fire and explosion.

DO NOT vacuum plaster, cement etc. as the filter can become blocked.

DO NOT use vacuum without all the filters fitted.

DO NOT store or use the appliance near high temperature areas.

DO NOT run over the power cord with the vacuum cleaner.

DO NOT use vacuum cleaner if it is blocked. Turn off and clear all blockages before continuing.

DO NOT use vacuum cleaner with blocked filters. Clean or replace filters before continuing. (refer to User Maintenance section).

DO NOT use vacuum cleaner if the appliance malfunctions, sounds abnormal, smells, smokes, is dropped or damaged in any manner or any breakage is found during operation.

DO NOT misuse the cord. Never pull the appliance by the cord or pull to disconnect it from the outlet. Instead, grasp the plug and pull to disconnect.

DO NOT use vacuum cleaner to pick up large, hard, or sharp objects such as glass, nails, screws, coins, etc. that are likely to cause damage.

DO NOT leave unattended when plugged in and/or switched on.

DO NOT use vacuum cleaner if it has been dropped, damaged, left outdoors, or dropped into liquid (water etc.)

DO NOT close door on cord, or pull cord around sharp edges or corners.

DO NOT handle the plug or vacuum cleaner with wet hands.

DO NOT put any objects into openings.

DO NOT use with any openings blocked and do not restrict airflow.

DO NOT operate the appliance with a damaged cord or plug. If the supply cord is damaged, it must be replaced by the manufacturer, its service agent or similarly qualified persons in order to avoid a hazard.

DO NOT use without filters in place.

DO NOT attempt to modify this product in any way.

DO empty the dust cup and clean the filters regularly for optimal operation of the vacuum.

DO keep hair, loose clothing, fingers, feet and body parts away from openings or moving parts.

DO disconnect the appliance from the mains supply before connecting the flexible suction hose.

DO turn off controls before you connect or disconnect the appliance to or from the mains supply.

DO disconnect the appliance from the power supply when not in use, before changing the filters, cleaning the filters or connecting/disconnecting the accessories.

DO use only on dry, indoor surfaces.

DO use only as described in this manual. Use only manufacturer's recommended attachments.

DO keep cord away from heated surfaces.

DO keep all openings free of dust, lint, hair, and anything that may reduce airflow.

DO use extra care when vacuuming on stairs.

DO keep your work area well lit.

DO store your appliance indoors in a cool, dry area.

DO ensure children and babies cannot play with plastic bags or any packaging materials.

DO operate the appliance from a power source of the same voltage, frequency and rating as indicated on the product identification plate.

If this appliance is used by a third party,

DO supply the instruction manual with it. No liability can be accepted for any damage caused by non-compliance with these instructions or any other improper use or mishandling of appliance. This product has not been designed for any uses other than those specified in this manual.

DO NOT modify the polarized plug to fit a non-polarized outlet or extension cord.

Keep appliance on a level surface.





ONLY for domestic use.

Industrial or commercial use invalidates the warranty.

IMPORTANT SAFETY INSTRUCTION CONT.

READ AND SAVE THESE INSTRUCTIONS

Symbols

- The labels on your tool may include the following symbols. The symbols and their definitions are as follows:
Vvolts
A amperes
Hzhertz
Wwatts
minminutes
 \sim or ACalternating current
 --- or DC.....direct current
n_o.....no load speed
 Class I Construction
earthing terminal (grounded)
safety alert symbol
 Class II Construction (double insulated)
.../min or rpm.....revolutions or reciprocations per minute

- When using an extension cord, be sure to use one heavy enough to carry the current your product will draw. An undersized cord will cause a drop in line voltage resulting in loss of power and overheating.

Volts	Minimum Gauge for Cord Sets				
	Total Length of Cord in Feet				
120V	0-25	26-50	51-100	101-150	
	(0-7,6m)	(7,6-15,2m)	(15,2-30,4m)	(30,4-45,7m)	
240V	0-50	51-100	101-200	201-300	
	(0-15,2m)	(15,2-30,4m)	(30,4-60,9m)	(60,9-91,4m)	
Ampere Rating					
More Than	Not more Than	American Wire Gauge			
0	6	18	16	16	14
6	10	18	16	14	12
10	12	16	16	14	12
12	16	14	12	Not Recommended	

The following table shows the correct size to use depending on cord length and nameplate ampere rating. If in doubt, use the next heavier gauge. The smaller the gauge number, the heavier the cord.

Transporting your Vacuum

To move your vacuum cleaner from room to room, unplug the unit and either push the appliance or carry using the carry handle.

Never pull or carry the vacuum cleaner by its cord.

Product View

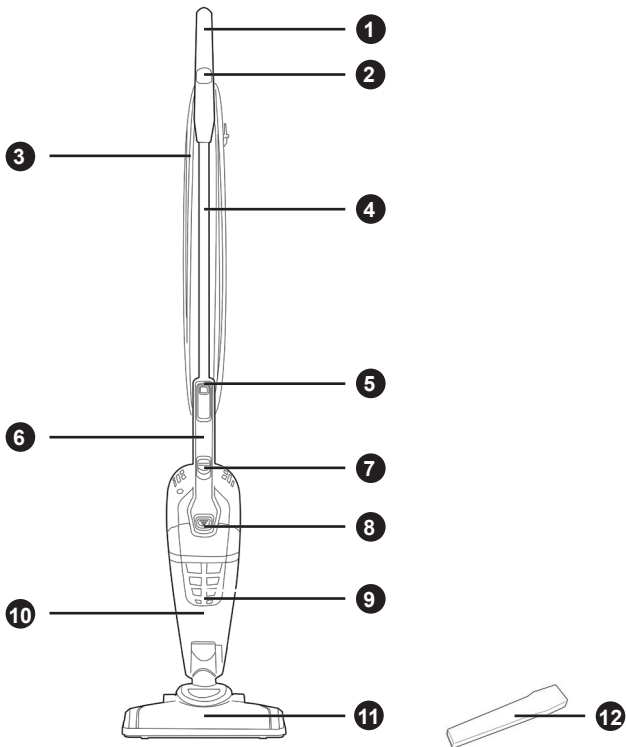

- | | |
|-------------------------|----------------------------|
| 1. Hand Grip | 8. Dust Cup Latch |
| 2. Cord Wrap | 9. Filter |
| 3. Power Cord | 10. Dust Cup |
| 4. Handle | 11. Removable Floor Nozzle |
| 5. Quick Release Button | 12. Crevice Tool |
| 6. Hand Vacuum Grip | |
| 7. Power On/Off | |

⚠ CAUTION: Do not plug in your vacuum cleaner until you are familiar with all instructions and operating procedures.

Assembly/Operation

⚠ WARNING: Do not operate cleaner with damp or wet filters or without vacuum bags and all filters in place.

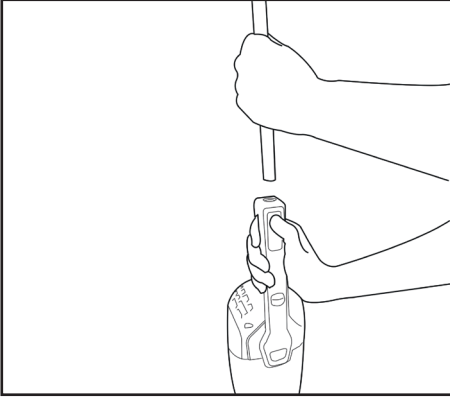

Press the quick release button at the base of the hand vacuum grip and insert the handle, making sure it is all the way inserted into the body of the vacuum.

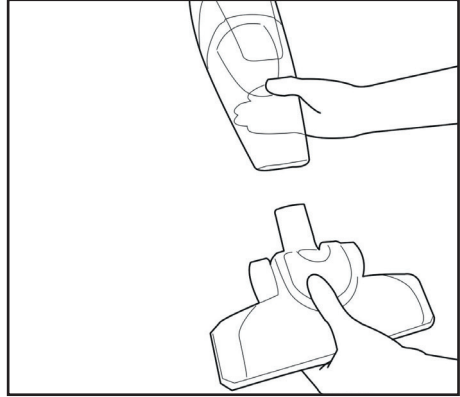

Attach the floor nozzle by inserting it into the opening at the bottom of the dust cup. Press firmly to secure in place.

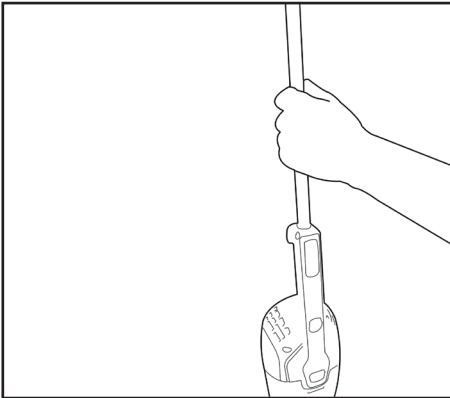

As a Hand Vacuum

Press the button at the base of the hand vacuum grip and pull the handle away from the unit.

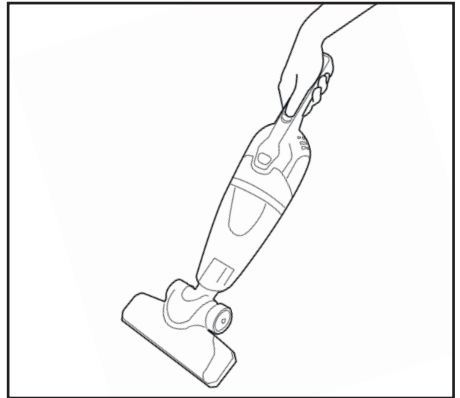

As a Multi-Purpose Vacuum:

The floor nozzle may be used with the hand vacuum to clean wider surfaces. To attach the floor nozzle to the hand vac, insert it into the opening at the bottom of the dust cup. Press firmly to secure in place.

Assembly/Operation

Power cord storage

1. Turn vacuum off (O).
2. Unplug power cord by grasping the polarized plug, NOT the cord, and disconnect from outlet.
3. Loop power cord around cord wrap on the handle.
4. Clip molded plug to power cord to secure.

⚠ WARNING: To avoid injury, turn vacuum OFF and unplug cord from wall when not in use.

Accessories

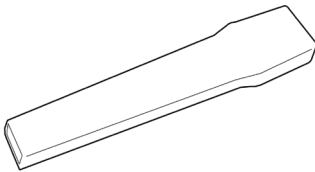

Crevice Tool

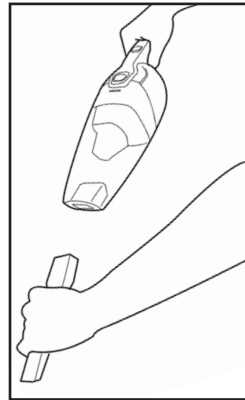

You can insert crevice tool to extend the distance.

Maintenance And Care - Emptying and Cleaning

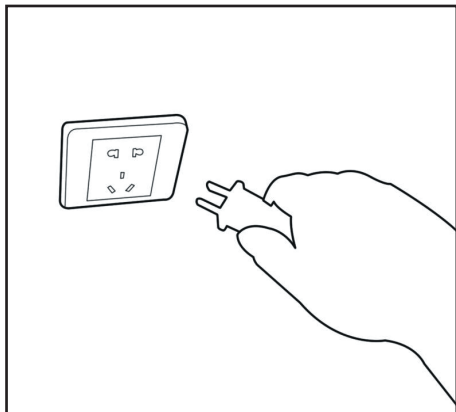

1. Turn Vacuum off (O). Then, unplug vacuum.

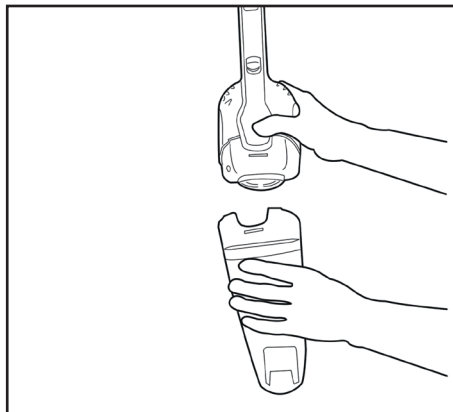

2. To remove dirt from the dust cup and filter, hold the vacuum vertically. Depress and hold button on top of the vacuum to release the dust cup as the shown.

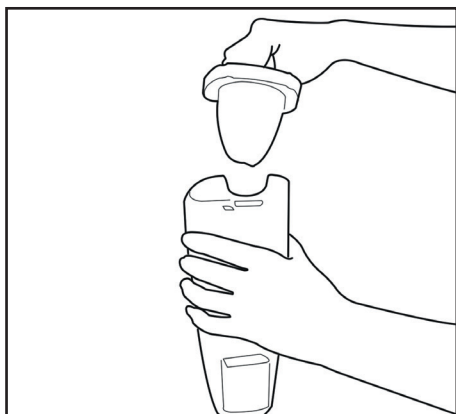

3. Gently pull dust cup away from the hand vacuum grip and remove the filter as shown. Empty into waste container.

4. The dust cup may be rinsed with warm water and a mild detergent if needed. The dust cup must be thoroughly dried before replacing.

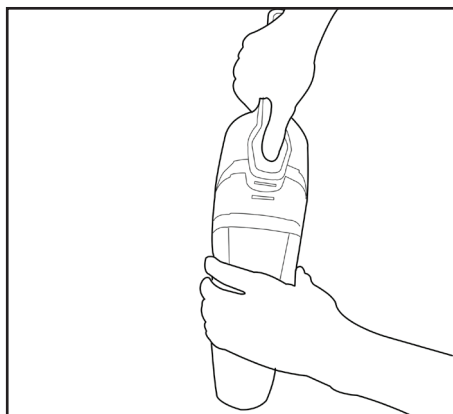

5. Replace filter. Attach dust cup to vacuum by depressing latch and securely fitting onto hand grip. Make sure dust cup is correctly secured.

Maintenance And Care - Cleaning Vacuum And Tools

DO NOT clean the vacuum cleaner, components or accessories using petroleum or any other flammable liquid or solvents, etc.

Clean only the outside of the vacuum cleaner.

Use only a moist cloth and mild detergent for cleaning the vacuum cleaner, components and accessories.

After cleaning, wipe off the moisture on vacuum cleaner, components and accessories with a dry cloth.

DO NOT place accessories, tools or components in a dishwasher.

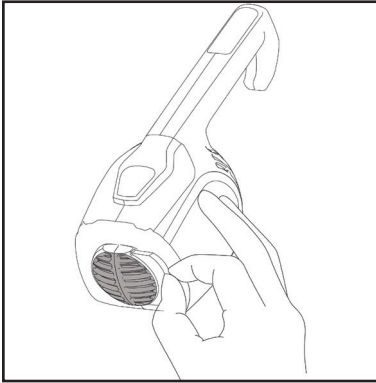

To maintain suction and cleaning performance, you can check pre-motor filters regularly, if needed, pull it out and clean with warm water and a mild detergent. The filter must be thoroughly dried before put back. Replace with black side facing out.

⚠ CAUTION: Never operate your vacuum cleaner without the filter in place. Doing so may damage the motor and void the warranty.

Troubleshooting

⚠ WARNING: To reduce the risk of electric shock, turn power OFF and disconnect plug from electrical outlet before performing maintenance or troubleshooting to the vacuum cleaner.

- | | |
|--|--|
| Vacuum cleaner won't run: Possible causes | Remedies |
| 1. Vacuum cleaner is not plugged in firmly | 1. Check electrical outlet |
| 2. Blown fuse/tripped breaker | 2. Check/replace fuse or reset breaker |

Vacuum cleaner won't vacuum effectively: Possible causes	Remedies
1. Filter clogged, wet or dirty.	1. Follow instructions for cleaning.
2. Dust cup clogged.	2. Follow instructions for emptying.
Dust blows out of air vent: Possible causes	Remedies
1. Filter not properly secured to filter frame.	1. Follow instructions for replacing filter above.

Replacement Parts

Item:	Part No.:	Part Name:
1	ST0101	Crevice Tool
2	ST0102	Filter
3	ST0106	Pre-Motor Filter

1

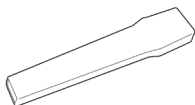

2



3



The Eureka one-year limited warranty

Midea America Corp. (“Eureka”), subject to the terms and conditions herein, warrants this vacuum cleaner to be free from defects in material and workmanship for a term of one year from the date of original purchase when used in accordance with the Eureka operating and maintenance instructions and under normal household usage. This warranty is granted only to the original purchaser and members of immediate household, and is applicable only to original purchases from Eureka authorized resellers.

What Eureka will do:

Eureka will, at its option, repair or replace a defective vacuum or vacuum part that is covered by this warranty. Repairs may be performed using new or refurbished parts that meet or exceed Eureka specifications for new parts. If Eureka elects to replace the vacuum, the replacement may be a reconditioned unit. Depending on availability of products, Eureka reserves the right to provide you with a replacement product that is the same or similar, or substitute equivalent of the original product. As a matter of warranty policy, Eureka will not refund the consumer’s purchase price.

This warranty does not cover:

- Normal wear and tear of the vacuum and vacuum parts that require replacement under normal use such as disposable dust bags, filters, drive belts, light bulbs, brush-roll, bristles, impellers and cleaning.
- Damages or malfunctions resulting from: improper or unreasonable use or maintenance, abuse, negligence, failure to follow instructions contained in any written materials that accompany the product, deterioration by reason of excess moisture, corrosive atmosphere, lightning, power surges, connections to improper voltage supply, unauthorized alteration, or other external causes such as extremes in temperature or humidity, modifications, scratches or discoloration, accidents, misuse, or acts of God. This warranty also does not cover damage resulting from repair or attempted repair by anyone other than Eureka or an authorized Eureka Warranty Station. This warranty is not applicable to any product that has been altered or on which the serial number has been defaced, modified or removed. Altering, erasing, or forging any proof-of-purchase documents voids any applicable product warranty.

Obtaining warranty service:

To obtain warranty service you must contact the Eureka Service Team, toll free, at 1-800-282-2886 or email customerserviceusa@midea.com, to discuss the warranty claim and procedures to be followed. All warranty claims must include submission of proof-of-purchase documentation. For additional information, you may also visit www.eureka.com.

Shipping charges:

You will be responsible for any initial shipping and insurance charges if the defective product(s) must be shipped for warranty service or warranty evaluation; however, Eureka or a Eureka Authorized Warranty Station will pay the return shipping charges if repairs are covered by the warranty. When returning parts for repair, you must include the model, type and serial number located on the rating plate. If any product submitted for warranty service is found to be ineligible, an estimate of repair cost will be furnished and the repair performed only if requested by the owner and upon receipt of payment or acceptable arrangements for payment.

Further limitations and exclusions:

Any warranty that may be implied in connection with your purchase or use of the vacuum, including any warranty of Merchantability or any warranty of Fitness For A Particular Purpose is limited to the duration of this limited warranty. Some states do not allow limitations on how long an implied warranty lasts, so the above limitations may not apply to you.

Your relief for the breach of this warranty is limited to the relief expressly provided above. In no event shall the manufacturer be liable for any consequential or incidental damages you may incur in connection with your purchase or use of the vacuum. Some states do not allow the exclusion or limitation of incidental or consequential damages, so the above limitation or exclusion may not apply to you.

This warranty gives you specific legal rights. You may also have other rights, which may vary by state.

**Midea America Corp.
200 Rivers Edge Drive
Medford, MA. 02155
USA**