



626-679-3588
service@getprohome.com
www.getprohome.com
162 Atlantic St, Pomona, CA 91768

INSTALLATION GUIDE

CERAMIC SINK

service@getprohome.com
626 679 3588

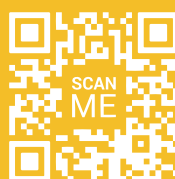

PRODUCT
INSTRUCTION
VIDEO

MODEL No.GP-BBS17-14C



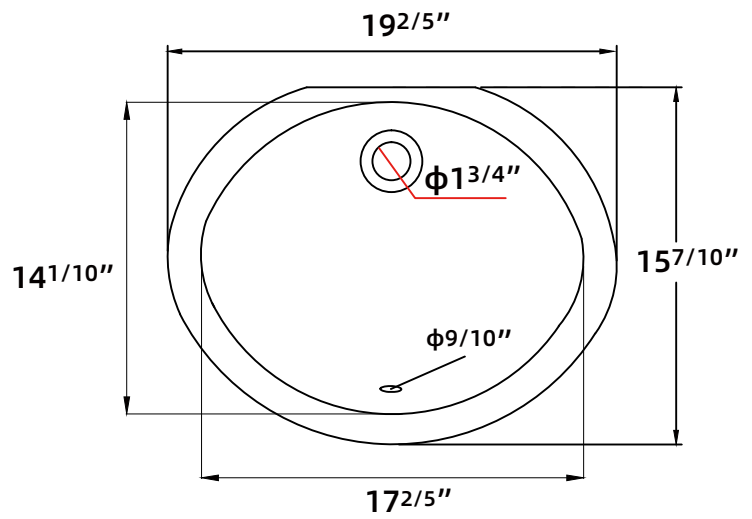

TOP VIEW

Features:

- Sleek, seamless design
- Glazed ceramic
- Integrated overflow
- Standard 1 3/4" drain hole

Installation:

- Undermount

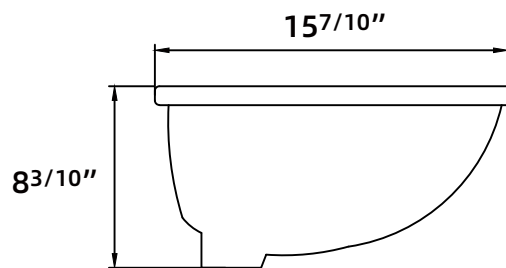

SIDE VIEW

Colors

- White

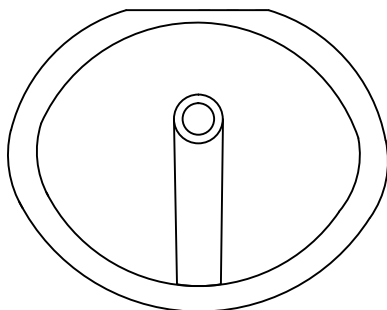

BOTTOM VIEW

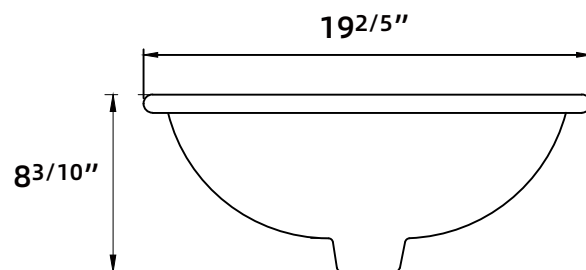

FRONT VIEW

DELUXE CERAMIC SINK COLLECTION



SKU NO.:
GP-BBS18-13S

SKU NO.:
GP-BBS18-14S

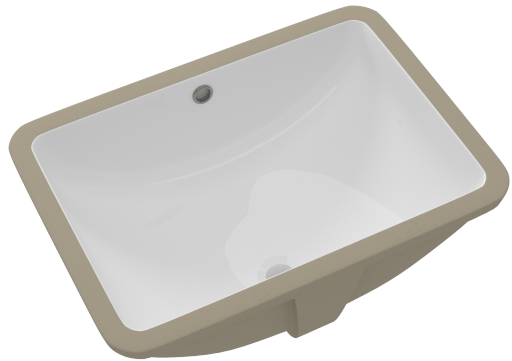

SKU NO.:
GP-BBS18-12S

DELUXE CERAMIC SINK COLLECTION



SKU NO.:
GP-BBS15-11C

SKU NO.:
GP-BBS17-14C



INSTALLATION INSTRUCTIONS

Suggested Tools and Materials:



(Clean Cloth)

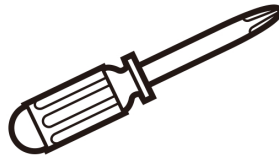

(Cross Screwdriver)

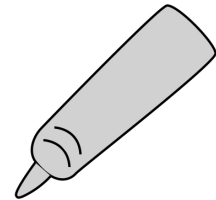

(Silicone Sealant)

Attention:

1. DO NOT use adhesives or adhesive sealants to install this sink.
2. Sink Only, and without mounting hardware.

Installation Steps:

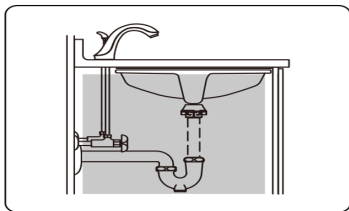

1. Verify the cabinet clearance.

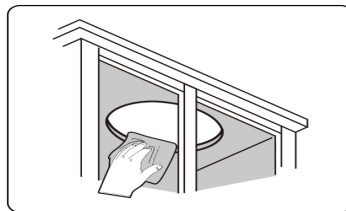

2. Clean the bottom of the countertop and the edge of the sink.

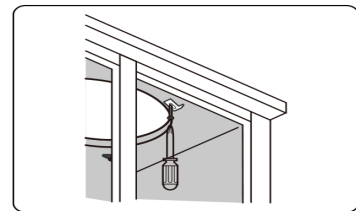

3. Install the clamp loosely.

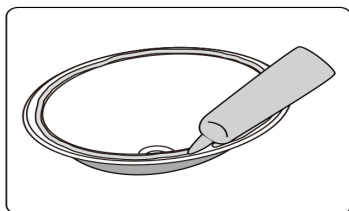

4. Plenty of enough silicone sealant around the surrounding area.

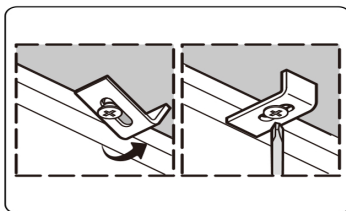

5. Position the sink under the opening. Fix the sink in place and rotate each clamp to the side. Tighten the clamp quickly to secure it.

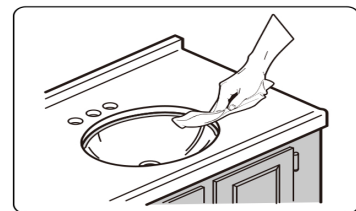

6. Wipe off the excess sealant immediately.

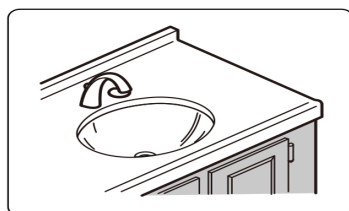

7. Complete the installation of faucet and drain.

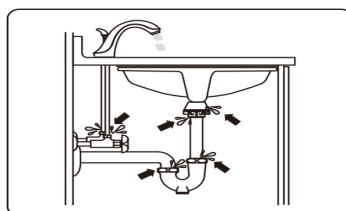

8. Check all connections for leaks when running water into the sink.

HOME SERVICES



INSTALLATION VIDEO

Missing Part or Defective?

Please Contact the Customer Service Team

✉ service@getprohome.com

☎ 626 679 3588