

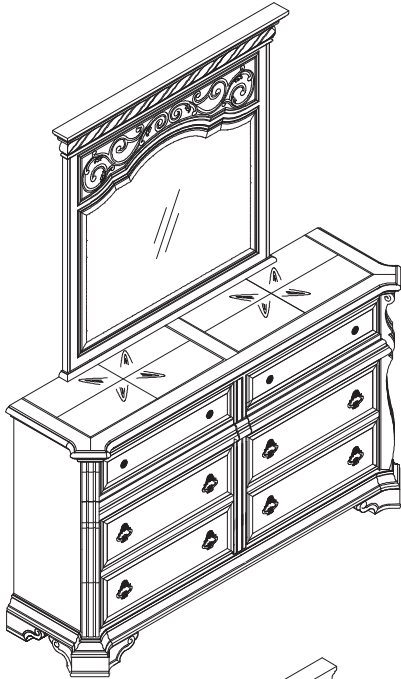

ASSEMBLY INSTRUCTION

DESCRIPTION: LANDSCAPE MIRROR 8 DRAWER DOUBLE DRESSER





Thank you for purchasing this quality product. Be sure to check all packing material carefully for small parts which may have some loose inside the carton during shipment. Identify and count all parts and compare with the parts List Below:

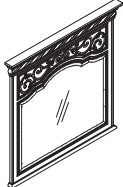

PART LIST

①		②	
DRESSER: 1PC		MIRROR : 1PC	

HARDWARE LIST

NO.	Drawing	Description	Q'ty
A		Bolt ($\Phi 1/4" \times 1-1/2"$)	2pcs
B		Bolt ($\Phi 1/4" \times 1-1/4"$)	4pcs
C		Flat washer ($\Phi 1/4" \times 19\text{mm}$)	6pc
D		Spring washer ($\Phi 1/4"$)	6pcs
E		Allen wrench (4mm)	1pc

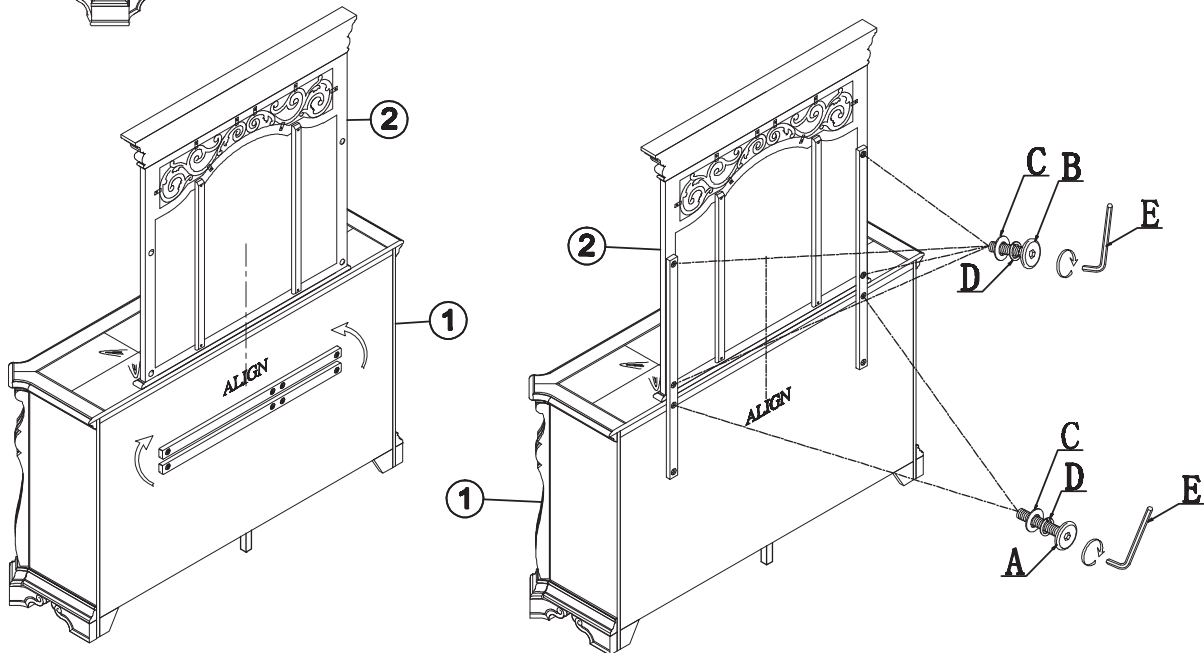

CLEANING INSTRUCTION

Clean the Dresser / Mirror surface with a furniture polish and a soft cloth.