

ITEM NUMBER: MRCF03-12

Please consult your electrician for hanging fixture and wiring.

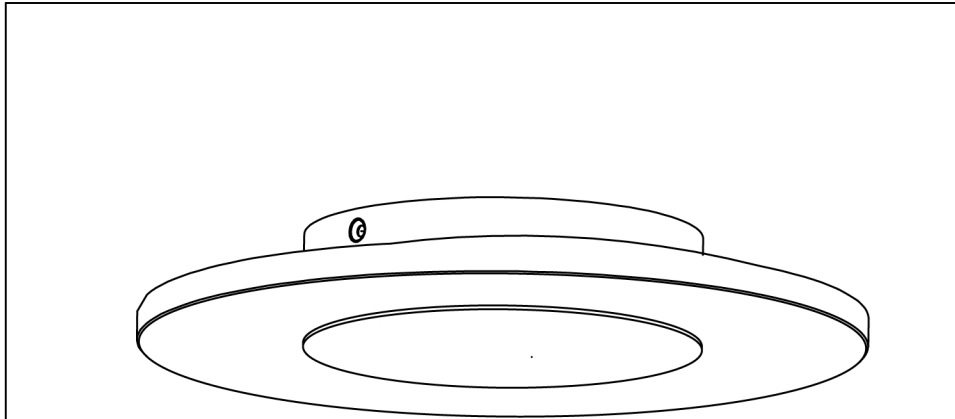

The fixture is designed to dim with a standard Triac forward phase dimmer. Dimming levels will vary by dimmer.

Below is a list of recommended dimmers:

- Lutron MACL-153M
- Lutron DVL-153P
- Lutron SCL-153P
- Leviton IPL06-10Z
- Leviton 6674-POW

Due to inrush current, wattage should not exceed 150 Watts of product for a 600W dimmer.

WARNING: Wires need to be connected to driver found in canopy and should not be connected directly to power source or a short may occur.

3000K-4000K-5000K DIMMABLE

IMPORTANT: Turn off the power at the main fuse or circuit breaker box before starting installation

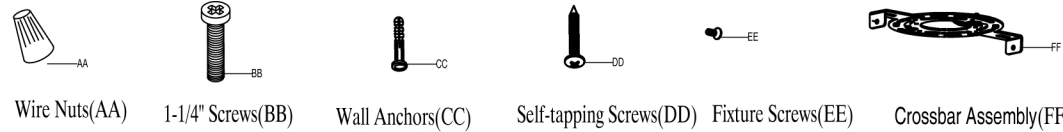

Locate all hardware & components before discarding packaging

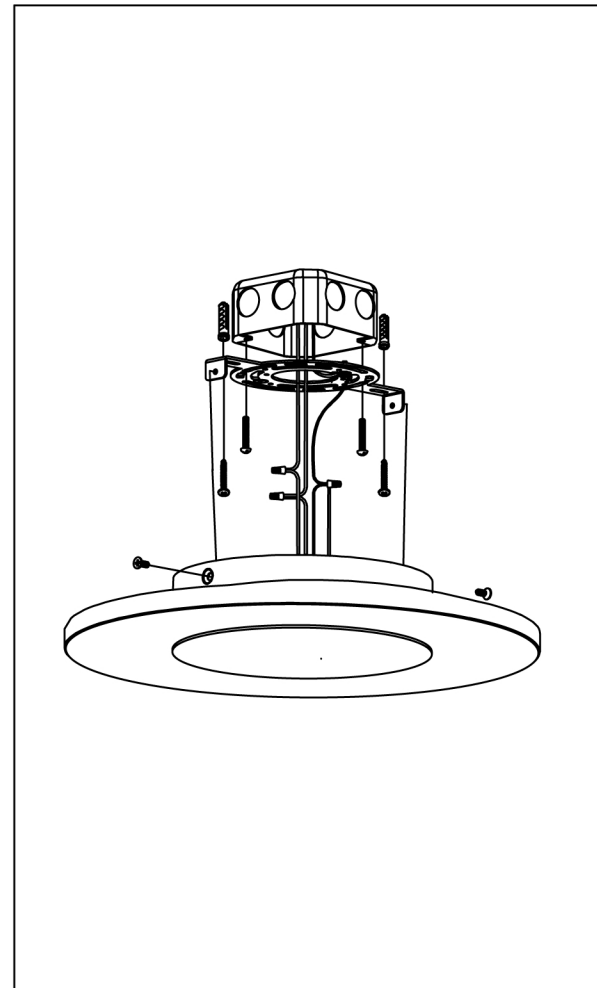

Cleaning & Care:
Clean with soft cloth and a mild detergent.
Do not use abrasive cleaner.

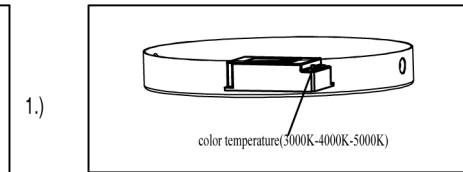

1.)

color temperature(3000K-4000K-5000K)

Step 1: Choose needed color temperature by adjusting switch position.

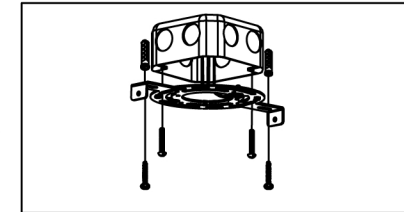

2.)

Step 2: Remove the crossbar assembly from the ceiling canopy .
Secure the crossbar assembly to the outlet box (not included) with the outlet box screws.
For drywall installations, insert the wall anchors(CC) into the holes. Otherwise, secure the crossbar assembly using the self-tapping screws(DD) . Then, fully tighten the outlet box screws .

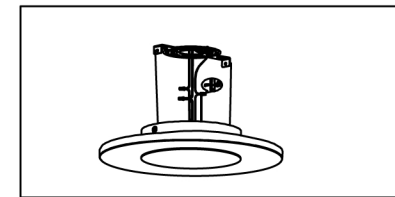

3.)

Step 3: Use wire connectors to connect the wires.
Ground wire: 1. Wrap the supply ground wire around the green ground screw on the crossbar assembly , no less than 2 in. from the end of the wire. Tighten the ground screw .
2. Connect the fixture ground wire to the supply ground wire with a wire connector .
Supply wire: 1. Connect the supply white wire to the white fixture supply wire with a wire connector .
2. Connect the supply black (or red) wire to the black fixture supply wire with a wire connector .
3. Wrap each connection with approved electrical tape and carefully insert all of the connected wires into the outlet box.

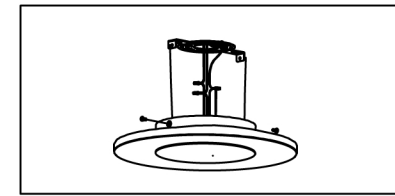

4.)

Step 4: Assembling the fixture body to the outlet box Line up the holes on the ceiling canopy and the mounting holes on the crossbar assembly(FF) . Secure with the lock screws(EE) . Tighten until snug