

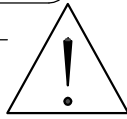

60'

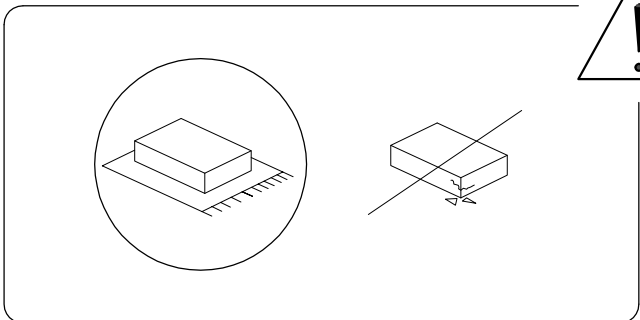
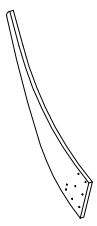

1

A	B	C	D	E
				
x 2	x 2	x 2	x 2	x 35

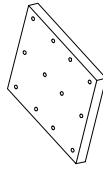
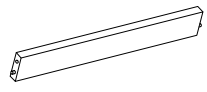
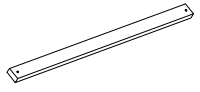
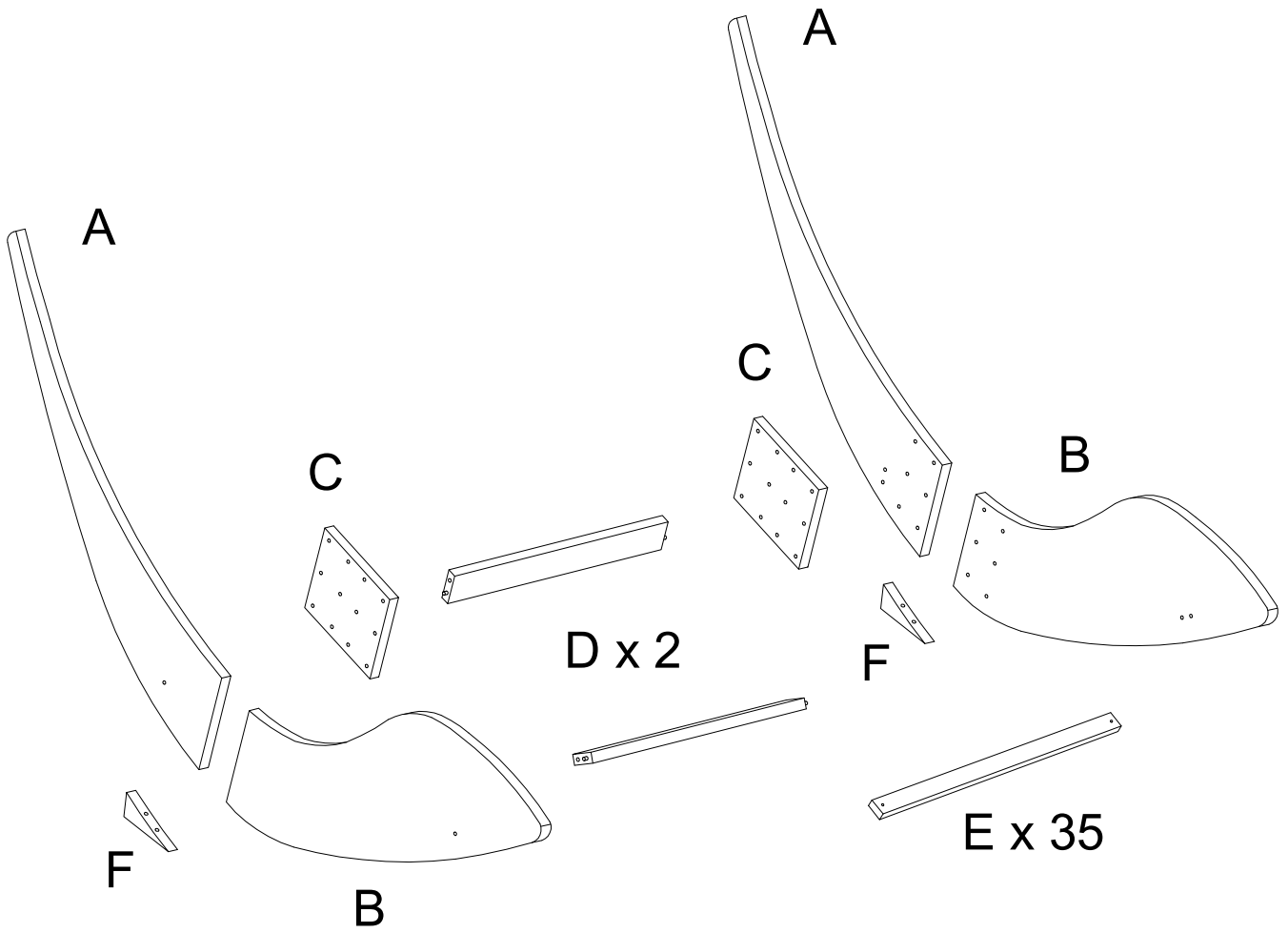

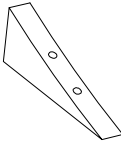
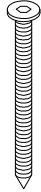
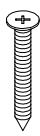
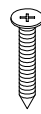
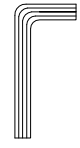
F	G	H	I	J
				
x 2	6 x 60 x 4	4 x 30 x 28	4 x 25 x 70	x 1

1

A



x 2

F

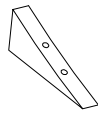

x 2

H

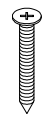

4
x
30

x 4

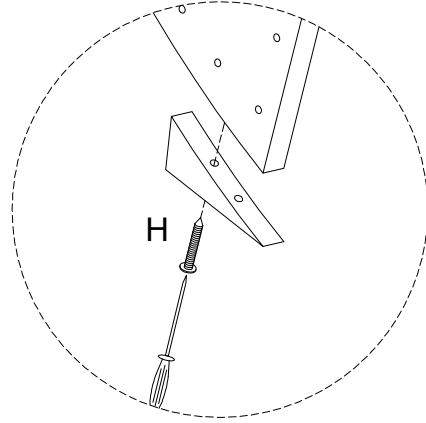
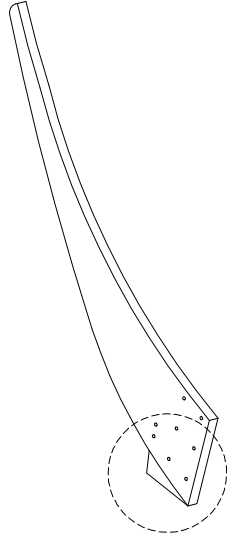

2

B



x 2

C



x 2

H

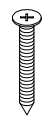

4
x
30

x 24

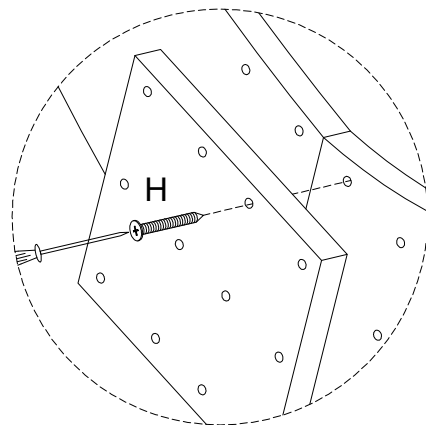
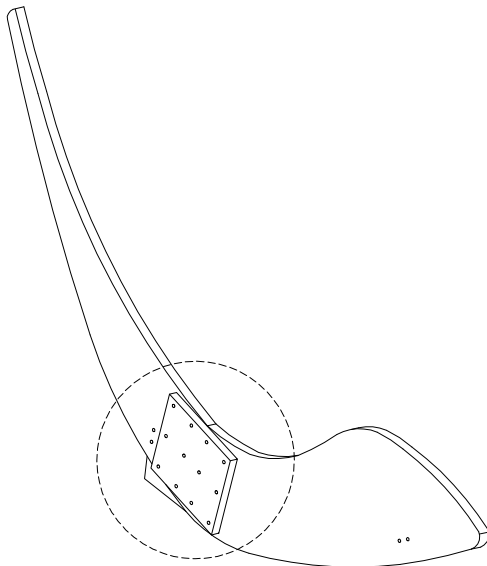

3

D

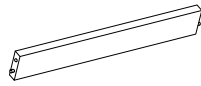

x 2

G

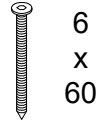

x 4

J

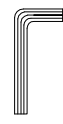

x 1

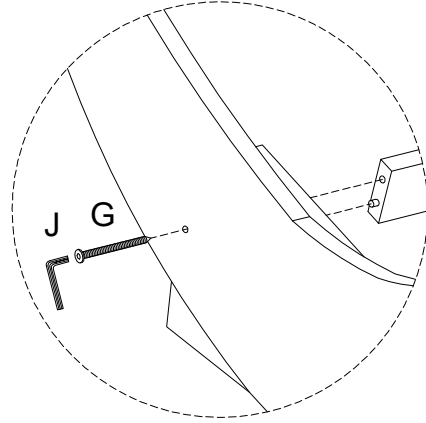
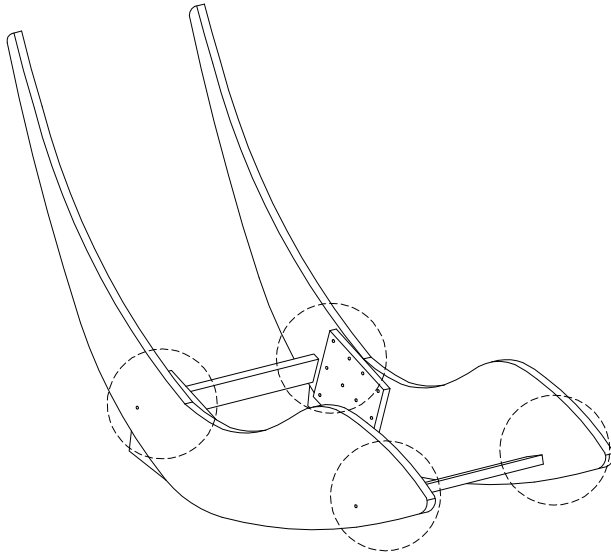

4

E

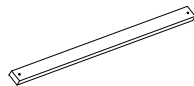

x 35

I

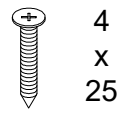

x 70

