

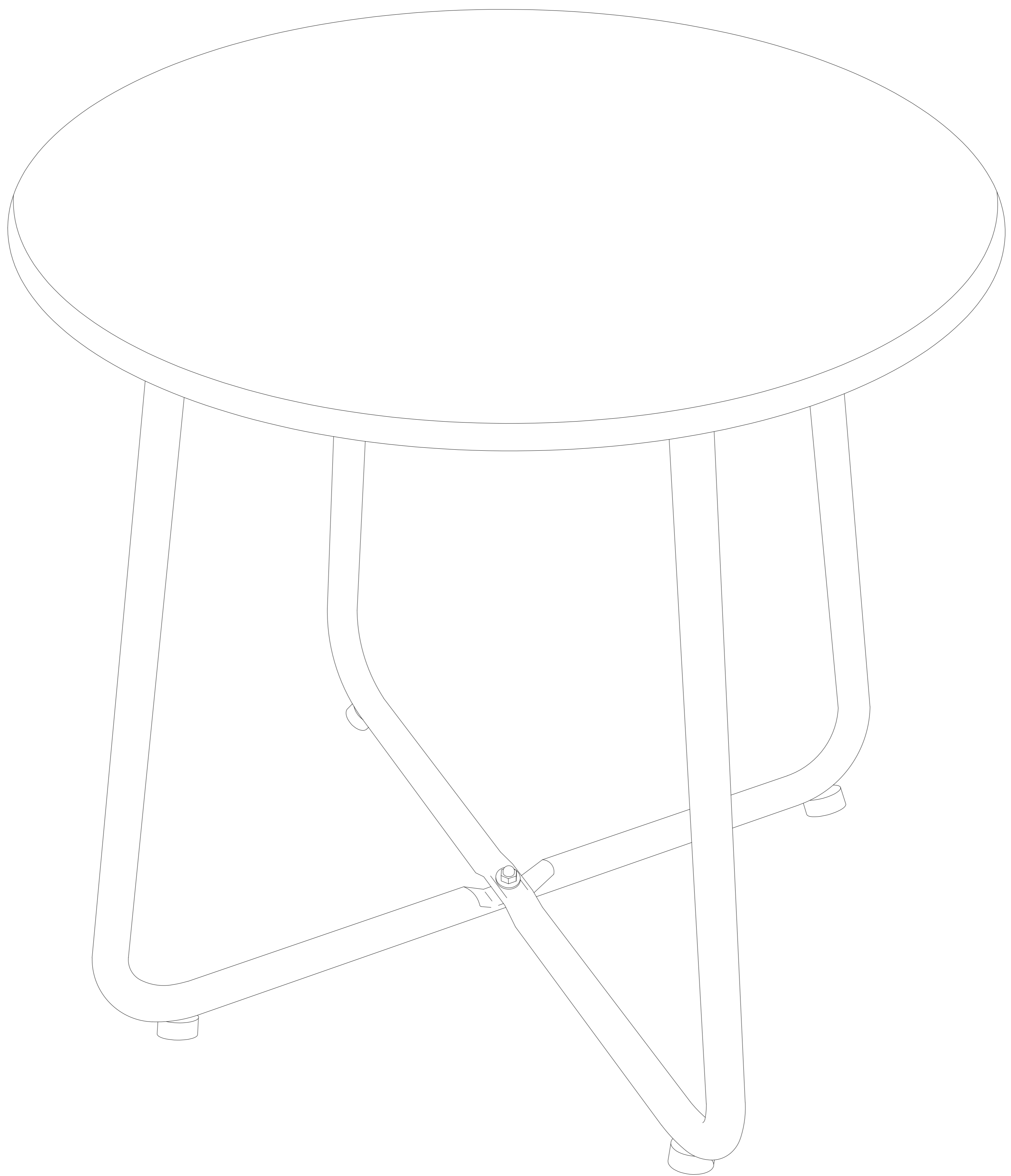

Instructions for Use

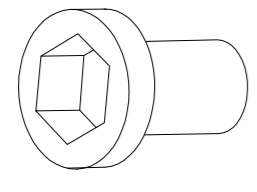
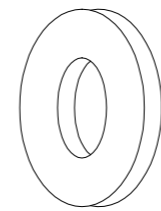
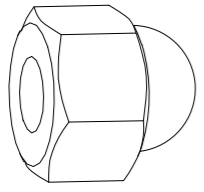
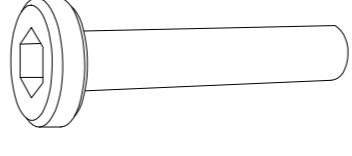
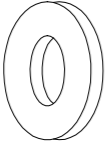

a		M8*10	4	b		M8	4
c		M6	1	d		M6*25	1
e		M6	1	f		M6	1
g		M8	1	h		M6	1

		
A ×1	B ×1	C ×1

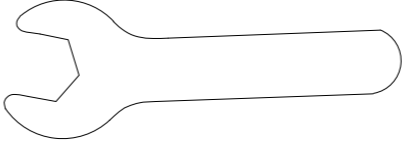
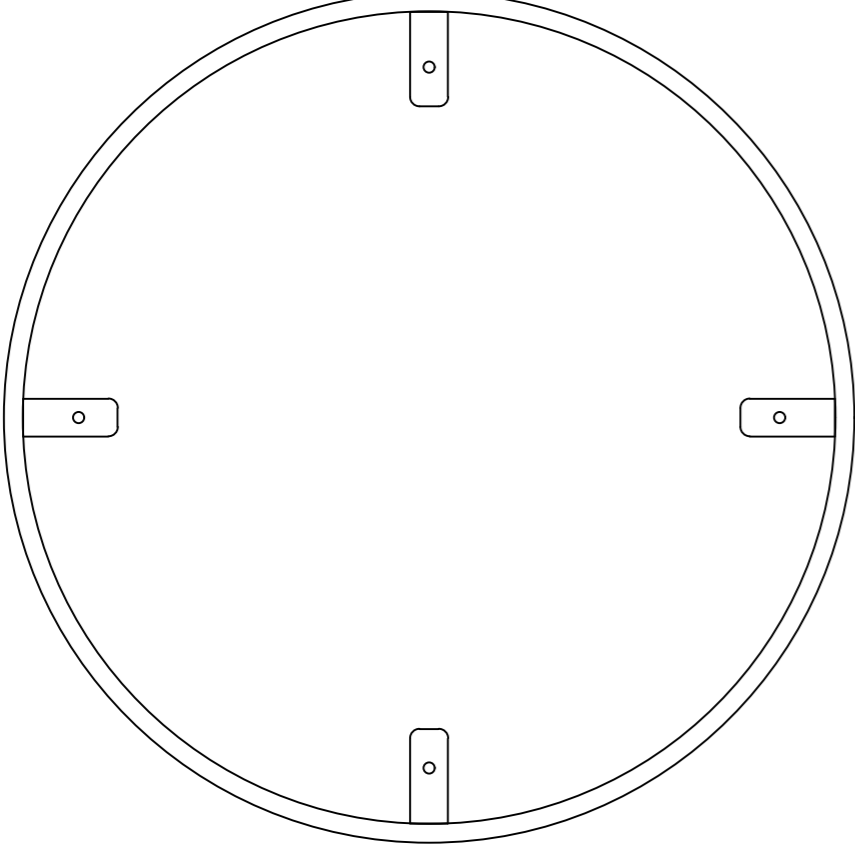
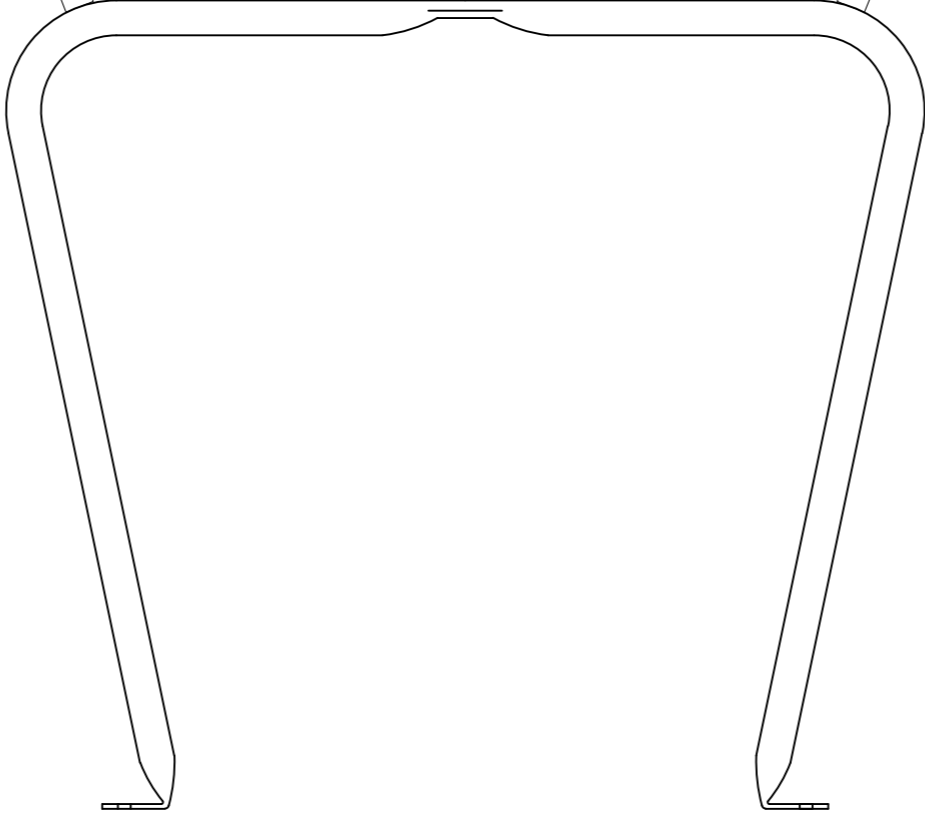
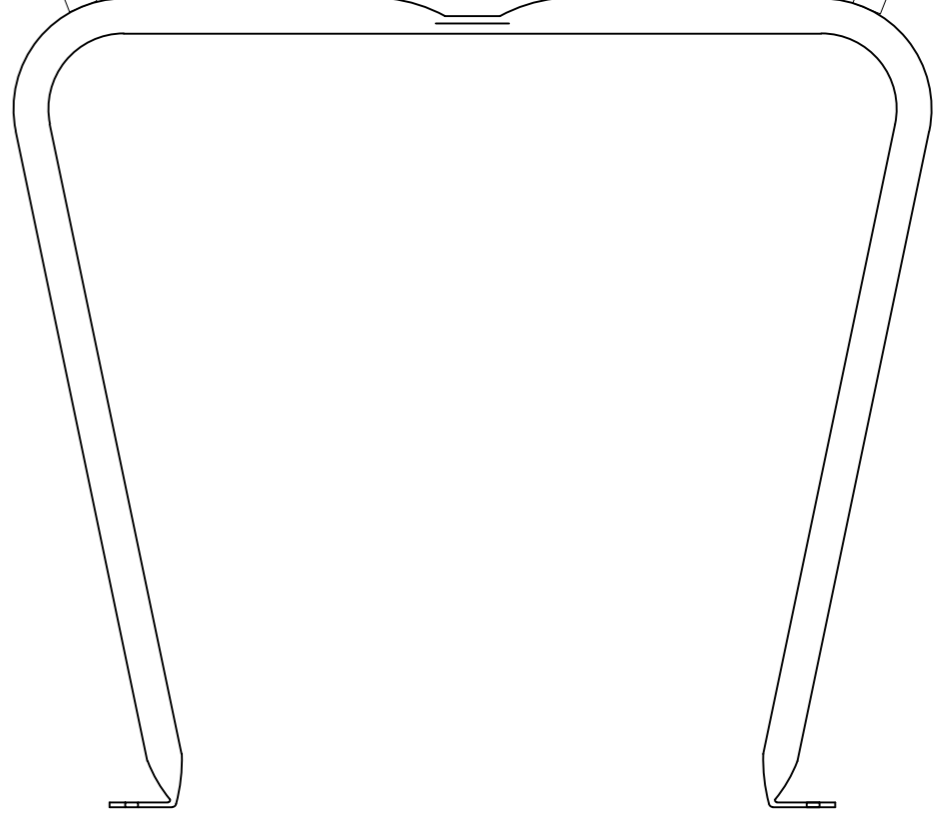
1

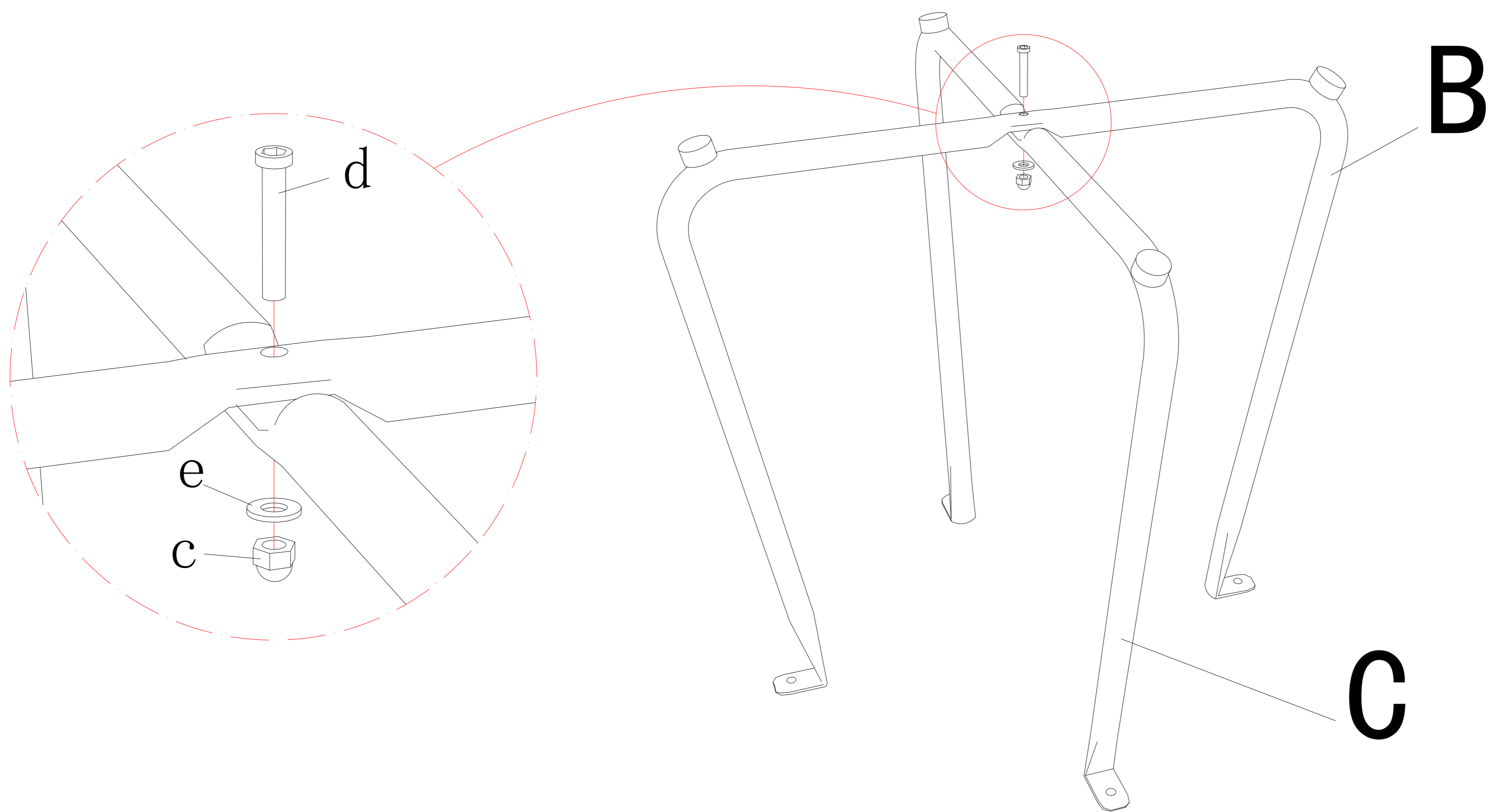
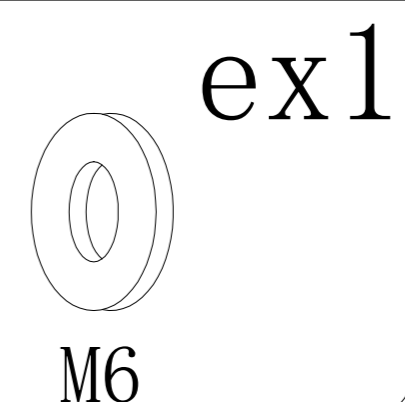
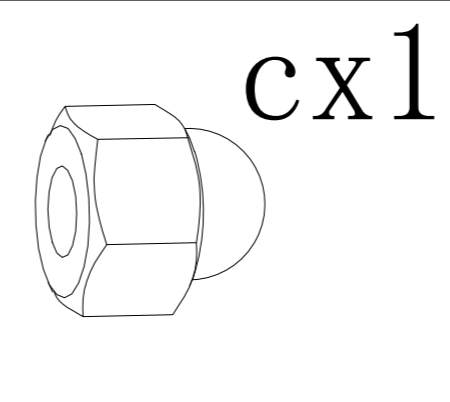
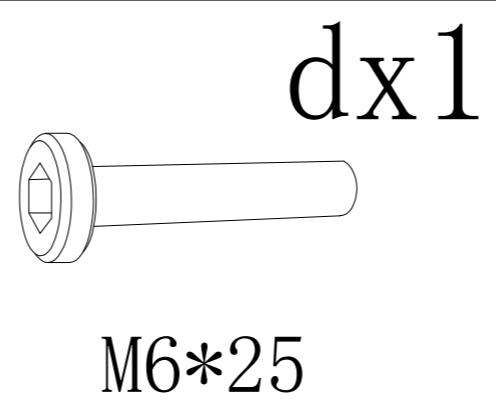
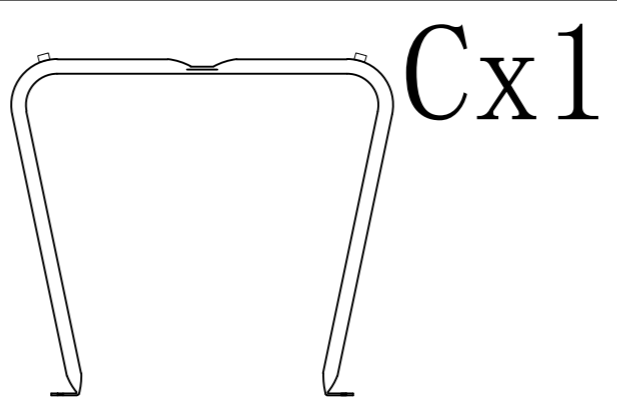
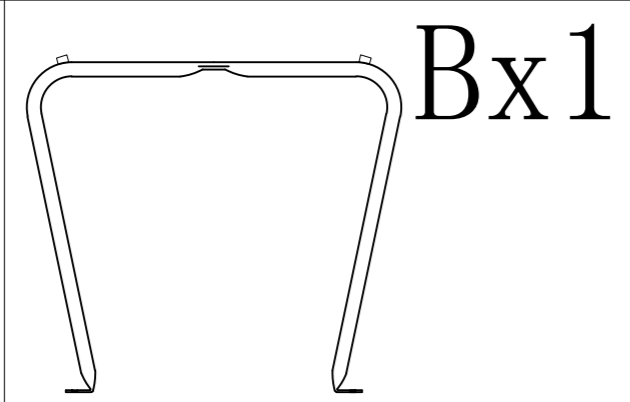

2

