

# Steel Gazebo

---

















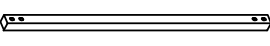





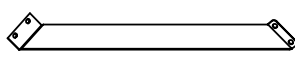
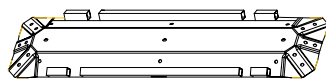
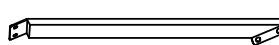



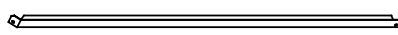

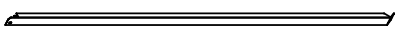
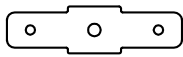
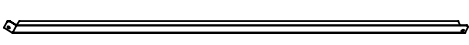

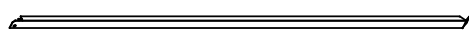

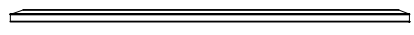
## Assembly Instruction

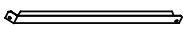

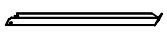





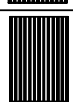

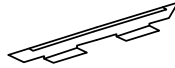

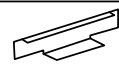











OB-HTG015 (DA003-3)

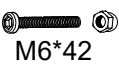

We are forever grateful and appreciative of you considering purchasing our product. After careful evaluation of our product serie, we are excited to launch this product to the public as it is more technically advanced with lots of exciting and useful features. One of the great features added to the arsenal is its mere size, which will require 3-4 people with about 4-5 hours of installing time. Making it a beast at its finest!

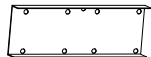
# Steel Gazebo Assembly Instructio

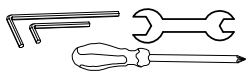
A		4	H		4
B		2	H1		4
B1		2	H2		2
C		2	H3		2
C1		2	J1		4
D		6	J2		4
E		4	K		1
F		4	K1		1
F1		4	L		4
G		6	M1		10
G1		2	M2		8
G2		2	M3		6
G3		2	M4		4
G4		2	M5		96
G5		2	M6		4
G6		2	M7		2
G7		2	M8		4
G8		2	N1		2
G9		2	N2		2
G10		2	N3		2

N4		2	R		72
N5		2	R1		20
N6		2	S	 M6*47	14
N7		2	T	 M6*25	82
N8		2	U	 M6*25	1
01		2	U1	 M6*30	4
02		2	V	 M6*15	148
03		2	X	 M6*10	32
04		2	X1	 M6*42	8
05		2	W	 M6*50	10
06		2	Y	 5*12	64
P		4	Z1		1
Q		48			1
I		4	M9		4



STEP 1: Attach Foot Base ( Part L) to the Pillars (Part A)

STEP 1

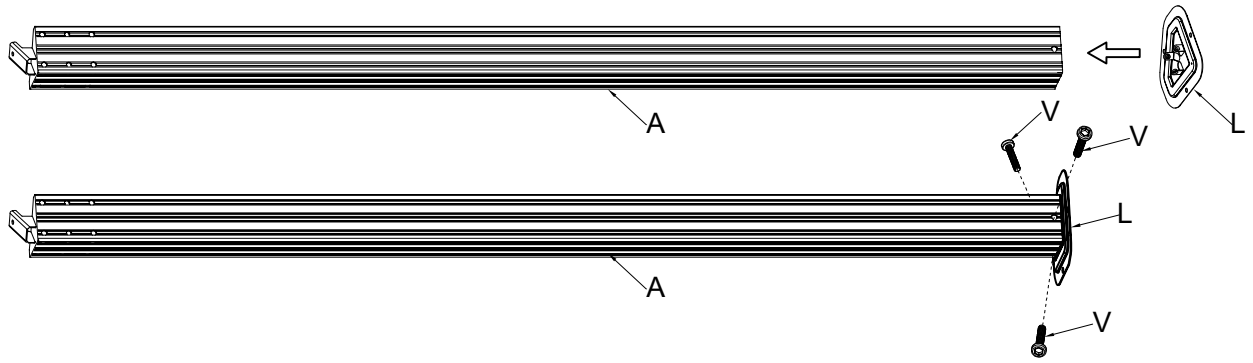

STEP 2

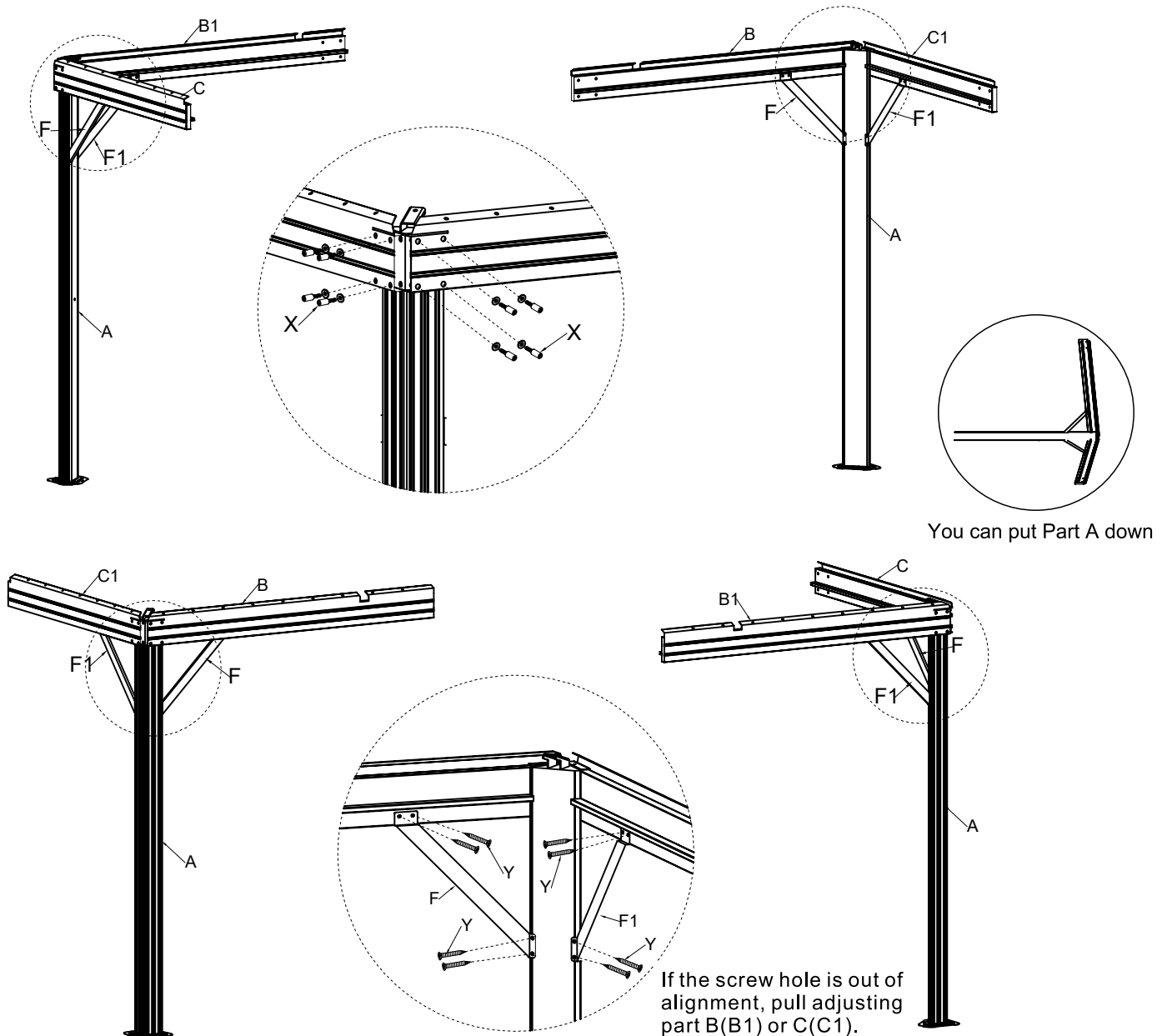

STEP 2: Attach Crossbeams 1 (Part B) and Crossbeams 4 (Part C1) to Pillars (Part A) . Attach Support Brackets ( Part F and F1) to Crossbeam and Pillar. Attach Crossbeams 2 Part B1) and Crossbeams 3 (Part C) to Pillars (Part A). Attach Support Brackets (Parts F and F1) to Cross Beam and Pillar



## STEP 5-1

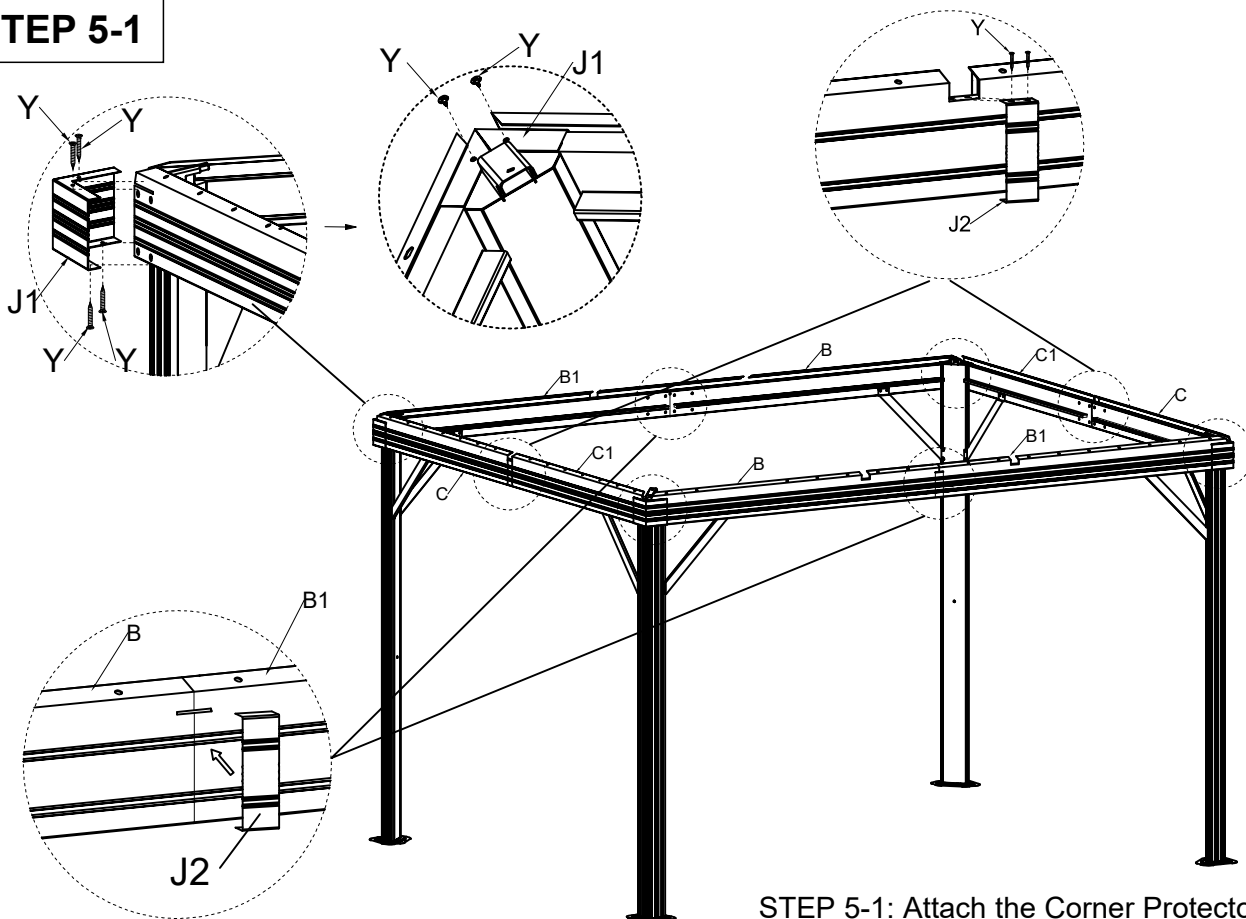

STEP 5-1: Attach the Corner Protectors (Part J1) and the Rib Supports (Part J2) Just twist the top two screws of (Part J2)

## STEP 5-2

STEP 5-2: Slide 7 Netting Hooks (Part Q) into Long Crossbeams (Parts B and B1). With the sections laying on their side, Slide 5 Netting Hooks (Part Q) into Short Crossbeams (Parts C and C1). Then Attach (Part M6)  
Note: There are two tracks. You can choose either track to install Part Q

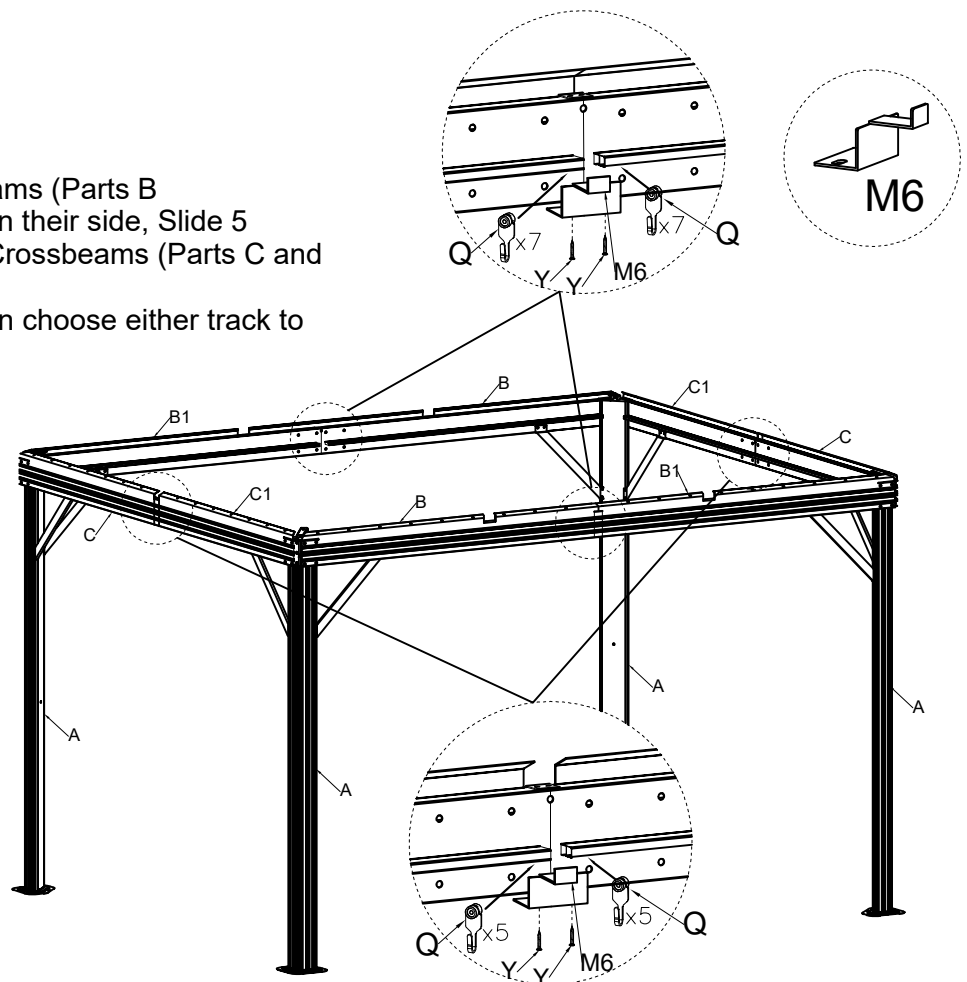

## STEP 6

STEP 6: Assemble the Roof Frame by Attaching the Roof Ribs Long (Part E) to the Roof Top Brace (Part K1).

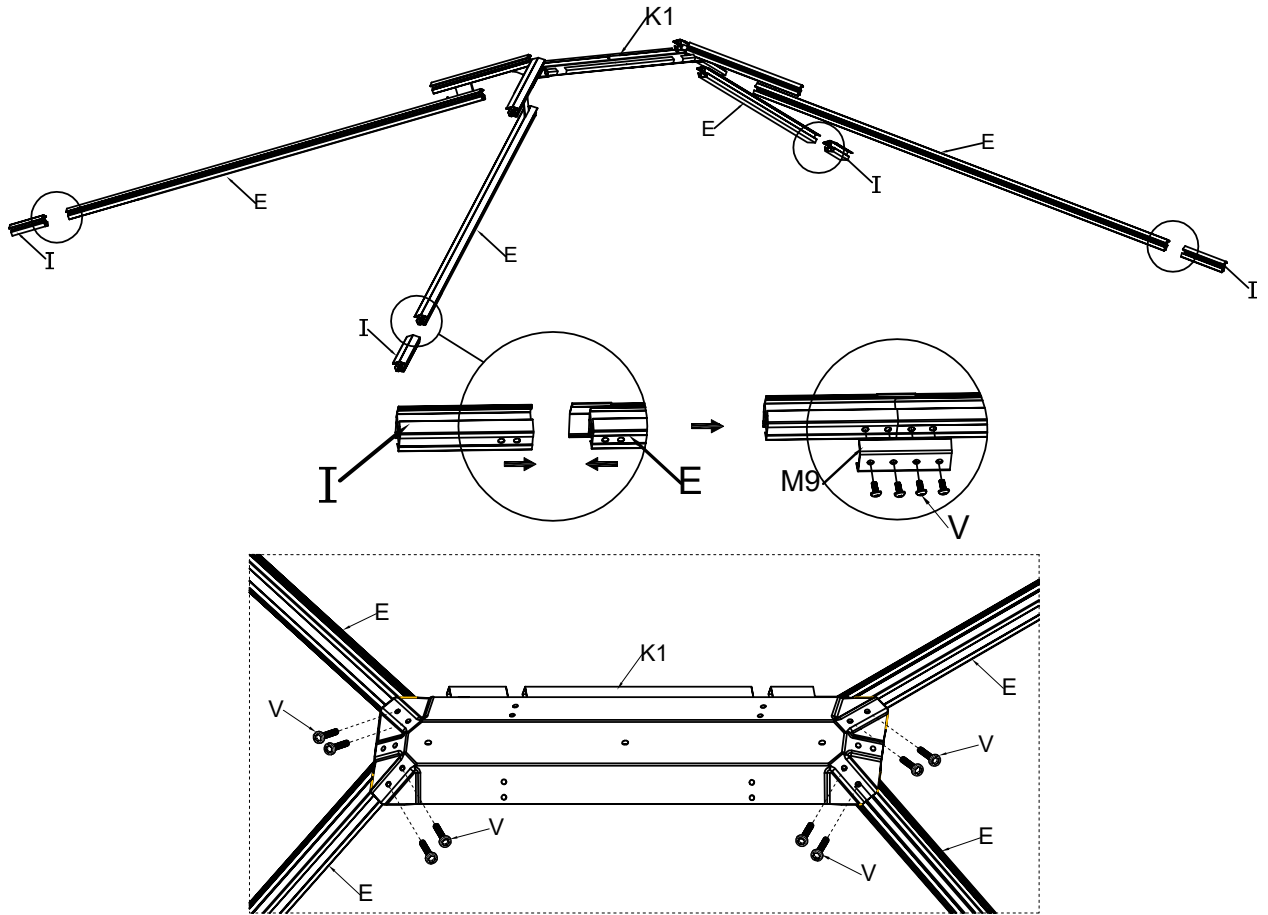

## STEP 7

STEP 7: Lift the Partially assembled Roof on to the assembled Frame and attach.

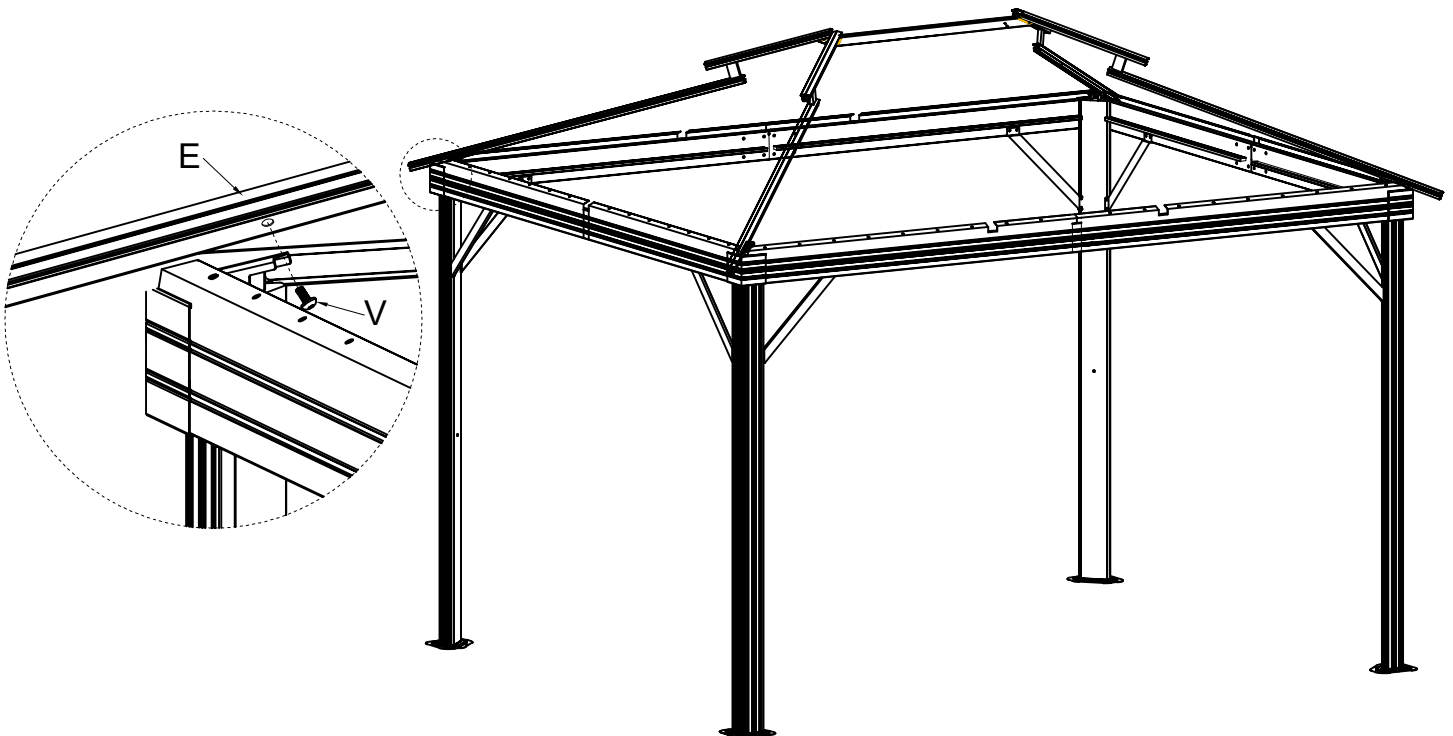

## STEP 8

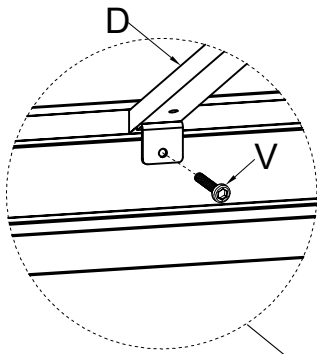

STEP 8: Attach the Roof Ribs Short (Part D) to the Roof Top Brace (Part K1). Attached the Roof Ribs Short (Part D) to the assembled frame.

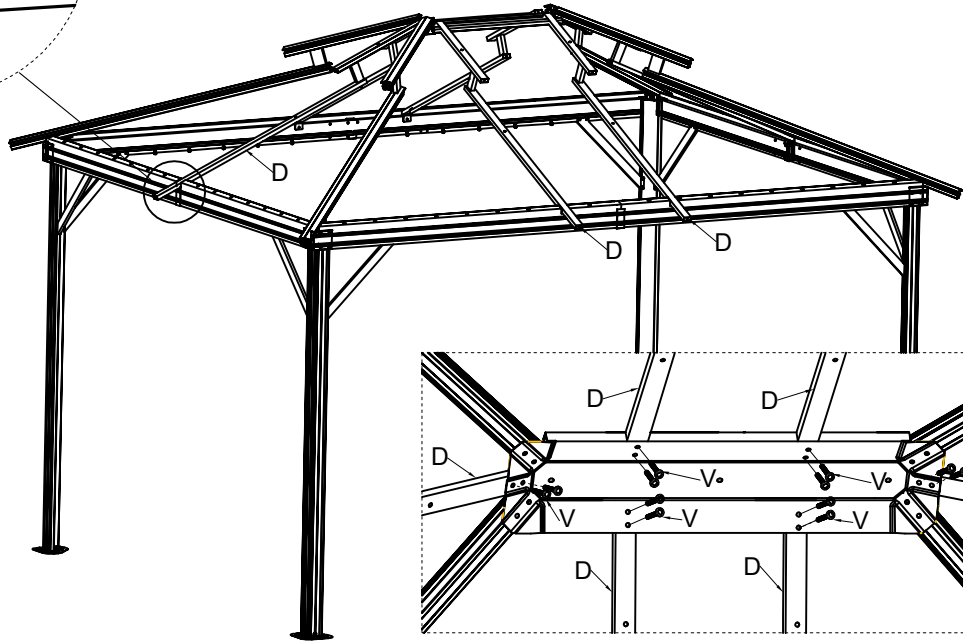

## STEP 9

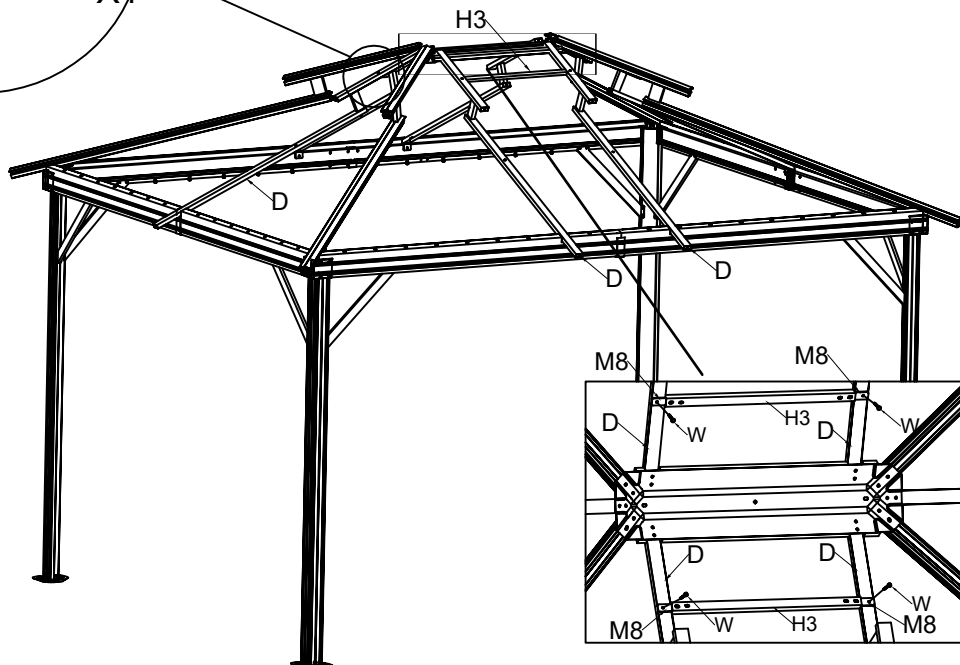
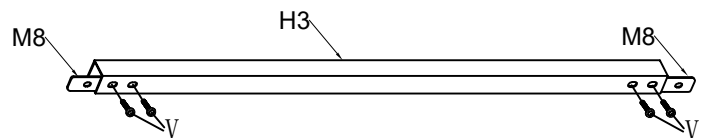
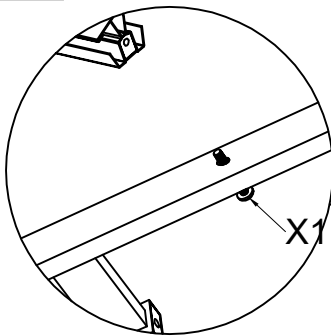

# STEP 10

STEP 10: Attach the Clips (Part R1) and Clips (Part R) as shown in the diagram.

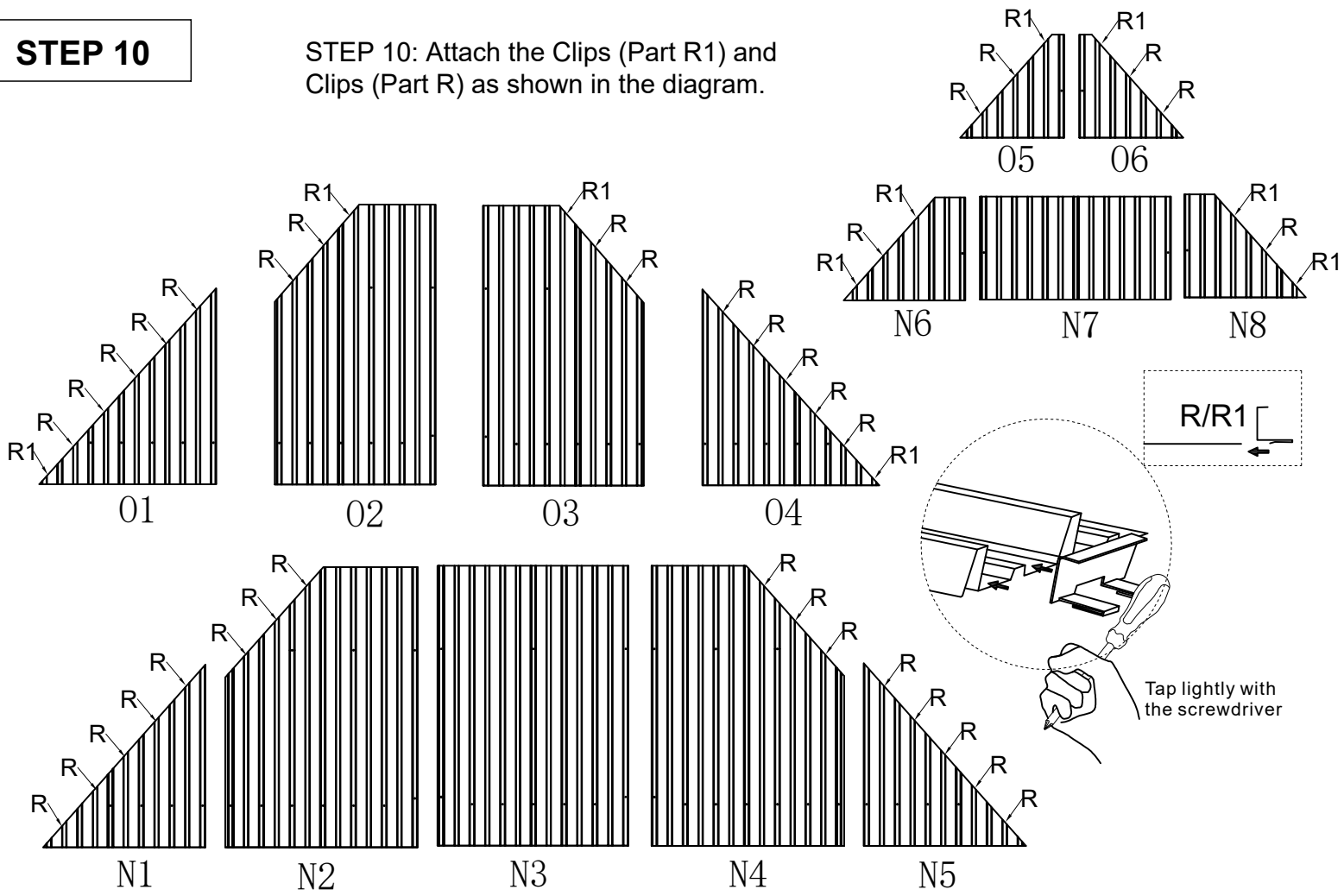

# STEP 11

STEP 11: Install the Roof Plates (Part N6 N7 N8) on the Long Sides of the Gazebo. Install the Roof Plates (Part O5 O6) on the Short Sides of the Gazebo.

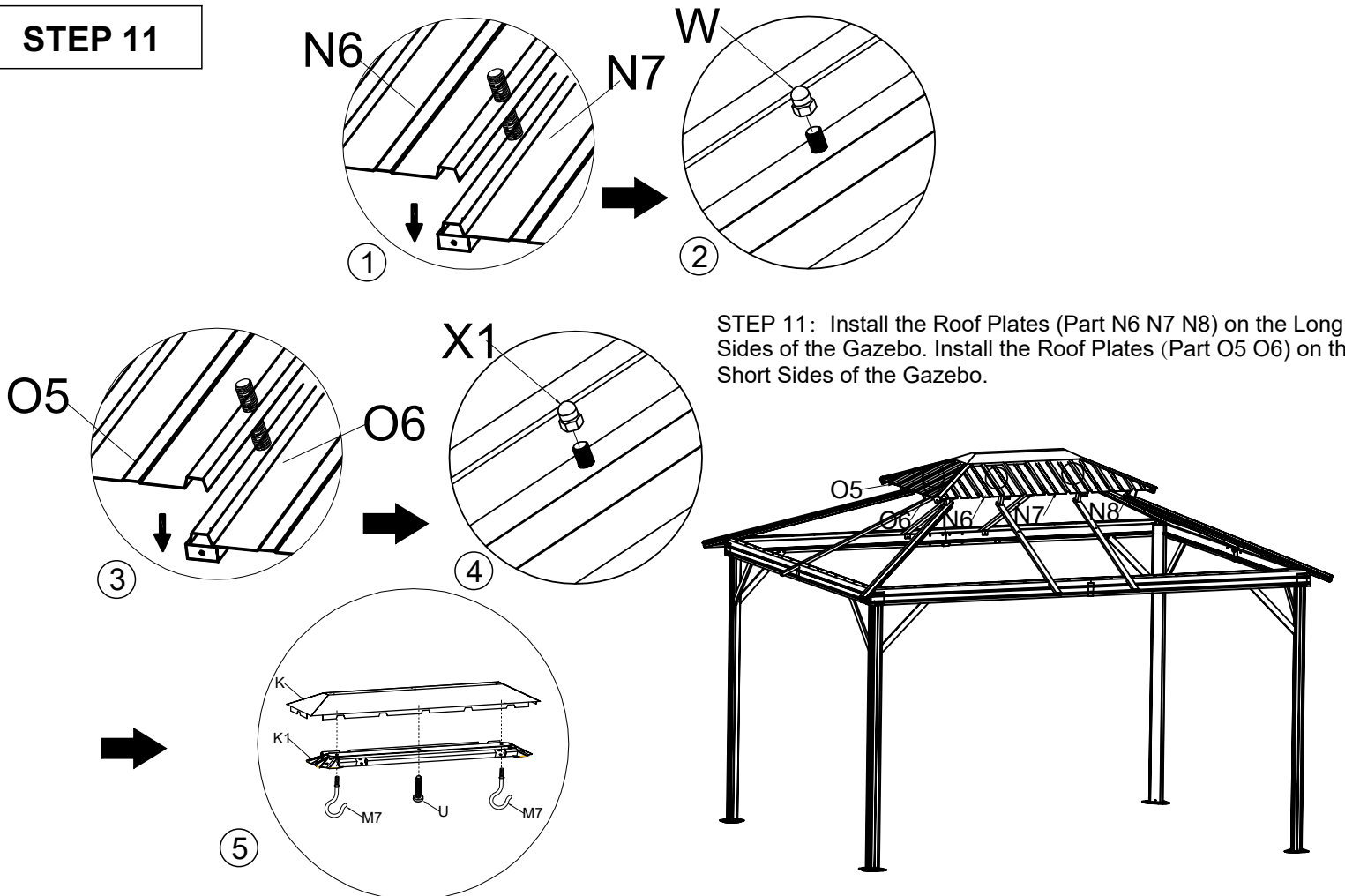

## STEP 12

STEP 12: Tighten the screw (part U) halfwy, then install (Part G G5 G6 G7), and finally tighten the (Part U)

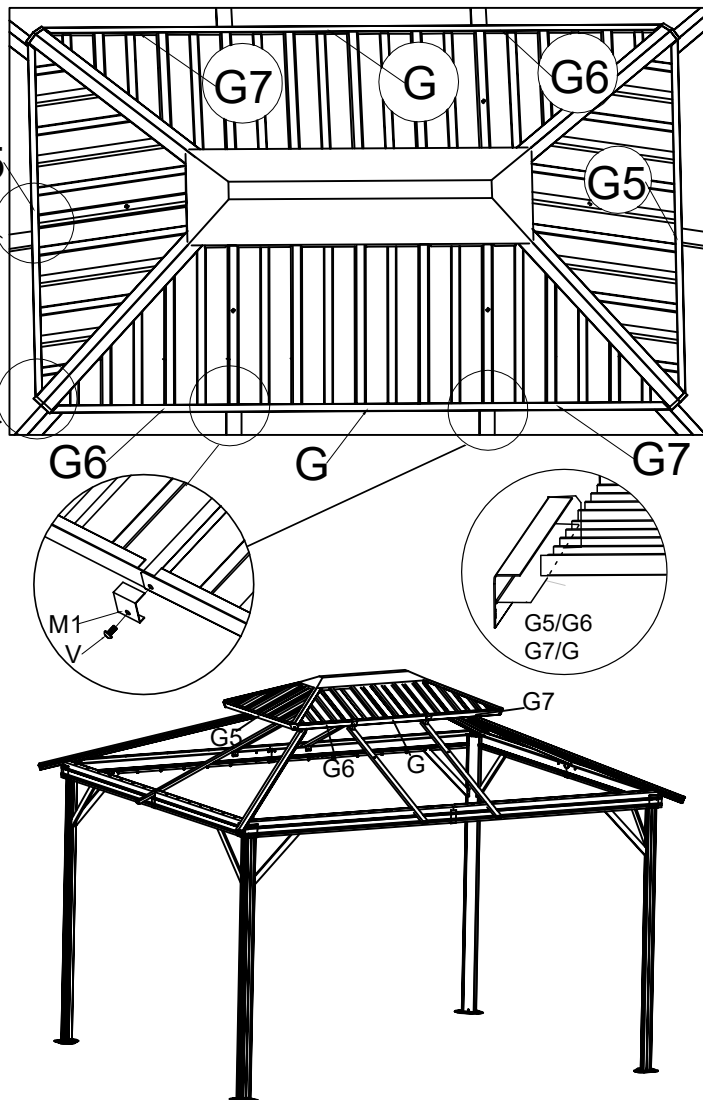
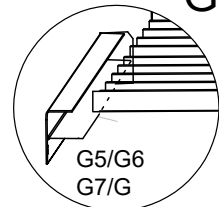
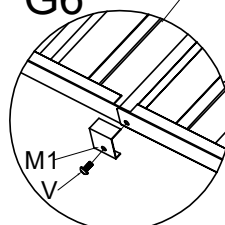
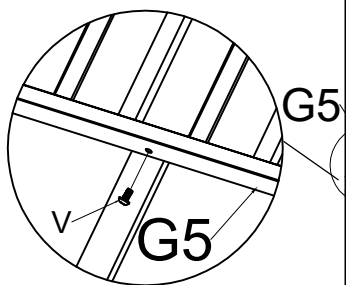
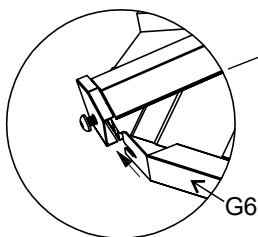
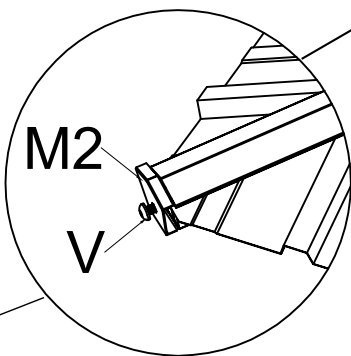
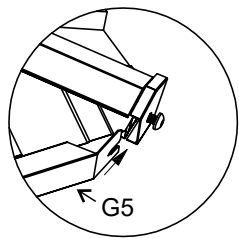

## STEP 13

STEP 13: Attach the Roof Supports (Part H H1 H2) to the roof frame using Connectors 1 (Part M3) and Connectors 2 (Part M4) as shown in the diagram

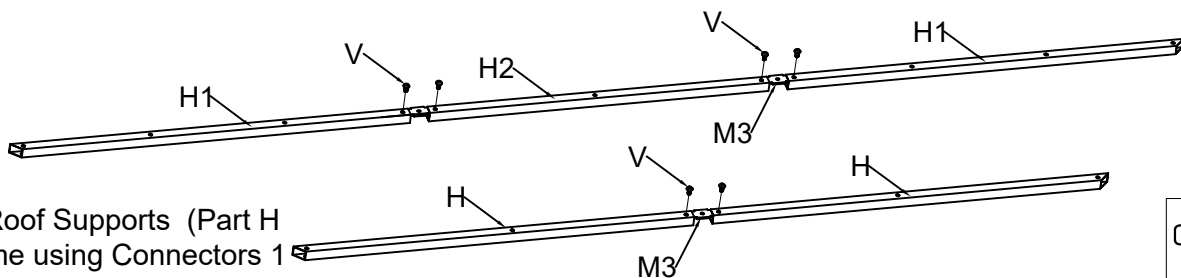

Don't tighten all the screws, just hold the (Part H and Part H1), until all of them are fixed

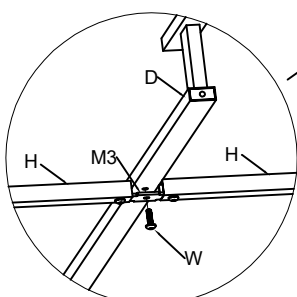
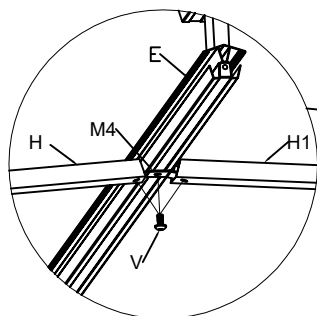
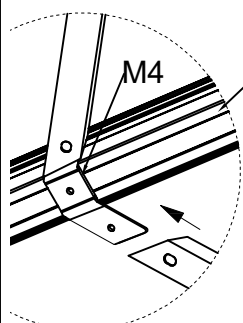
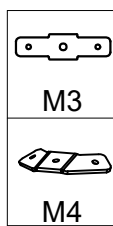

Please note that Parts M3 are installed on Parts D, and Parts M4 are on Parts E.

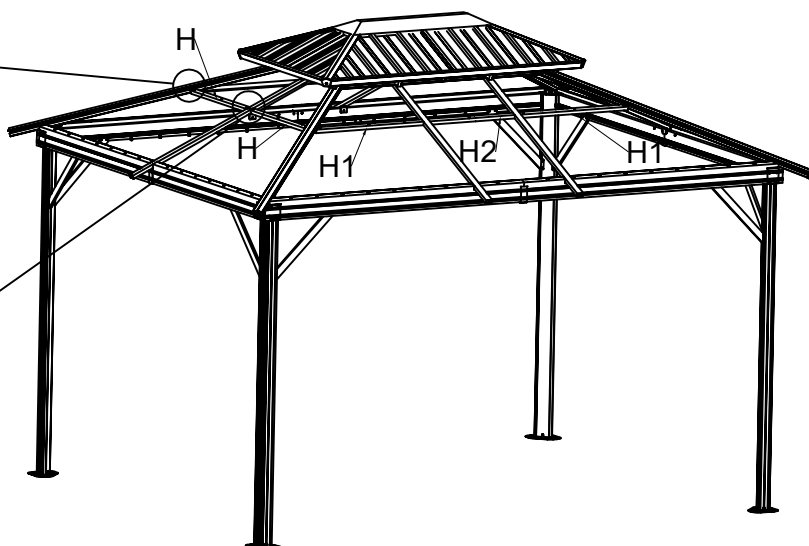

# STEP 14

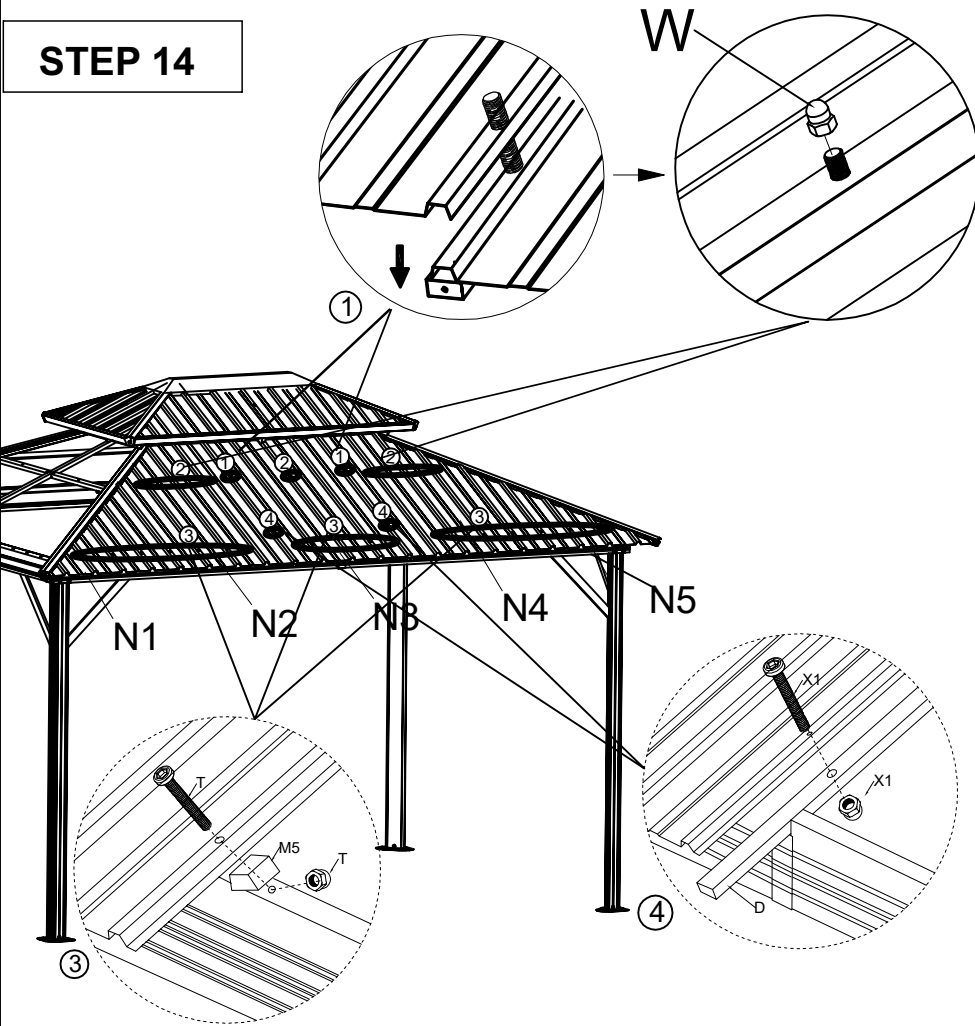

STEP 14: Part N1 N2 N3 N4 N5 for the Long Sides of the Gazebo, Part O1 O2 O3 O4 for the short Sides of the Gazebo.

Install the Roof Plates on the Long Sides of the Gazebo. Start by sliding Roof Plate 1 (Part N2 N3 N4) into position. Then N1 and N4. The same for the other three sides.

# STEP 15

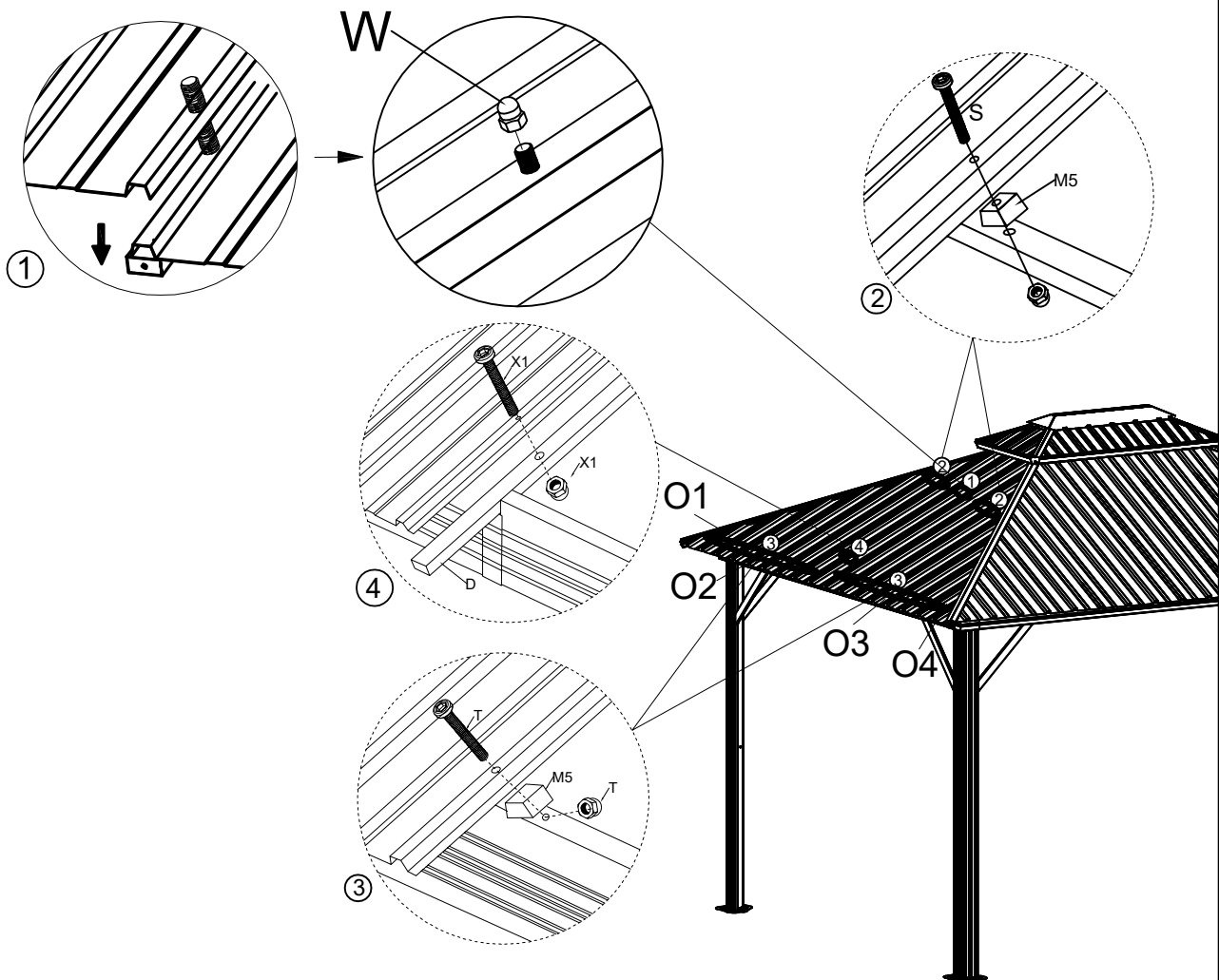

## STEP 16

Note: First fix 4 (Part M2) with V, but do not screw too tight, then install (Part G G1 G2 G3 and G4 ) as shown in the diagram. You'd better from left to right. Attach the Center Rib Braces (Part M1) as shown in the diagram.

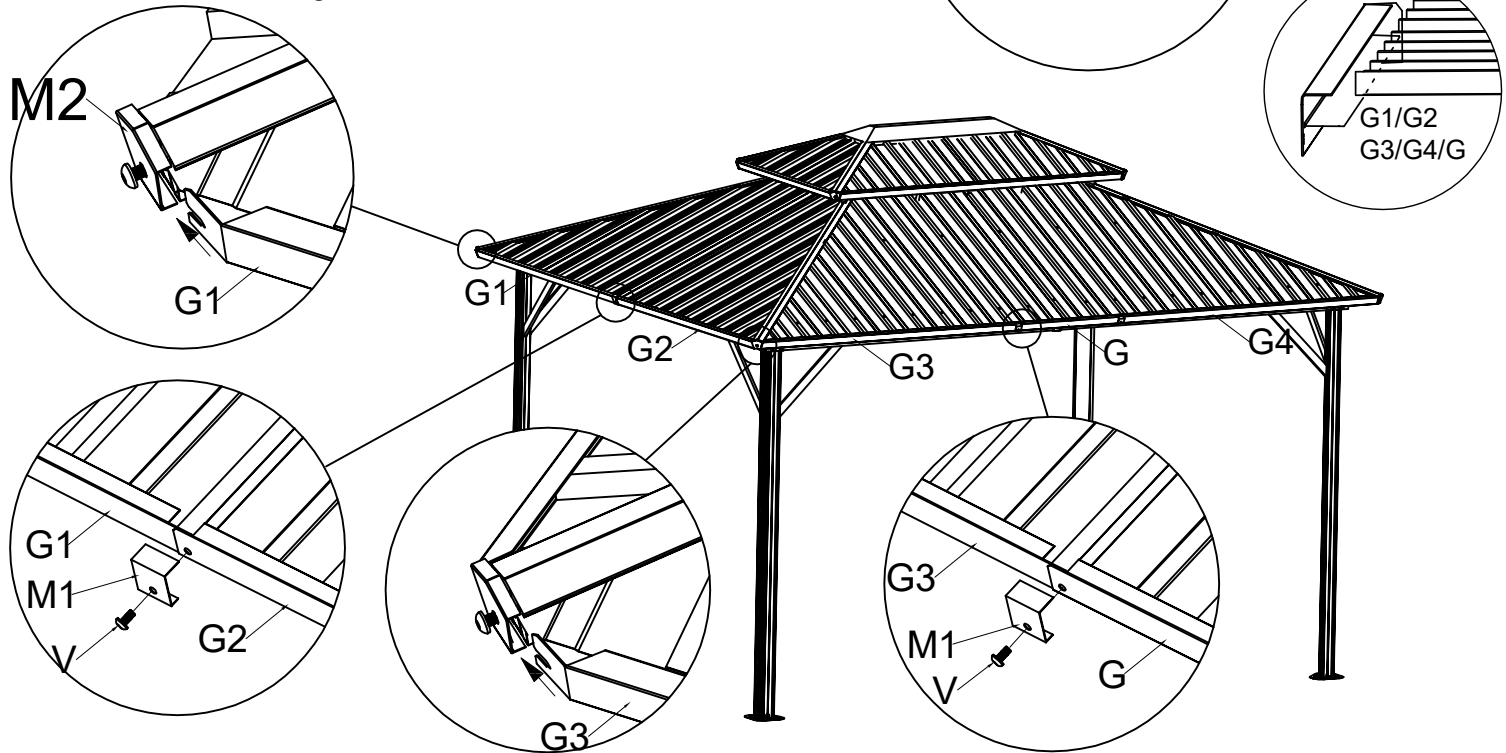

## STEP 17

STEP 17: Fix 4 U1 with V (just screw in a little), then install G G8 G9 and G10 from left to right as shown

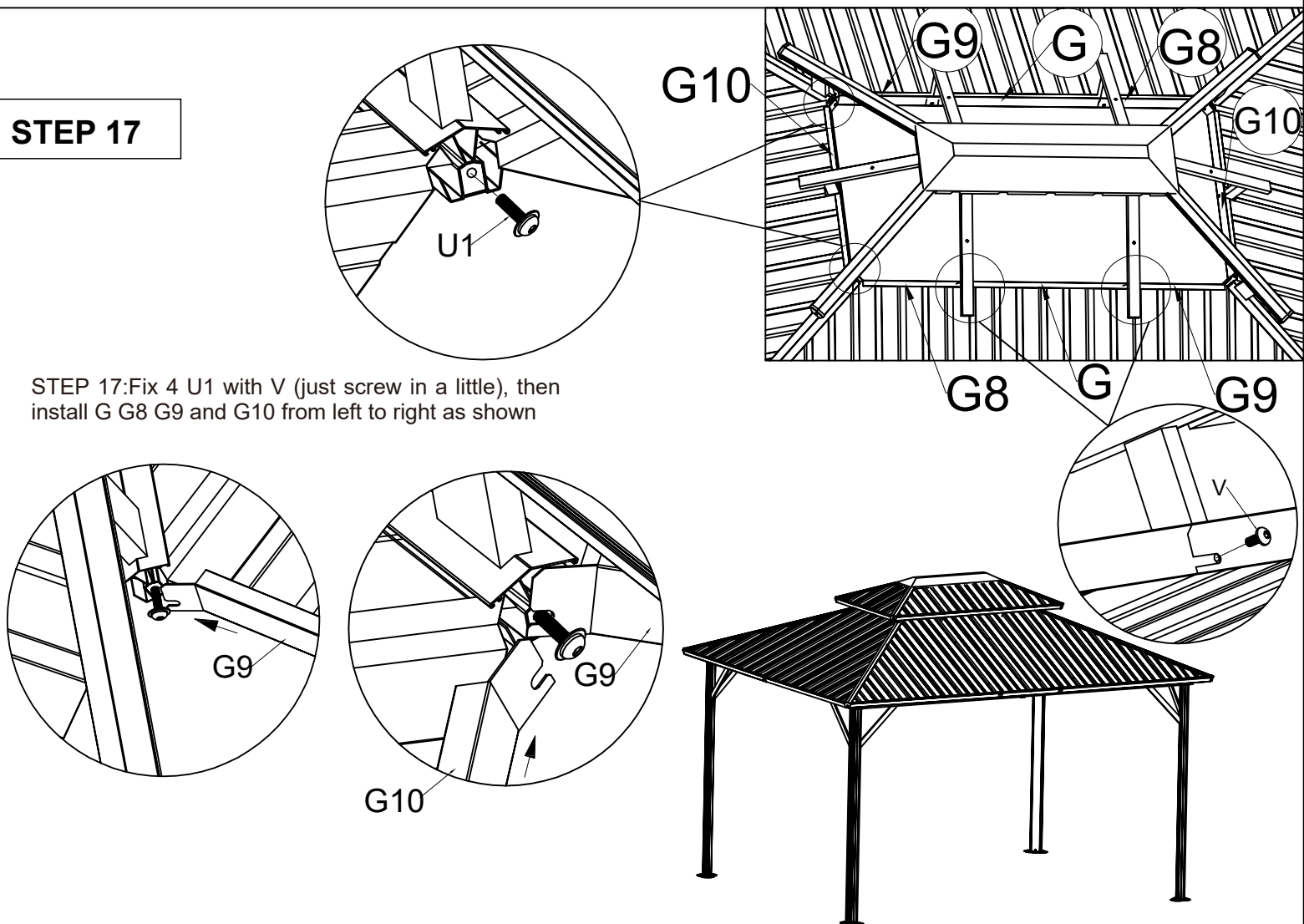

# STEP 18

STEP 18: Install the Mosquito Netting as Shown in the iagram.

