

STEP 3

In order to prevent product tip over, please follow the instruction below to secure the unit to the wall.

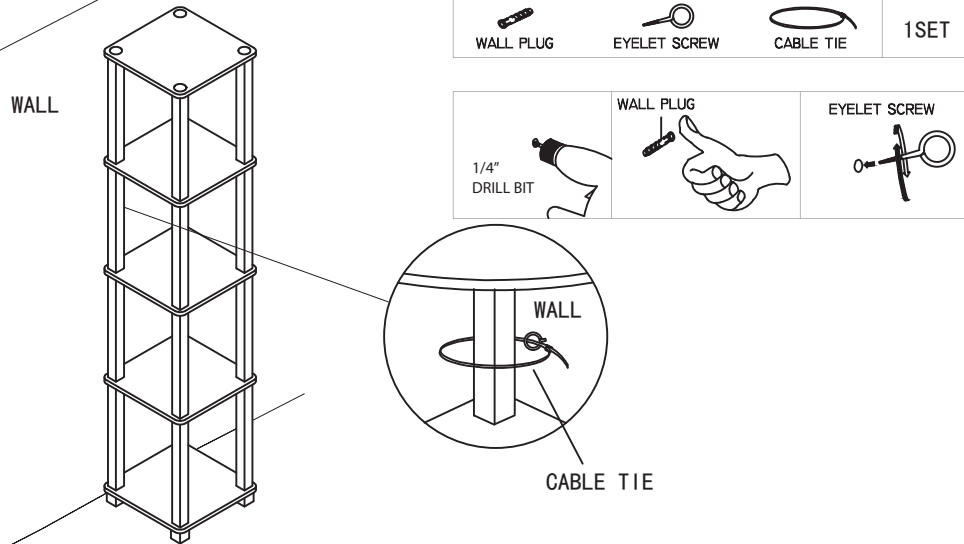

Recommended Maximum Weight

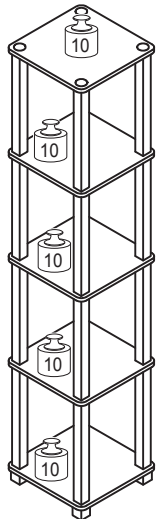

*Unit in Pound(lbs)

WARNING:

>This unit has been designed to support the maximum loads shown. Exceeding these load limits could cause sagging, instability, product collapse, and/or serious injury.



>DO NOT allow children to climb on unit.

>Put heavier items on lower shelves.

Assembly Instruction

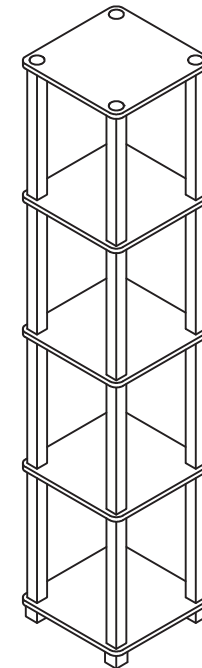
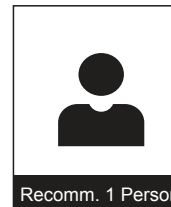
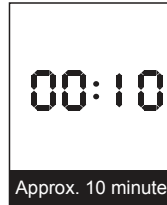
Turn -N-Tube 5-Tier Corner Square Rack Display Shelf

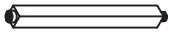

No	Hardware List	Qty
1	Long Pole 	16pcs
2	Square Leg 	4pcs
3	Top Cap 	4pcs

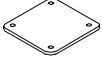
No	Parts List	Qty
A	Shelf Panel 	5pcs

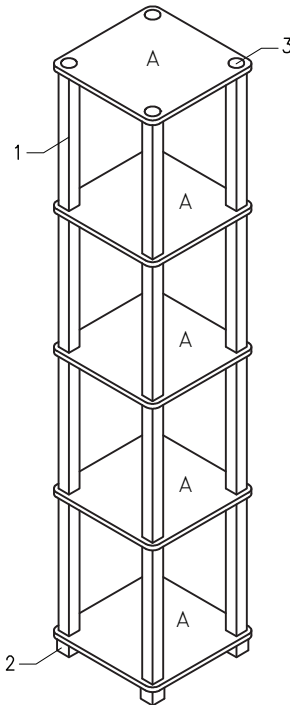

USEFUL HINTS BEFORE YOU START:

1. Read each step carefully before starting.
2. It is important that each step is performed in correct order to avoid difficulties.
3. Identify, sort and count the parts before assembly.
4. Assemble your furniture on packaging cardboard to prevent scratch or damage.
5. Clean the product with mild cleanser using soft damped cloth. Do not use harsh or abrasive cleanser.
6. Using incompatible hardware might cause damage to product.

STEP 1

Attach Square Leg (2) to the bottom of Shelf Panel (A), as shown.

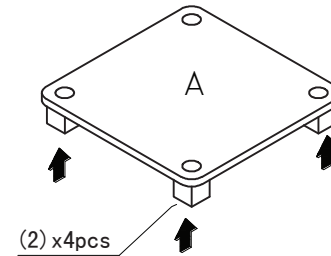

STEP 2

- 2.1 Tighten Long Pole (1) and attach Shelf Panel (A) to the assembled unit, as shown.
- 2.2 Fix Top Cap (3) on the top of Shelf Panel (A), as shown.

