

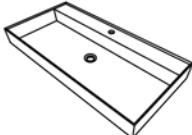









PRODUCT ASSEMBLY INSTRUCTIONS

[Product Model: FS106-1000]

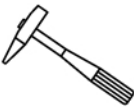
List :

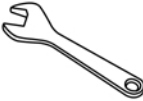
				
Solid Surface Bathroom Sink	Bolt x4	Nut x4	Metal Washer x4	Expansion sleeve x4

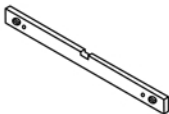
Tools Required :

						A	Hammer
A	B	C	D	E	F	B	Pencil
						C	Wrench
						D	Electrodrill
						E	Gradienter
						F	Steel tape

Installation Steps : 1

Determine the mounting holes based on the holes in the back of the basin and mark the wall with a pencil (33"-36" is preferred for countertop height).

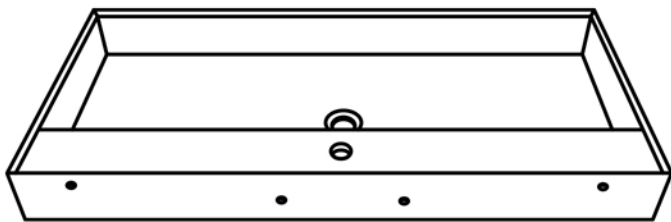

[The back of the product]

Installation Steps : 2

Drill the hole at the mark with electric drill.

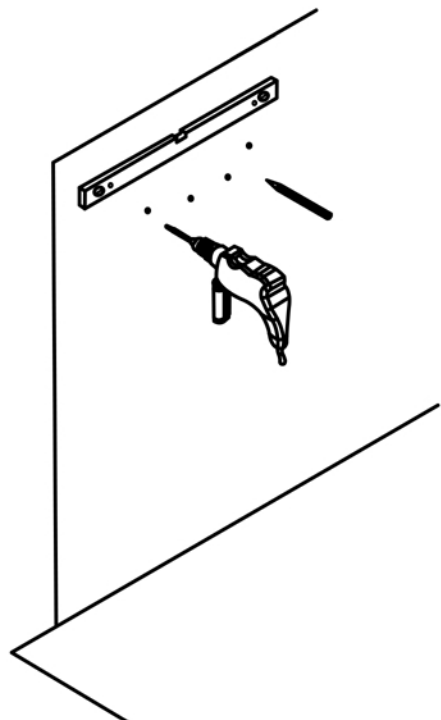

Installation Steps : 3

Knock the white rubber plug of wall-hung accessories into pre-drilling hole with hammer.

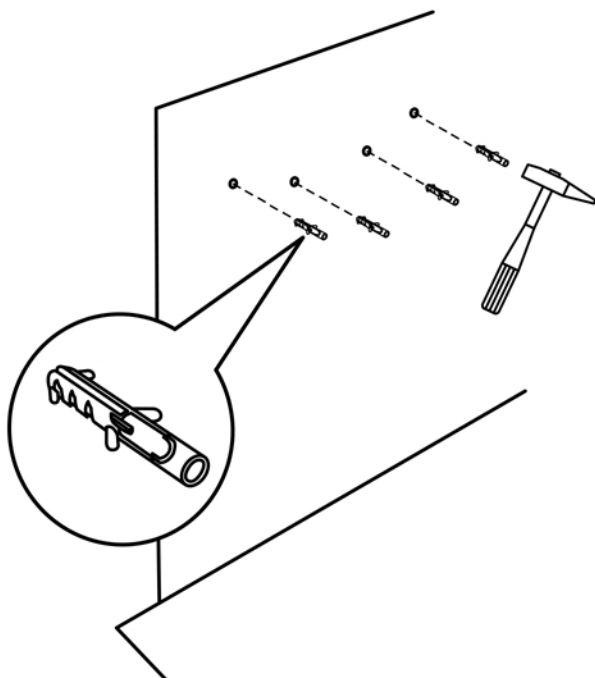

Installation Steps : 4

Hold the basin and use a spanner to lock the basin to the wall.
 ⚠ Pre-installation of bolts in the bolt holes of the basin.

