

## **A note about our online installation instructions:**

Most Modern Fan Co. products have been in our assortment for several years or longer. As we continually work to improve product performance and user experience, we occasionally introduce subtle (and sometimes dynamic) product changes. These can affect the steps associated with assembly and installation of our products depending on when a fan was produced.

The instructions posted here are intended to represent our most current product versions and configurations and the associated installation steps. If your fan or parts of your fan do not appear to match what is included here, please contact customer service for guidance and support in identifying which version of a fan you may have and provision of the associated installation instructions which correspond to that version.

If in doubt, or if you have any questions at all related to assembly, installation or operation of your fan, please contact us!



709 Washington Street, Ashland, OR 97520  
tel 888-588-3267, fax 541-482-8418  
info@modernfan.com  
modernfan.com

# Torsion

## Installation Instructions and Owners Manual



Models: TOR-XX-XX-XX-XX(X)-XXX  
Net Weight of Fan: 15 lbs (6.8 kgs)



Please read and save these instructions.

If you have any questions while installing your fan, **call us first!**

### Customer Service

Monday–Friday, 8am–4pm (PST)  
tel 888-588-3267

<b>Safety Instructions and Warnings</b> .....	2
<b>Fan Installation</b> .....	4
<b>Control Installation and Wiring</b> .....	8
<b>Troubleshooting</b> .....	12
<b>Maintenance</b> .....	14
<b>Warranty</b> .....	15



# Safety Instructions and Warnings

Please read all safety instructions prior to installing your ceiling fan and save this document for future reference. If you are in doubt with any of the information provided, we recommend that you consult or hire a qualified electrician to install your outlet box and ceiling fan.

If you have any questions or difficulty installing your fan, call Modern Fan Co customer service at **(888) 588-3267**.



**Warning – To reduce the risk of fire, electrical shock, or personal injury please observe the following:**

- ▶ Mount fan to outlet box marked “Acceptable for Fan Support” and use mounting screws provided with the outlet box. **Note:** Most outlet boxes commonly used for light fixtures are not acceptable for fan support and may need to be replaced. Consult a qualified electrician if in doubt.
- ▶ Prior to installation or servicing always disconnect the power by turning off the circuit breakers to the outlet box and associated wall switch location. If you cannot lock the circuit breaker in the off position, securely fasten a prominent warning device, such as a tag, to the service panel.
- ▶ Do not bend the blade brackets when installing the blades, balancing the blades, or cleaning the fan. Do not insert foreign objects in between rotating fan blades.
- ▶ Disconnect the electrical supply circuit to the fan before installing light kit.
- ▶ Do not use this fan with any solid-state speed control device other than one provided or approved by the manufacturer.
- ▶ This fan must be installed with an isolating wall control/switch.
- ▶ All wiring must be in accordance with national and local electrical codes ANSI/NFPA 70. If you are unfamiliar with wiring, use a qualified electrician.
- ▶ Use this unit only in the manner intended by the manufacturer. If you have any questions contact the Modern Fan Co at (888) 588-3267.
- ▶ Use only Modern Fan Co replacement parts.

**Note:** This fan is rated and marked as “Suitable for use in Damp Locations.” This fan is suitable for installation in interior locations protected from weather and subject to moderate degrees of moisture, such as some basements, barns, cold storage warehouses, and similar locations, and also partially protected locations such as under canopies, marquees, roofed open porches, and similar locations. This is not rated, nor intended for use in applications classified as Wet Locations.

## Installation Preparation

### **⚠ WARNING**

Make sure the installation site you choose allows the fan blades to rotate without any obstruction. Allow a minimum clearance of 7 feet (2.1 meters) from the floor to the blades and 30 inches (76 cm) from the wall to the end of the blades.

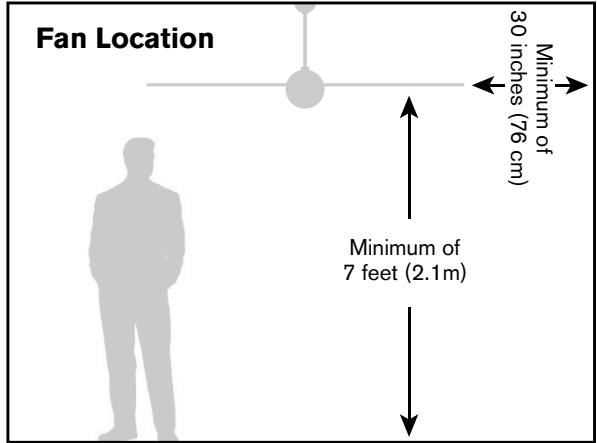

### **⚠ WARNING**

Your new ceiling fan will require a grounded electrical supply line of 120 volts AC, 60 Hz, 15 amp circuit. The outlet box must be securely anchored and capable of withstanding a load of 35 lbs (15.9 ww kg).

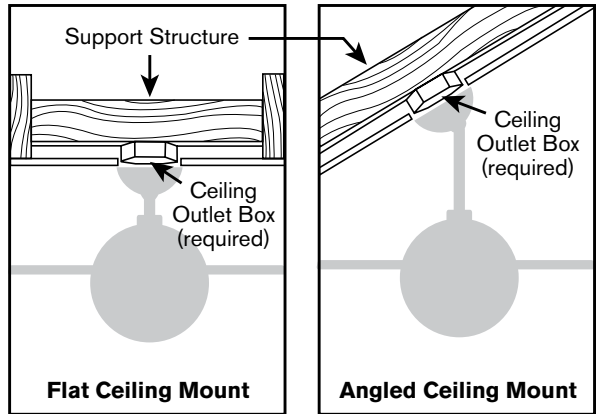

## Control Installation and Wiring

**⚠ WARNING** If you are using an outlet box for wall control installation, the wires coming from the wall control must be grounded using the attached green wire.

After making wire connections, the wires should be spread apart with the grounded conductor and the equipment-grounding conductor on one side of the outlet box and the ungrounded conductor on the other side of the outlet box.

The splices after being made should be turned upward and pushed carefully up into the outlet box.

**⚠ WARNING** This device complies with Part 15 of the FCC Rules. Operation is subject to the following conditions: (1) the device may not cause harmful interference, and (2) this device must accept any interference received, including interference that may cause undesired operation.

# Fan Installation

## Tools Needed

A stepladder, phillips head screwdriver and a wire stripper

## Instructions

- 1 Remove and identify contents of carton.

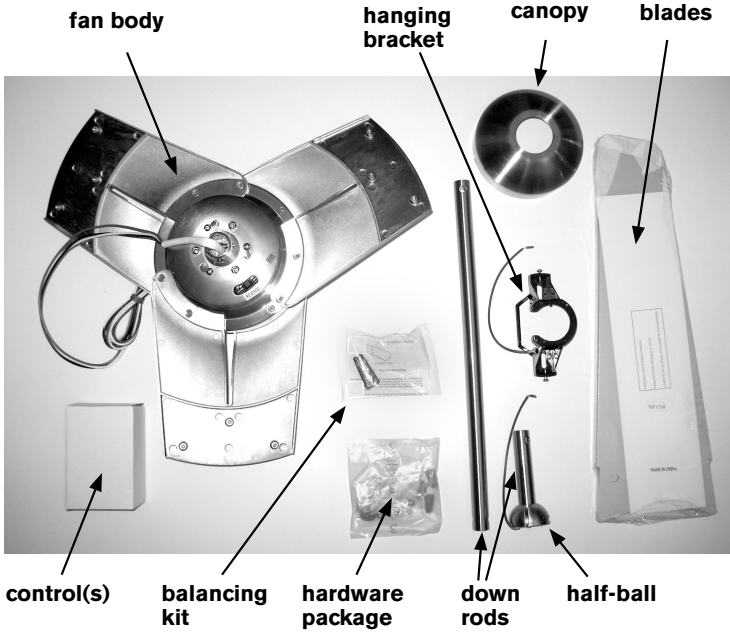

## Optional Light Kit parts:

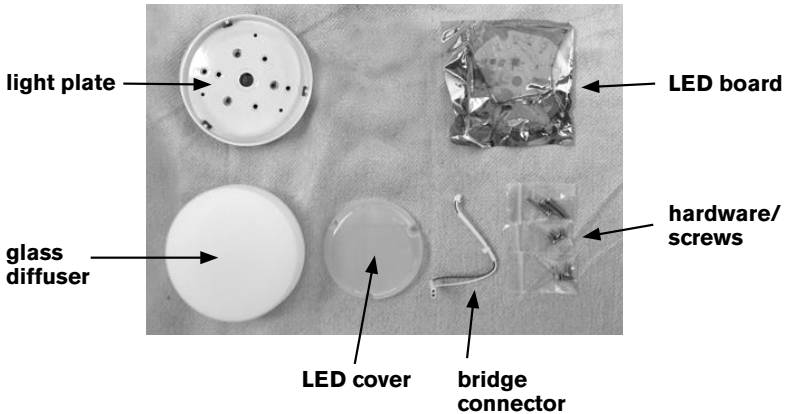



See Page 2

**WARNING**



Circuit Breaker

**POWER OFF**

2

If installing optional LED Light Kit, carefully place the fan on the packing foam (bottom side up) and follow the steps below. Otherwise, proceed to next step.

Remove bottom cap (rotate counter-clockwise to unthread) and remove white plate held by three screws shown here.

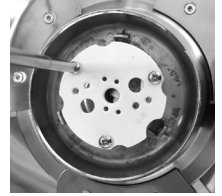

Join ends of bridge connector wires with wire leads from fan. Position wires so that connectors are flat and to the side of three posts inside connection cavity. Depending on date of manufacture, your fan may already have the 2-pin connector pre-wired, in which case the bridge connector is not required.

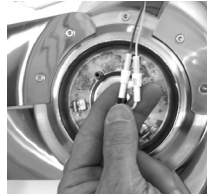

Place light plate over wire connectors so that the three posts are seated in holes on back of light plate and 2-pin connector passes through center hole. Use three countersink screws to fasten light cup in place. There are two sets of attachment holes on the lighting plate. For the Torsion, the flush holes (versus recessed holes) should be used. This will ensure a tight fit between the lighting plate and the bottom of the fan.

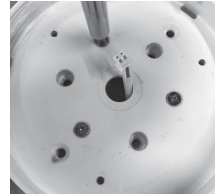
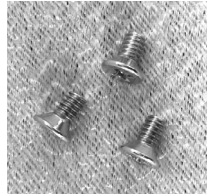

Feed bridge connector through center hole of LED board and carefully insert into 2-pin block. Gently push excess wire behind light plate and place LED board flat with cutouts positioned over screw holes.

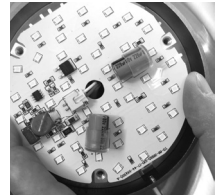
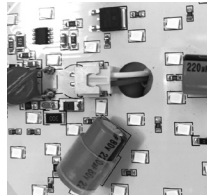

Align LED cover with cutouts in LED board and screw holes in light plate. Use short panhead screws to secure LED cover and LED board to light plate.

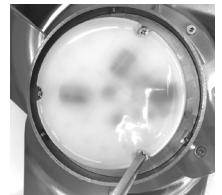

## Fan Installation *(continued)*

See Page 2  
**WARNING**

**Circuit Breaker**  
**POWER OFF**

- 3** Carefully place fan facing down on packing foam (avoid damage to light if installed). Using blade screws and washers from hardware package, secure each of three blades to rotor arms.

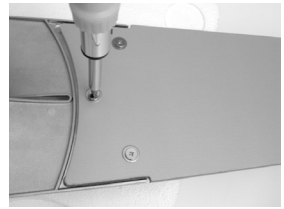

- 4** Remove stopper pin and half ball from small down rod by loosening set screw on half ball. Set parts aside for reinstallation in step (8).

**stopper pin**  
**set screw**

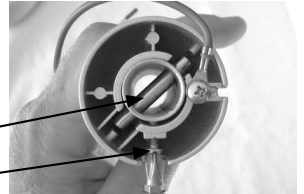

- 5** Remove the stopper screw and loosen the set screw on the fan collar. Set the stopper screw aside for step (6).

**stopper screw**  
**set screw**

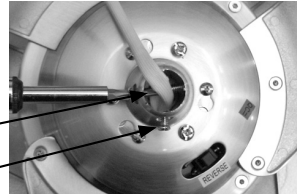

- 6** Run fan wires through selected down rod. Reinstall stopper screw from step (5) and firmly tighten set screw on fan collar against down rod.

**Note:** *If ceiling height allows, using a longer down rod will increase airflow and efficiency. However, blades must be at least 7 feet above the floor.*

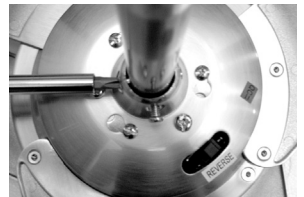

- 7** Slide fan canopy over down rod and carefully rest on top of fan body.

**canopy**

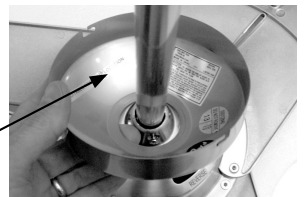

- 8** Reinstall half ball from step (4) on end of down rod. Be sure that stopper pin is inserted through down rod and seated in half ball. Tighten set screw against down rod.

**stopper pin**  
**set screw**

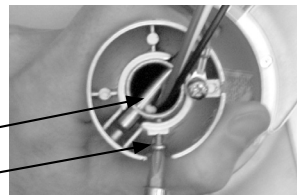

- 9 Using screws provided with junction box, securely attach hanging bracket to ceiling junction box. Junction box must be visibly marked as “Acceptable for Fan Support.” It is recommended that the flat washers and lock washers from the hardware pack be used for added security.



- 10 Lift fan to ceiling and set half ball in the hanging bracket so that the ridge on the edge of the hanging bracket is seated in the slotted channel in the half ball.

channel and ridge



- 11 With fan safely suspended by bracket, make wire connections with wire nuts included in hardware package as described in the **Control Installation Instructions (pages 8-11)**. If using optional #003, #004 or #005 controls, the receiving unit should be placed inside the arms of the hanging bracket and connected at this time. Install wall control as described in the control installation instructions (not applicable if using a handheld remote only).

- 12 Remove set screws on the sides of the hanging bracket. Lift canopy to ceiling and align holes on sides with set screw holes on hanging bracket. Re-install and tighten set screws to hold canopy in place.

set screw



- 13 If optional LED is installed, position glass diffuser inside light cup and rotate until secure.

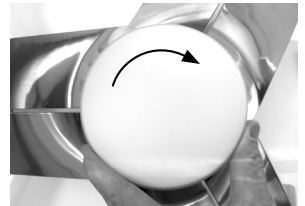

- 14 Your fan is reversible for summer and winter operation. The reverse switch is located on the top of the fan body. When reading the **REVERSE** label, the **LEFT** position is for summer and the **RIGHT** position is for winter.

reverse switch



- 15 The motor and blade arm assembly of your fan have been dynamically balanced prior to shipment. In addition, the blades have been matched to the nearest gram to ensure a well balanced ceiling fan. Furthermore, a blade balancing kit has been included with your fan. Please refer to the instructions packaged with the balancing kit should your fan require additional balancing.

# Control Installation and Wiring

When ordering your fan, you should have selected the control that was most appropriate for your fan, electrical requirements and desired functionality.

Controls are intended for use with one fan (except #FC-009A/009B as noted).

## Control Options



### #FC-001 Fan Speed Control

A basic fan control used to operate one fan only, providing four speeds.

*Not compatible with remote control.*



### #FC-004-LED Two Wire Fan Speed & Light Control

Designed for independent operation of a fan and light using only one circuit (two wires). Provides three speeds and full range dimming (or "on/off" switching) and wires into wall box. Includes wall switch, switch plate and receiver.



### #FC-002 Three Wire Fan Speed & Light Control

For operation of one fan with light. Requires two circuits (three wires). Provides three speeds and dimming of light.

*Not compatible with remote control.*



### #FC-005-LED Two Wire Wall Control with Remote Handset

A combination control set providing three speeds and full range dimming (or "on/off" switching) from wall control and/or remote handset. Includes one receiver, a remote handset with hanging bracket, two AAA batteries and wall control with switch plate.



### #FC-003-LED Handheld Remote Control

Designed for independent operation of a fan and light using only one circuit (two wires). Provides three speeds and full range dimming (or "on/off" switching). Includes handset, receiver, two AAA batteries and comes with a wall hanging bracket for handset.



### #FC-009A/009B Multi-Fan Control

*(sold separately from fans)*

A three speed fan control designed to control two fans (#009A) or three to five fans (#009B) on a single circuit. Separate control/switching of lights must be planned if this control is to be used for fans with lights. For AC motors only.

*Not compatible with remote control.*

See Pages 2-3  
**WARNING**

**WARNING!!** Power must be disconnected at circuit breaker prior to any contact with electrical wires.

## Wiring

With power turned off at breaker, make wire connections from the fan to the power supply at the ceiling and from the control to power at wall box as shown in the wiring diagrams below.

**Note:** For #FC-009A or #FC-009B, refer to printed instructions included in control box/packageing.

### #FC-001 Wiring Diagram

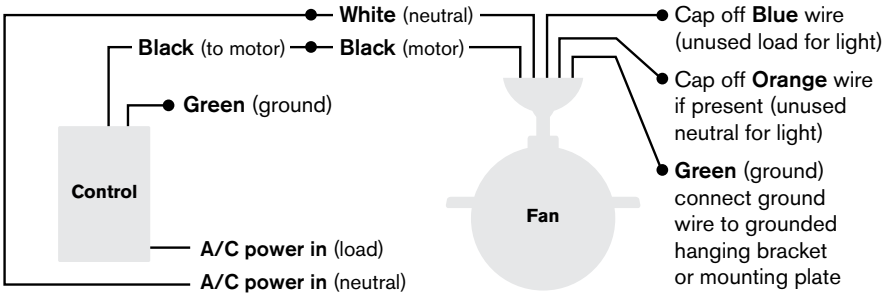

### #FC-002 Wiring Diagram

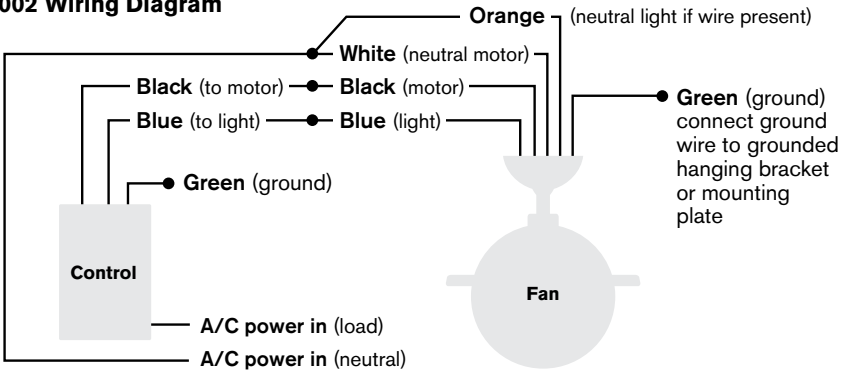

### #FC-003/#004/#005 Wiring Diagram

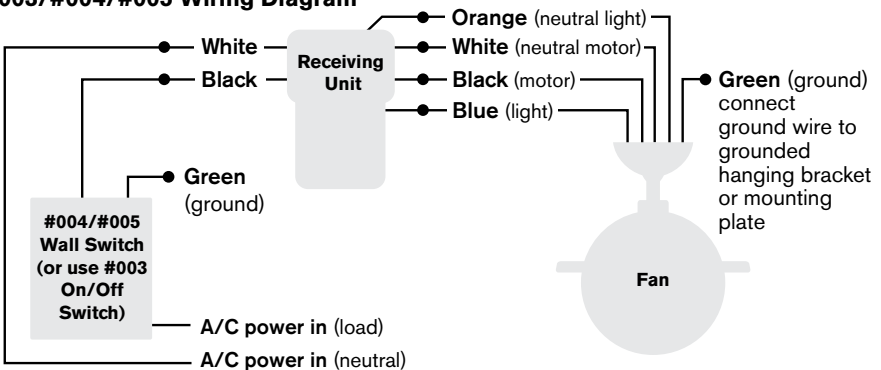

## Receiving Unit Wiring Detail (for #003, #004 and #005 only):

With fan suspended from ceiling and with power off at breaker box, make wire connections as shown below.

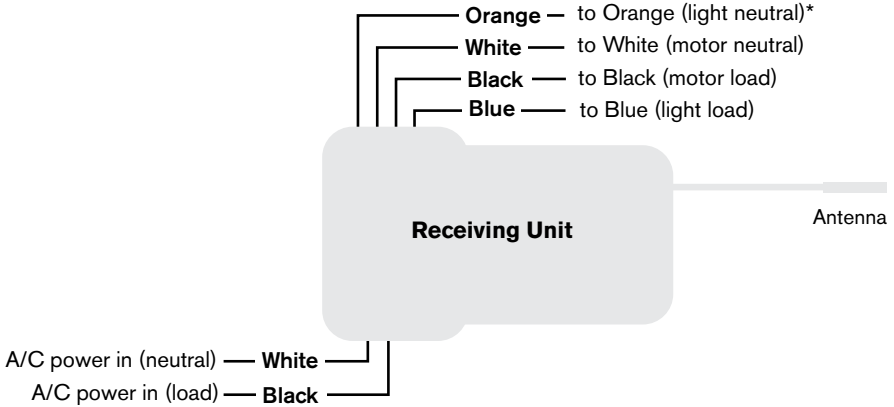

\* If fan does not have orange wire, cap orange wire from receiving unit.

## Receiving Unit Placement

The receiving unit sits in the hanging bracket as shown below. While there is ample room for the receiving unit as shown here, the wires can sometimes become difficult to manage in the space available. Trimming excess wire before making connections can ease wire management.

**Tip:** Splicing lighter gauge wire to the power supply and positioning the heavier wires up into the junction box can also ease wire management.



## Dimming Selector Switch (for #003, #004 and #005 only):

The remote handset (#003/#005) and wall control (#004/#005) ship pre-set for “on/off” operation of the light. The **LIGHT** button will turn the light on and off when pressed and released.

To enable dimming function on the remote handset, move the vertically oriented dip switch down from ON to 1 (or from X to D). On the wall control, move the right (or lower) dip switch from ON to 2 (or from X to D). Dip switches are located inside the battery cover of the remote handset and on the left side of the wall control. See image below.

With dimming enabled, pressing and holding the **LIGHT** button will increase or decrease brightness, stopping at the minimum and maximum brightness levels or when the **LIGHT** button is released.

### Dip Switches:

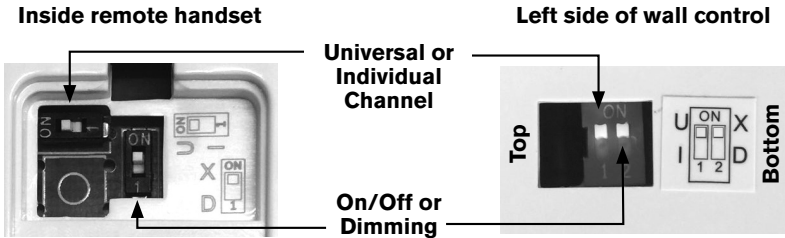

## Universal or Dedicated RF Channels (for #003, #004 and #005 only):

The remote handset (#003/#005) and wall control (#004/#005) ship pre-set to a “Universal” or common RF channel. If you have multiple fans in close proximity, you will want to set the remote handset and/or wall control to an “Individual” (or unique) channel. To select the “Individual” channel on the remote handset, move the horizontally oriented dip switch from ON to 1 (or from U to I). On the wall control, move the left (or upper) dip switch from ON to 1 (or from U to I). See images above.

## Device Pairing

If using the individual RF channel(s), you will need to pair your remote handset and/or wall control with the receiver. Begin by turning power off at the wall control, at the main switch leg, or at the circuit breaker if there is no wall control or on/off switch in use. Switch the power supply back on and immediately press and firmly hold down the **LIGHT** and **FAN OFF** buttons simultaneously for 10 seconds. If using both a remote handset and wall control with a fan, repeat these pairing steps with the second device. If using a handset or wall control only, repeat the pairing steps again with that device. This “pushes out” the Universal code from the receiver memory and will avoid interference from any nearby controls set to the Universal channel.

# Troubleshooting

**Please read all installation instructions carefully.** After reviewing the following troubleshooting tips, if you are unable to solve a problem with the installation or operation of you fan, please contact customer service for additional assistance.

**IMPORTANT: Do not return a fan or fan parts without first contacting us for troubleshooting assistance.**

If we are unable to resolve a problem over the phone, a replacement fan or part will be provided and a prepaid shipping label will be issued for returning the defective product. Returns cannot be accepted without a Company issued return label.

For the return of non-defective, un-installed merchandise, please contact your dealer.

Often, noises such as ticking or humming can be caused by loose parts or structural factors in the ceiling. Please double check that all screws and parts are firmly tightened, including the outlet box from which the fan is hung. Next, review the troubleshooting tips listed below.

As stated in the warranty, Modern Fan Co. is not liable for costs incurred related to installation labor or equipment. Be sure to test all functions of your fan, and if need be, contact customer service while your contractor/electrician is still on site.

---

## Troubleshooting Checklist

### **Blades don't turn...**

- Check that the reverse switch is firmly in one position (Forward or Reverse).
- Check wire connections at ceiling and wall control.
- Verify that there are no physical obstructions preventing motor & blades from spinning (push blades by hand to confirm that they spin freely).
- Confirm power has been turned on at circuit breaker and wall switch.

### **Light doesn't work in the on position...**

- Check wire connections at ceiling and wall control.
- Be sure lamp is screwed in completely so that base touches contacts or if equipped with a flat LED board, confirm that wire terminals are properly connected.

### **Fan wobbles...**

- Make sure hanging bracket and mounting hardware at ceiling is secure and firmly fastened.
- Be sure ridge in hanging bracket is seated in the half-ball slot.
- Check that stopper screw (or stopper pin) and set screws are firmly tightened where down rod is attached to the fan body.
- Remove and reinstall two blades in opposite positions.
- Use blade balancing kit as instructed.

*Note: blade sets should not be inter-mixed as they are weight matched when packaged together.*

**Fan makes repetitive ticking noise...**

- Check for obstructions in rotor path.
- Make sure mounting hardware at ceiling is secure.
- Make sure all other hardware and blade attachments are tight.
- Give fan adequate “break in period” of several hours to several days then repeat steps above.

**Fan makes humming noise...**

- Be sure you are using a fan speed control with specific speed settings. Rheostats or continuous dimmers will cause motor noise.
- Be sure that all fittings (light kit, bottom dome, canopy, etc.) are firmly secured. Loose parts will often cause vibrational noise or humming. Removal and re-attachment can sometimes remedy such resonant vibrational noise.

**Fan (or light) not responding to hand-held remote or wall mounted RF signal...**

- Check that all wire connections are secure and made as instructed.
- Verify that power is on and reaching the receiver (using a voltmeter).
- Review and repeat pairing instructions.
- Be sure to firmly press the center area of the buttons on you handset or wall control.
- Verify that batteries are installed with proper polarity as indicated inside battery cover.

**Unable to operate fan and light independently...**

- Be sure you are using a control designed for a fan with light.
- Verify that wire connections at ceiling and wall are made as instructed.

---

**Customer Service**

Monday–Friday, 8am–4pm (PST)

tel 888-588-3267

info@modernfan.com



# Maintenance



Before servicing or cleaning your fan, switch power off at service panel and lock the service disconnecting means to prevent power from being switched on accidentally. When the service disconnecting means cannot be locked, securely fasten a prominent warning device, such as a tag, to the service panel.

- Your fan uses maintenance free, sealed bearings. There is no need to lubricate the motor bearings or inner shaft.
- It is recommended that you inspect your fan at least annually to confirm that all blade screws and mounting hardware remain securely fastened as when originally installed.
- Periodic surface cleaning may be necessary depending on the amount of dust and particulate accumulation on the blades and surfaces of your fan. Use a damp cloth. If necessary, a light, non-abrasive soap solution may be used.
- If installed in a coastal, humid environment, regular surface cleaning may be necessary in order to avoid deterioration or oxidizing effects of salt or other corrosive elements. A Damp Location rating is not an assurance of finish durability. Preventative measures should be taken dependent on the environmental exposures your fan will undergo in order to preserve and protect the finish quality and appearance of your fan.
- If a wobble develops over time, you may need to rebalance your fan following the instructions that were included with the balancing kit. If the blades have warped, twisted, bent or become uneven in weight distribution, replacement blades may be the best course of action and can be purchased by contacting The Modern Fan Co. directly.
- If a noise develops over time (clicking, ticking, humming or otherwise), refer to the troubleshooting section of this manual (pages 12-13). If you are unable to remedy the issue, contact Modern Fan customer service for further assistance.

Use this unit only in the manner intended by the manufacturer. If you have any questions contact The Modern Fan Co.

---

## Customer Service

Monday–Friday, 8am–4pm (PST)

tel 888-588-3267

info@modernfan.com



# Lifetime Limited Warranty

All products manufactured and sold by The Modern Fan Co. meet the highest industry standards. We use only the finest materials and production processes resulting in quality ceiling fans backed by the following warranty:

Motors (dry locations):.....	Lifetime
Motors (damp locations): .....	10 years
Light Kits:.....	3 years
Component Parts (switches, capacitors, blades): .....	1 year
Finishes: .....	1 year
Wall and remote controls:.....	1 year

## Limitations:

- This warranty covers failure of fan due to defect(s) in materials or workmanship and does not apply to defects, malfunctions or failures which are caused by repairs by persons not authorized by us, use of parts or accessories not authorized by us, mishandling, improper installation, modifications or damage to the fan while in your possession, or unreasonable use.
- This warranty applies only to products sold and installed within the United States.
- This warranty extends only to the original user or consumer purchaser of the ceiling fan.
- This warranty applies to private residential use of ceiling fans only. Use of products in commercial applications is backed by a 10-year “motor” warranty. All other aspects of this warranty remain the same.
- This warranty only covers the replacement or repair of ceiling fan or parts as specified above, and does not cover any other costs incurred related to installation labor or equipment, or shipping of fan or fan parts.
- No other expressed warranty is given. The repair or replacement of a product is your exclusive remedy. Any implied warranty of merchantability or fitness is limited to the duration of this written warranty. In no event shall the Company be liable for consequential or incidental damages. Some states do not allow exclusion or limitation of consequential or incidental damages, so the above exclusions or limitations may not apply to you.

## Claims:

Prior to submitting a claim for a defective or failed fan, or prior to removal of your fan from its installation location, please contact customer service (888-588-3267) for troubleshooting assistance. Often our personnel can diagnose the cause of a nonfunctioning fan and provide either operational instructions, or replacement parts/components that don't require your fan be removed from the ceiling.

If we are unable to remedy the problem in this way, upon receipt of proof of purchase (including date and location of sale), we will provide the necessary replacement parts or fan as specified by this warranty, or provide instructions and an authorization for return of the product for diagnosis, repair or replacement.



**The Modern Fan Company, Inc.**

709 Washington Street, Ashland, Oregon 97520

tel 888-588-3267, fax 541-482-8418

[info@modernfan.com](mailto:info@modernfan.com)

[modernfan.com](http://modernfan.com)

*be* ORIGINAL™  
Member