

Ax1

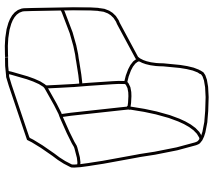

Bx2

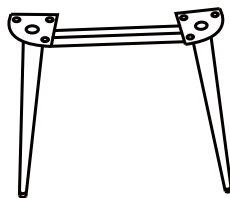

Cx12

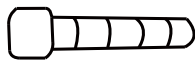

Dx1



1

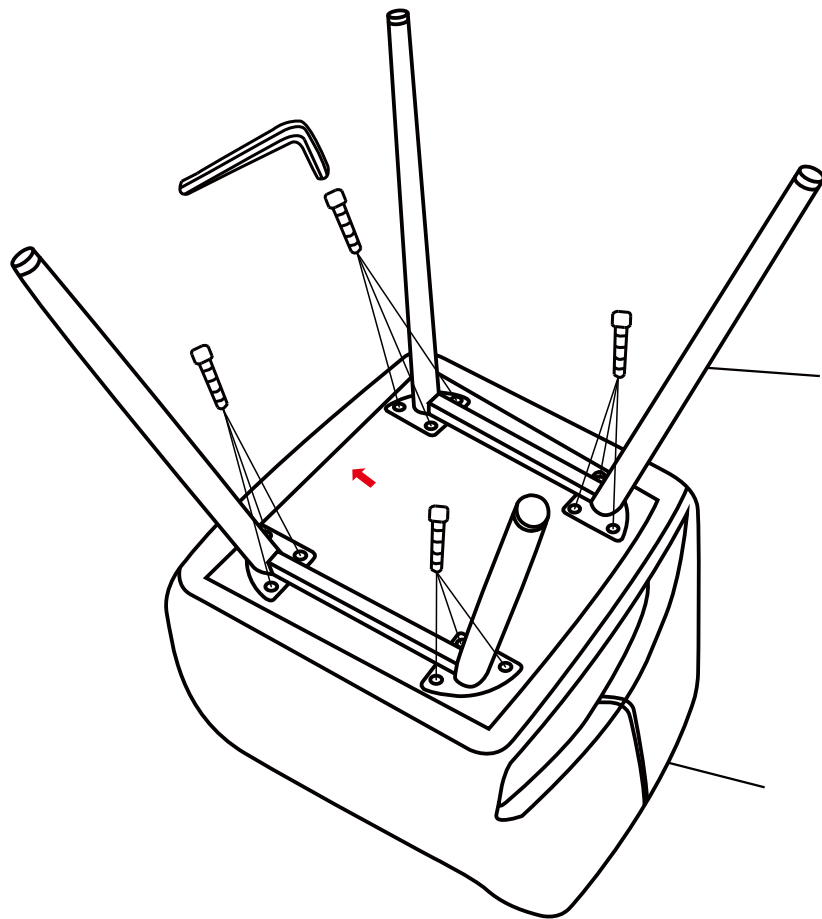

2

