

Iron Vertical Back Dining Room Swivel Chair

Assembly & Care instructions

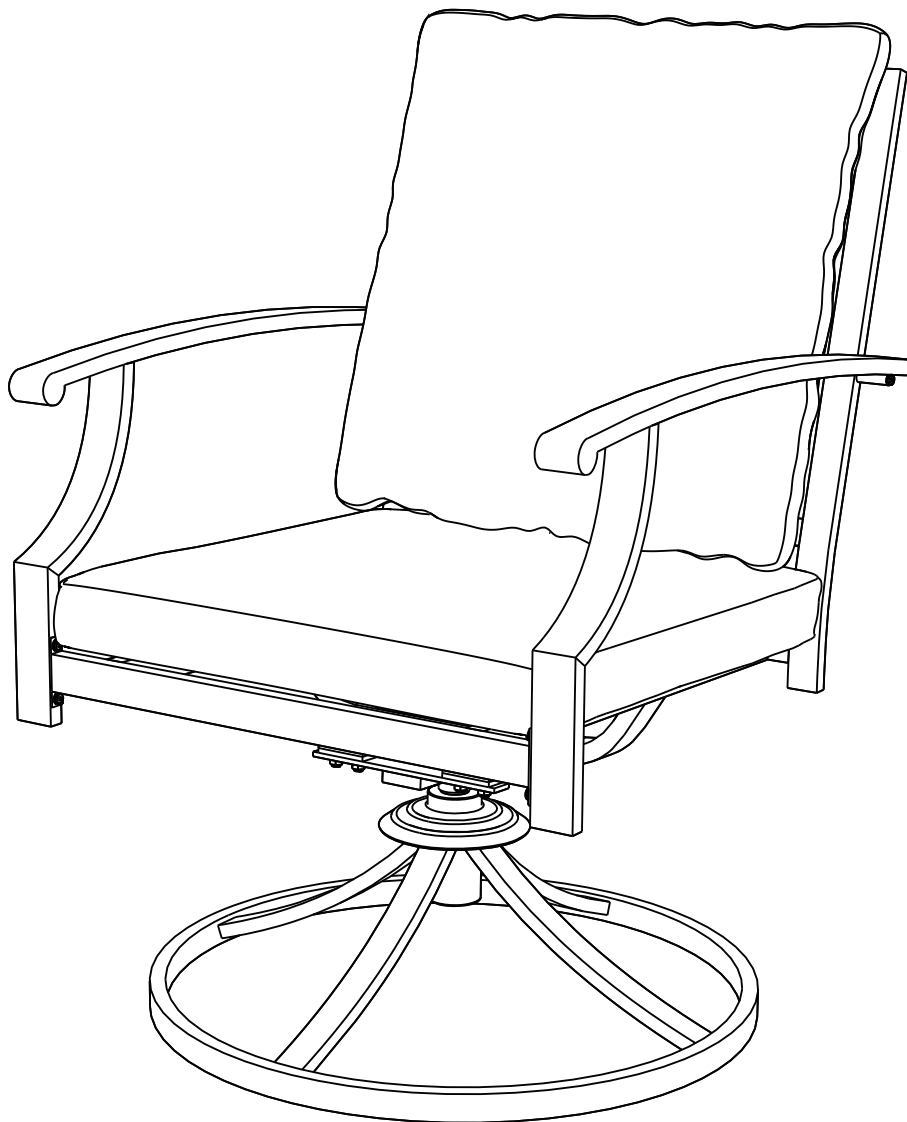



Please read & retain for future reference

Care & Instructions

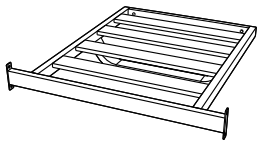
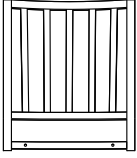
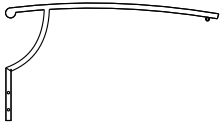

Thank you for ordering this outdoor dining furniture set. Here are some suggestions that may help you:

1. This set of outdoor Iron vertical back dining room swivel chairs has two in a box.
2. The mat is vacuum-packed. After opening the package, the mat will become thick enough after a period of time.
3. If any parts are damaged or lost, please read this instruction carefully (refer to the parts list on page 4 through page 6), please feel free to contact us. We will send you a replacement immediately.
4. In order to prolong the service life of sofa cover, we suggest that you put all cushions indoors in rainy days.
5. We hope you can like our products, if you have any other questions, please contact us.

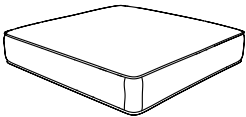
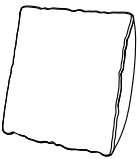
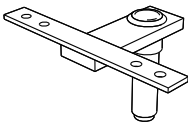
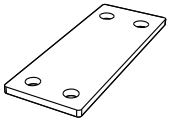
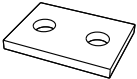
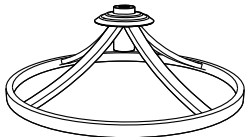
PARTS LIST

Part	Description	Part Name	Qty
A		Seat Plate Part	2
B		Back Plate Part	2
C		Right Armrest Part	2
D		Left Armrest Part	2
E		Seat Cushion	2
F		Back Cushion	2
G		T-shaped metal parts	2
H		Spring Steel	4
I		Spring Tabs	8
J		Bottom Turntable	2

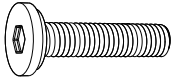
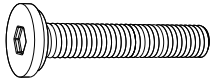
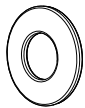
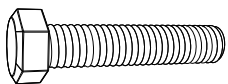
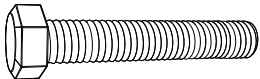
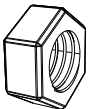
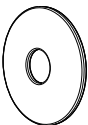
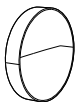
Screw Set List

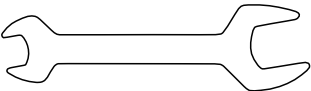
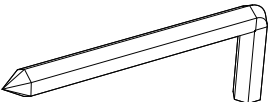
Part	Description	Part Name	Qty
K		Bolt M6 × 20	8PCS
L		Bolt M6 × 30	10PCS
M		M6 Gaskets	16PCS
N		Bolt M8 × 25	8PCS
O		Bolt M8 × 30	8PCS
P		Jam Nuts M8	16PCS
Q		M6 Large Gaskets	2PCS
R		Bolt Cap	16PCS
S		M8 Gaskets	16PCS
T		Retaining Ring	16PCS
U		Wrench	2PCS
V		Allen wrench M6	1PC

Screw Set List

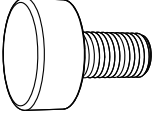
Part	Description	Part Name	Qty
W		Hexagon Bolt Cap	16PCS
X		Footrest	12PCS

Extra

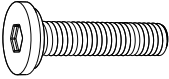
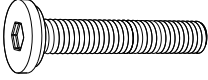
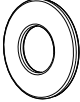
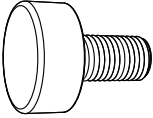
Part	Description	Part Name	Qty
K		Bolt M6 × 20	2PCS
L		Bolt M6 × 30	2PCS
M		M6 Gaskets	4PCS
X		Footrest	2PCS

WARNING: Failure to locate parts in accordance with these diagrams, or failure to use special parts provided with this equipment, may result in property damage or personal injury.

SPECIFICATIONS

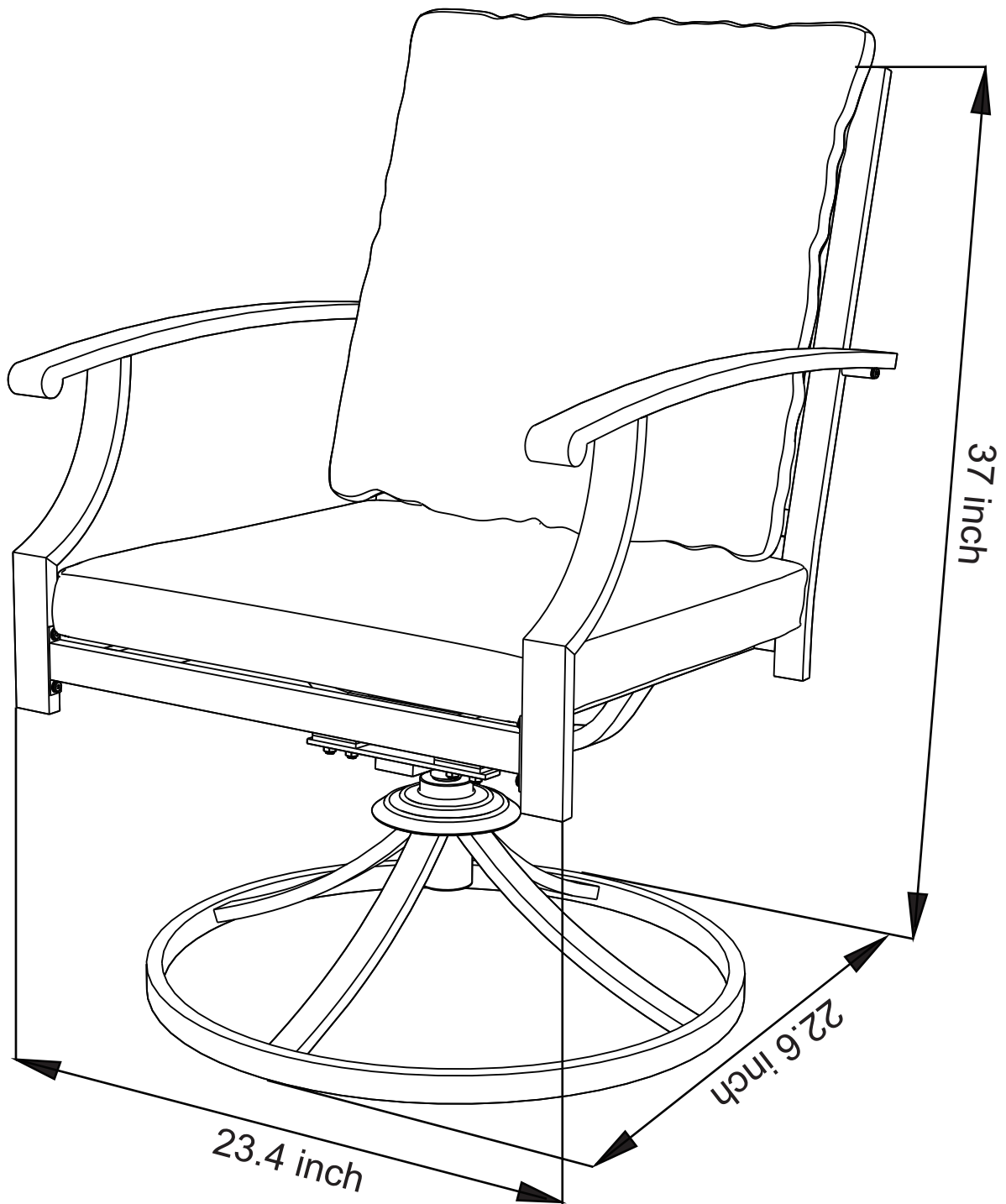

Step 1

Align the two holes on the rear side of the Seat Plate Part (A) with the Back Plate Part (B) and secure with Bolts (L) to the M6 Gaskets (M).

Note: Do not tighten the Bolt.

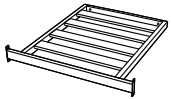
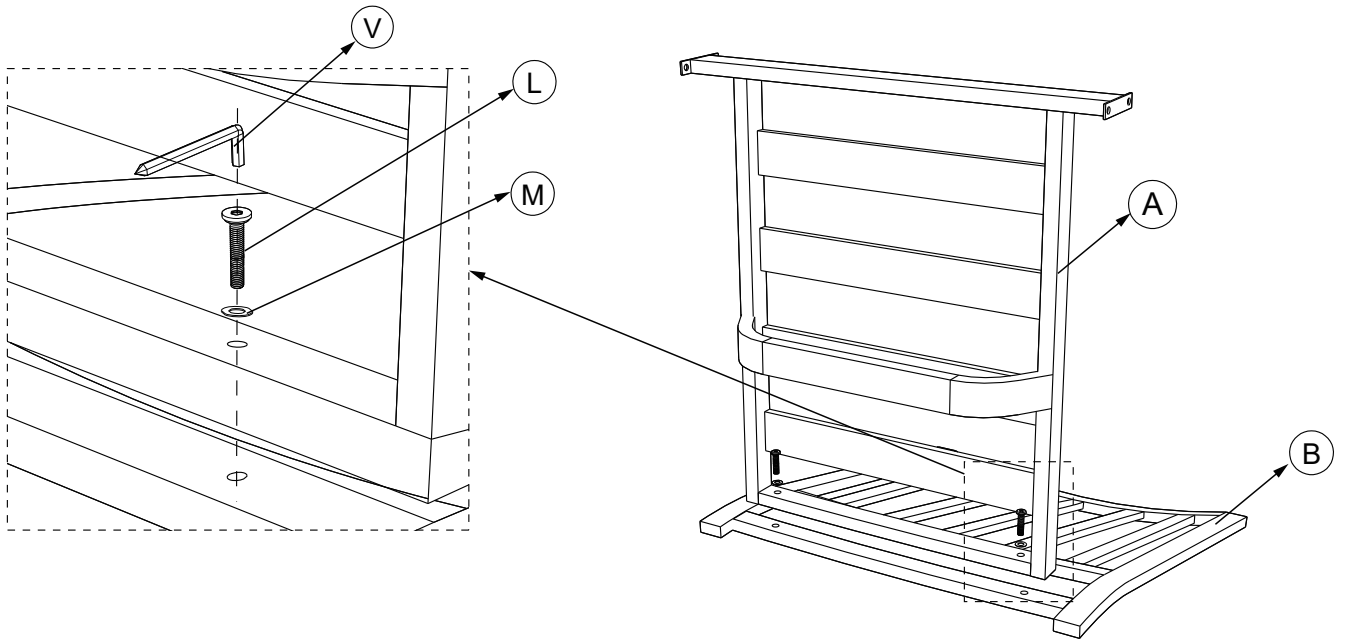

A×2

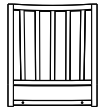

B×2

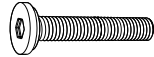

L×4



M×4

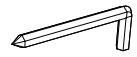

V×1

Step 2

Fit Right Armrest Part (C) to the right side of assembly (AB), with the two holes on the inside of (C) aligned with the holes on the right side of (AB) and secured with Bolts (K) and M6 Gaskets (M).

Note: Do not tighten bolts.

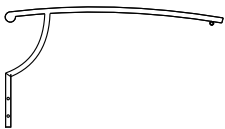
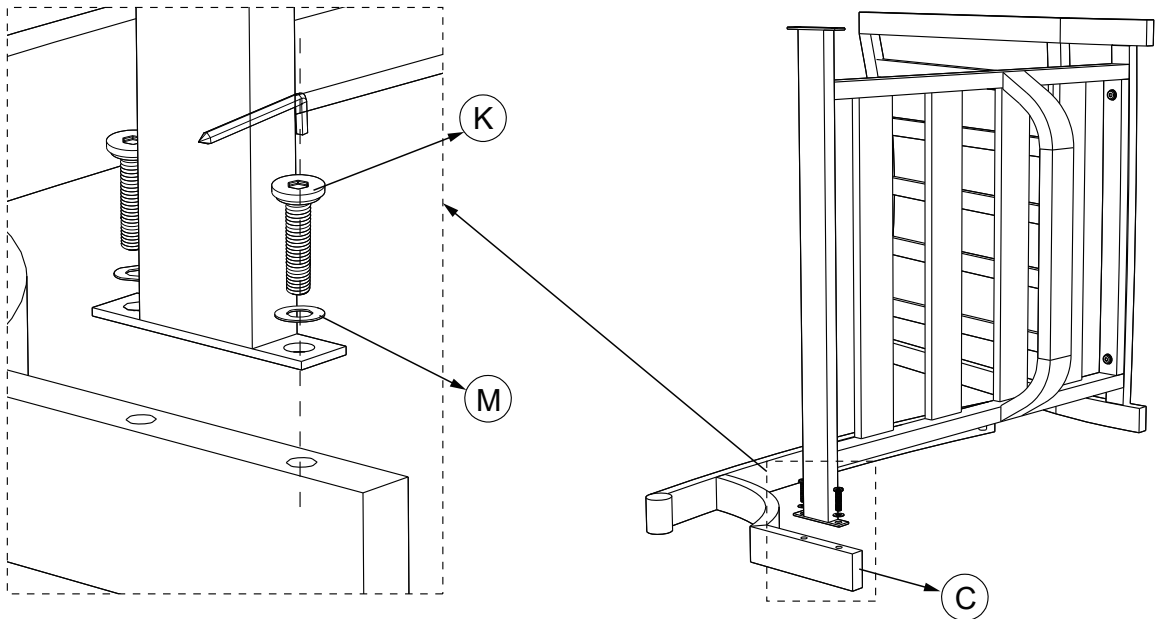

C×2

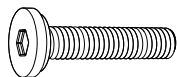

K×4



M×4

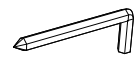

V×1

Step 3

The Left Armrest Part (D) is fitted in the same way as Step 2.

Note: Do not tighten the Bolt.

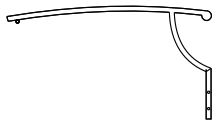
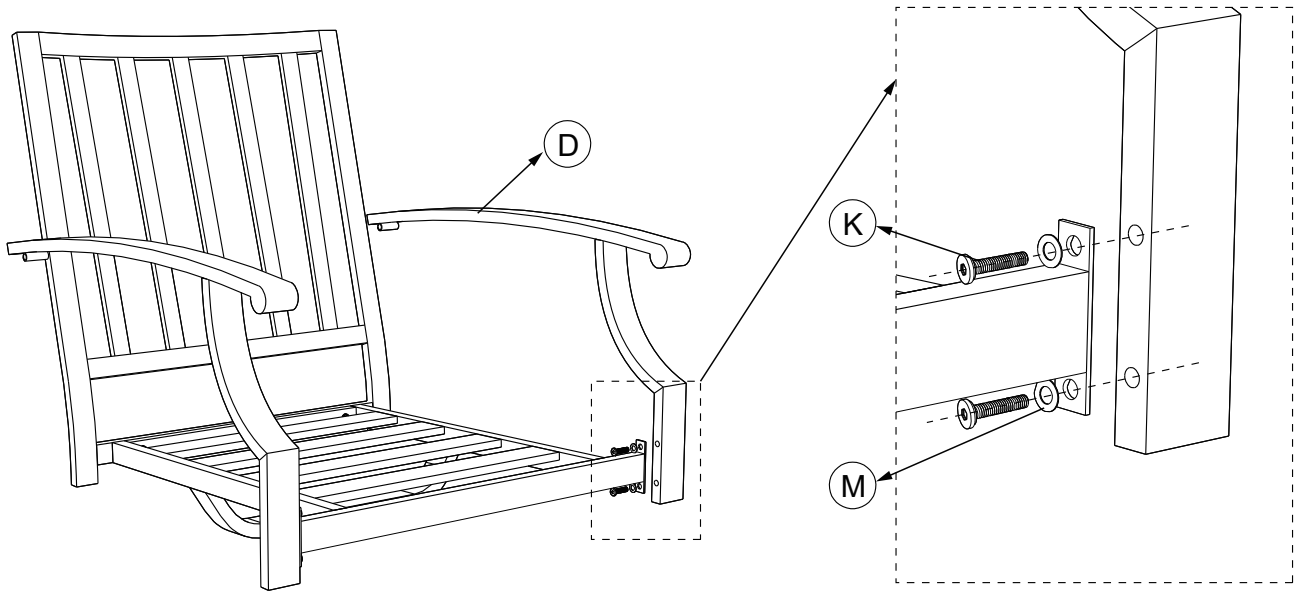

D×2

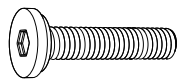

K×4



M×4

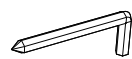

V×1

Step 4

Align the outer holes of the armrests on both sides with the outer holes of (B) and secure using Bolts (L) with M6 Gaskets (M).

Note: Tighten bolts at this time.

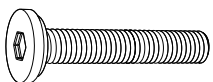
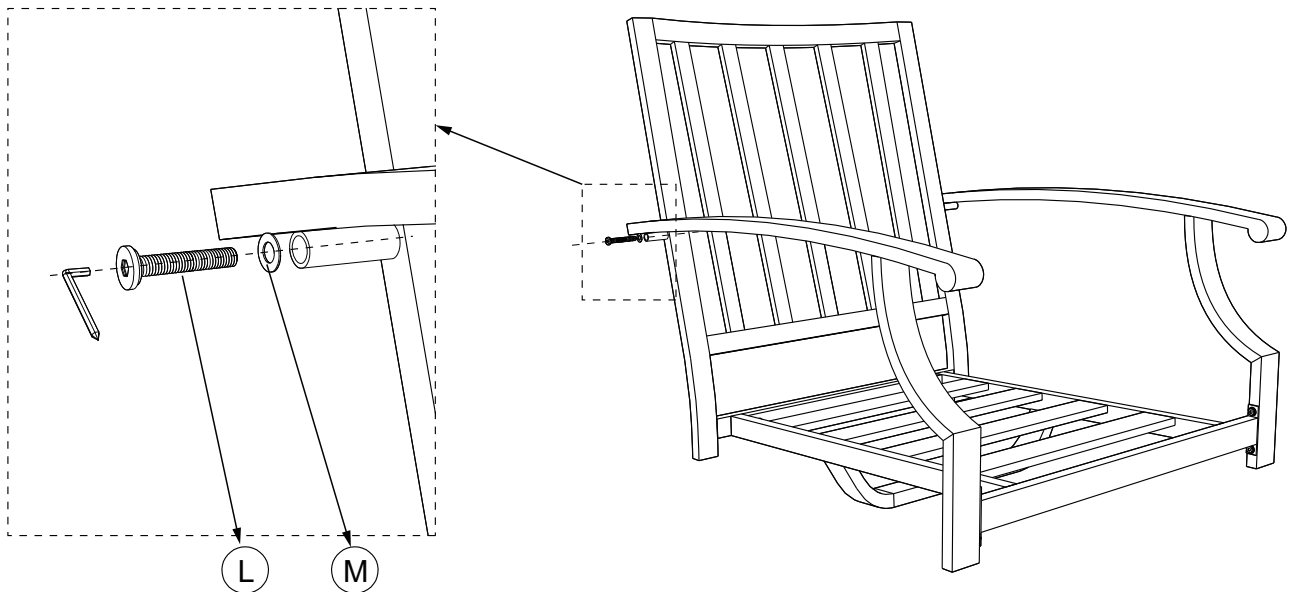

L×4



M×4

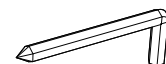

V×1

Step 5

Assemble the T-shaped Metal Parts (G), Spring Steel (H), and Spring Tabs (I) in the order shown, and thread a Bolt (O) through the Retaining Ring (T) and M8 Gaskets (S) as shown, locking it in place with the jam nut (P) underneath.

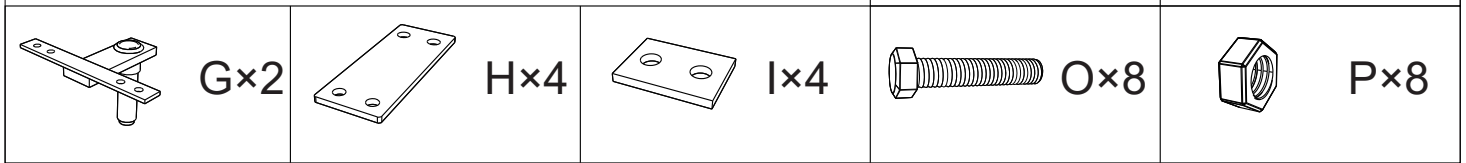
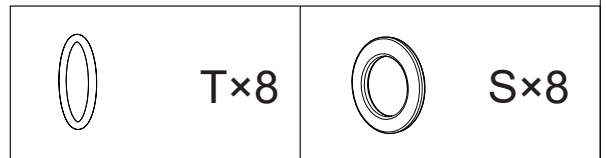
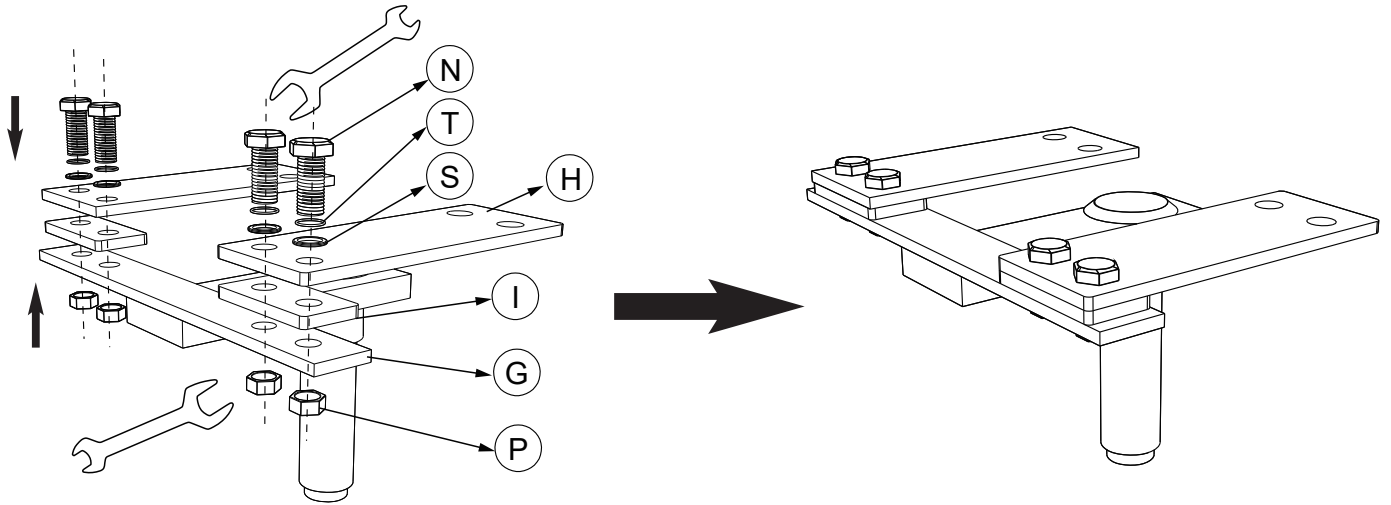

Step 6

Insert the Metal Part (GHI) into the Bottom Turntable (J) and tighten the Bolt (L) through the M6 Large Gaskets (Q) and lock it into the Metal Part (GHI) as shown.

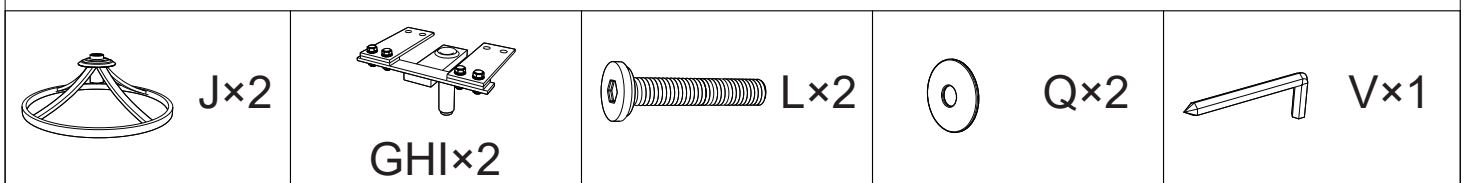
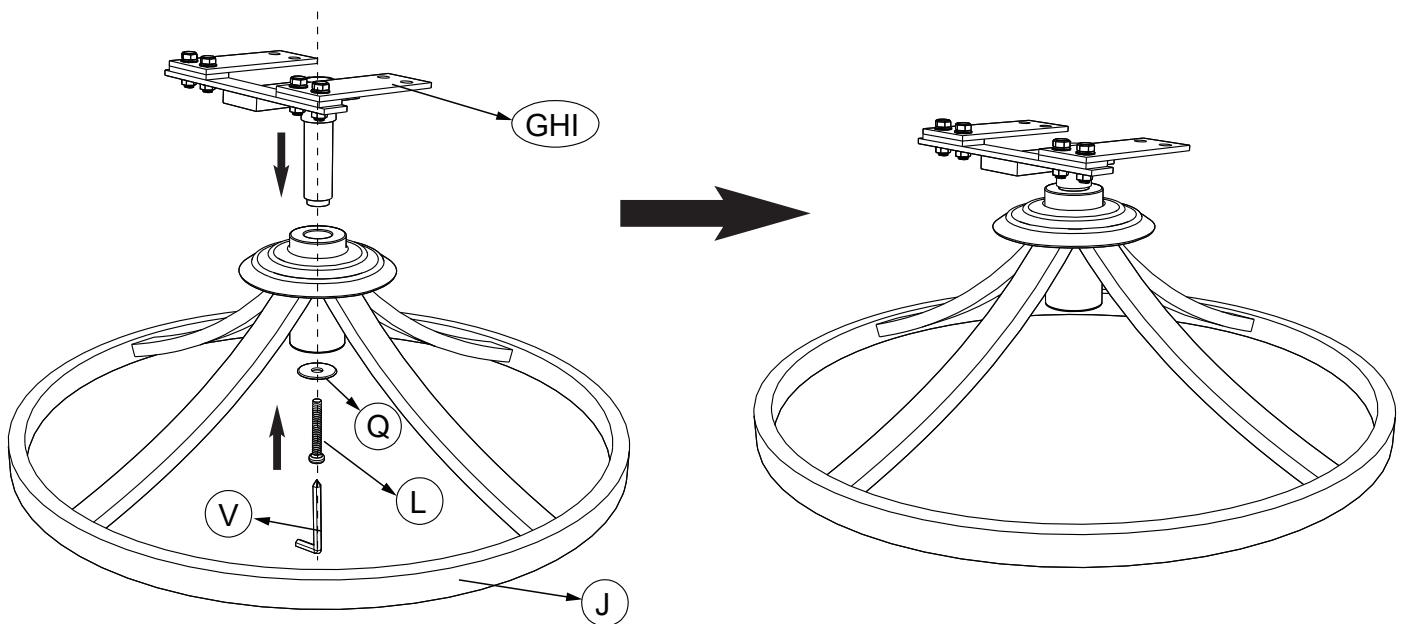

Step 7

Combine the upper and lower parts, align the lower holes in (A) with the holes in (GHI), install the Spring Tabs (I), the Blot (N), the M8 Gaskets (S), the Retaining Ring (T), and the Jam Nut M8 (P) in the order of the way, and tighten the bolts and nuts with the Wrench (U).

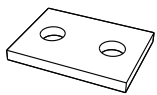
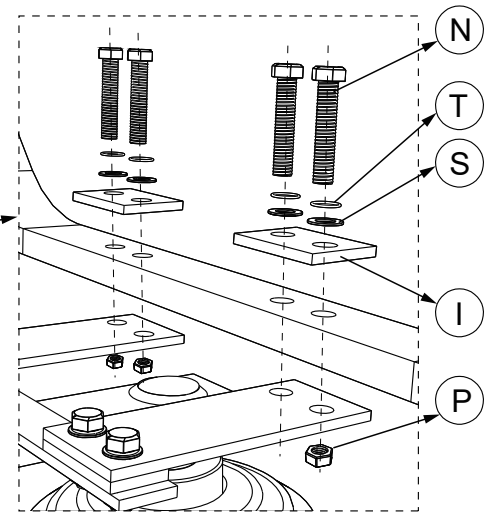
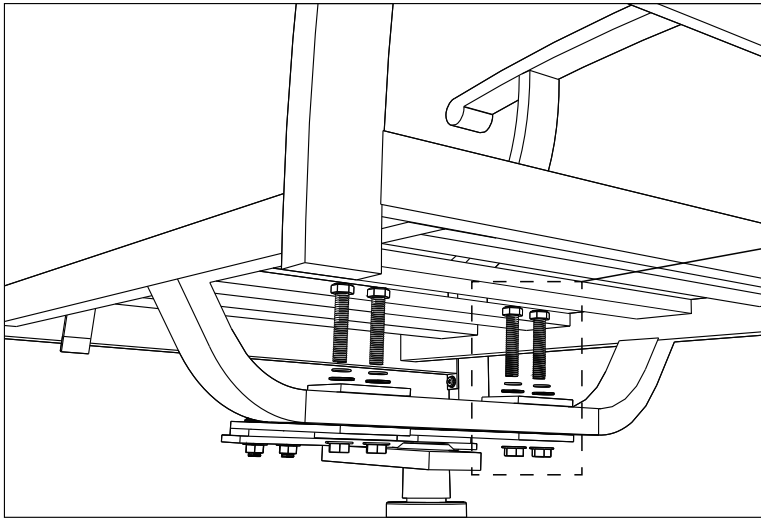

I×2

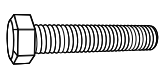

N×8



S×8



T×8



P×8

Step 8

Finally turn the cushion over, there will be four velcro straps, after placing the Cushion(E) on the seat plate, wrap the velcro around the slats as shown and finally tighten.

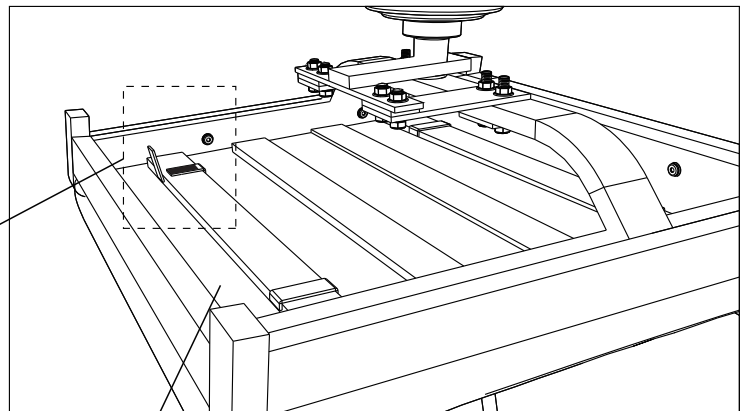
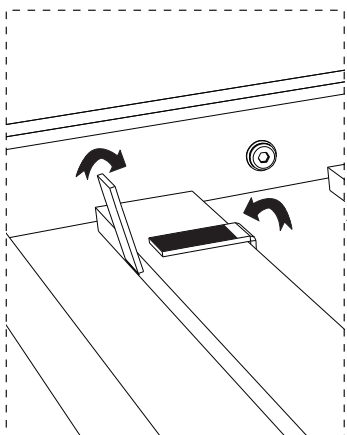
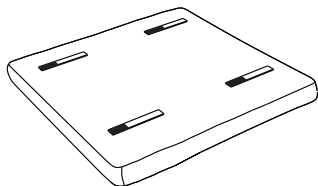

H

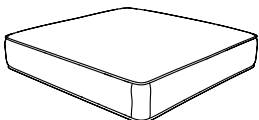

E×2

Step 9

Put all bolt caps(R&W) on the bolts.
Finish by placing the Back Cushion(F) in the chair.

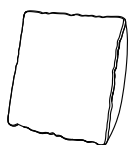

F×2

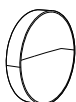

R×2



W×2

WARM WINTER SET: This product can be paired with our store's Outdoor square table heater, so that your winter is no longer cold and you can enjoy a warm winter outdoor afternoon tea.

ENSEMBLE CHAUD POUR L'HIVER : Ce produit peut être associé au chauffage de table carré pour l'extérieur de notre magasin, de sorte que votre hiver ne soit plus froid et que vous puissiez profiter d'un thé d'après-midi chaud en plein air.

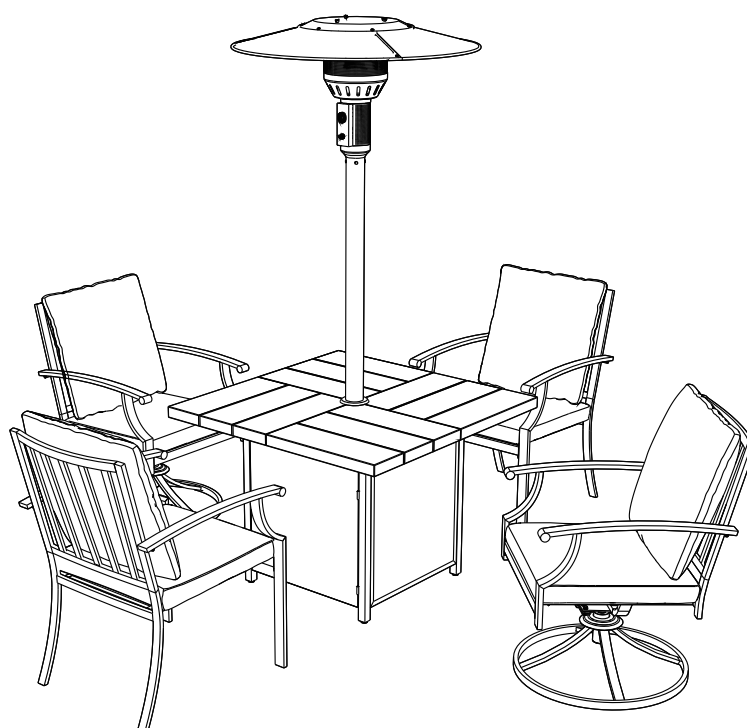

Chaise de salle à manger pivotante à dossier vertical en fer

Instructions de montage et d'entretien

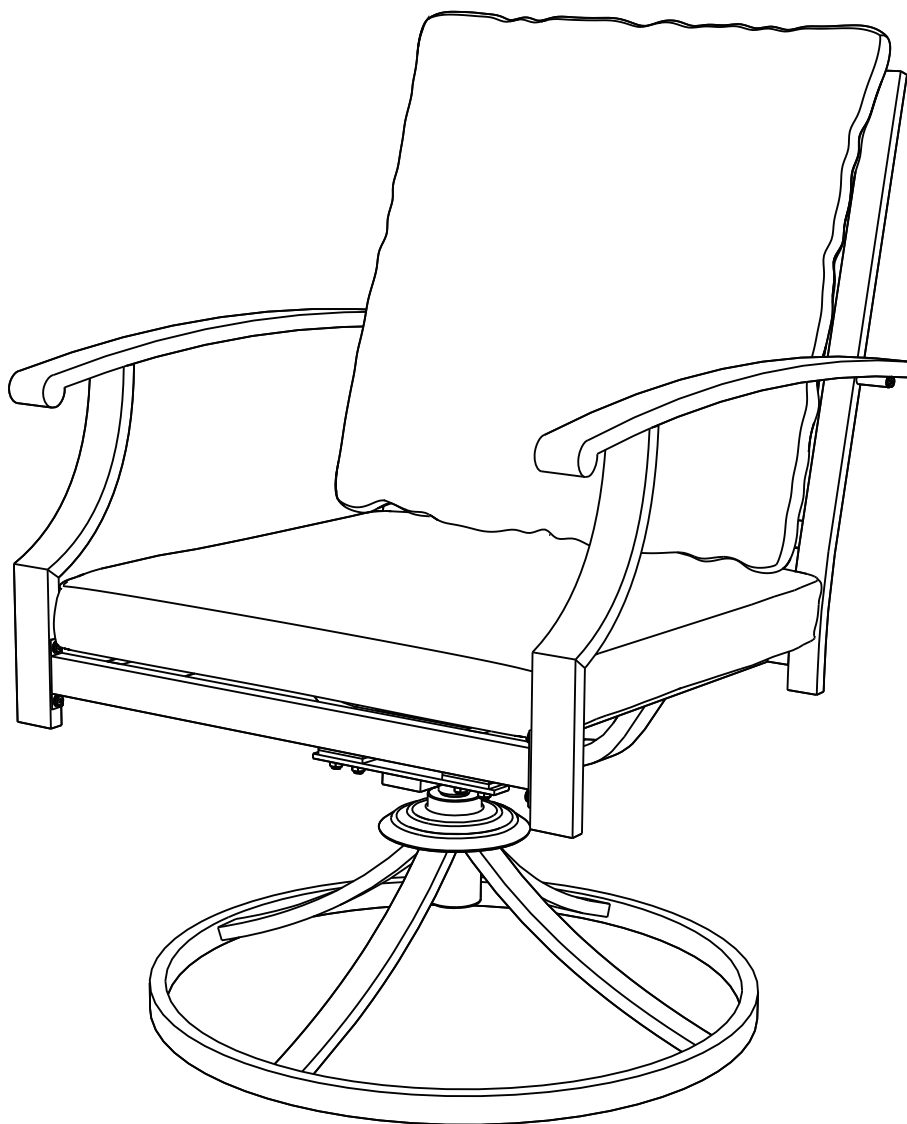





À lire et à conserver pour référence ultérieure

Soins et instructions

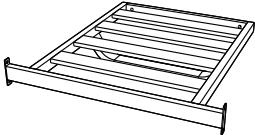
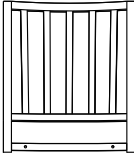
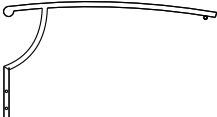

ous vous remercions d'avoir commandé cet ensemble de meubles de salle à manger pour l'extérieur. Voici quelques suggestions qui pourraient vous aider :

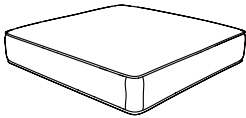
1. Cet ensemble de fauteuils à bascule en fer tricoté pour l'extérieur est livré par deux dans une boîte.
2. Le tapis est emballé sous vide. Après ouverture de l'emballage, le tapis deviendra suffisamment épais au bout d'un certain temps.
3. Si des pièces sont endommagées ou perdues, veuillez lire attentivement ces instructions (se référer à la liste des pièces de la page 4 à la page 6), n'hésitez pas à nous contacter. Nous vous enverrons immédiatement un produit de remplacement.
- 4) Afin de prolonger la durée de vie de la housse de canapé, nous vous conseillons de placer tous les coussins à l'intérieur les jours de pluie.
5. nous espérons que vous aimerez nos produits, si vous avez d'autres questions, n'hésitez pas à nous contacter.

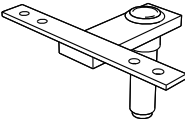
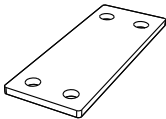
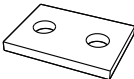
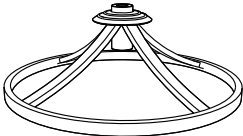
LISTE DES PIÈCES

Partie	Description	Nom de la pièce	Qté
A		Plaque de siège Pièce	2
B		Plaque arrière Partie	2
C		Partie de l'accoudoir droit	2
D		Partie gauche de l'accoudoir	2
E		Coussin de siège	2
F		Coussin de dossier	2
G		Pièces métalliques en forme de T	2
H		Acier à ressort	4
I		Languettes à ressort	8
J		Plateau tournant inférieur	2

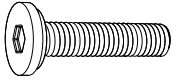
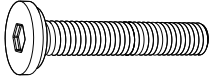
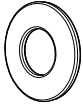
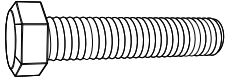
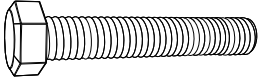
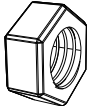
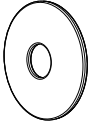
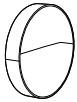
Liste des jeux de vis

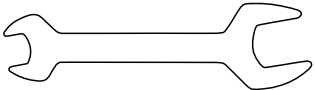
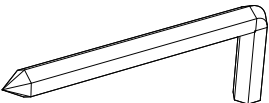
Partie	Description	Nom de la pièce	Qté
K		Boulon M6 × 20	8PCS
L		Boulon M6 × 30	10PCS
M		M6 Joints	16PCS
N		Boulon M8 × 25	8PCS
O		Boulon M8 × 30	8PCS
P		Noix de confiture M8	16PCS
Q		M6 Grands joints	2PCS
R		Capuchon de boulon	16PCS
S		M8 Joints	16PCS
T		Anneau de retenue	16PCS
U		Clé à molette	2PCS
V		Clé Allen M6	1PC

Liste des jeux de vis

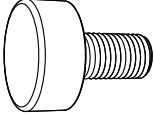
Partie	Description	Nom de la pièce	Qté
W		Capuchon de boulon hexagonal	16PCS
X		Repose-pieds	12PCS

Extra

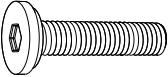
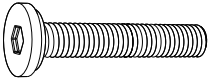
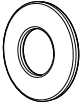
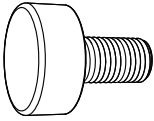
Partie	Description	Nom de la pièce	Qté
K		Boulon M6 × 20	1PC
L		Boulon M6 × 30	1PC
M		M6 Joints	2PCS
X		Repose-pieds	2PCS

AVERTISSEMENT : Le fait de ne pas localiser les pièces conformément à ces schémas ou de ne pas utiliser les pièces spéciales fournies avec cet équipement peut entraîner des dommages matériels ou corporels.

CARACTÉRISTIQUES TECHNIQUES

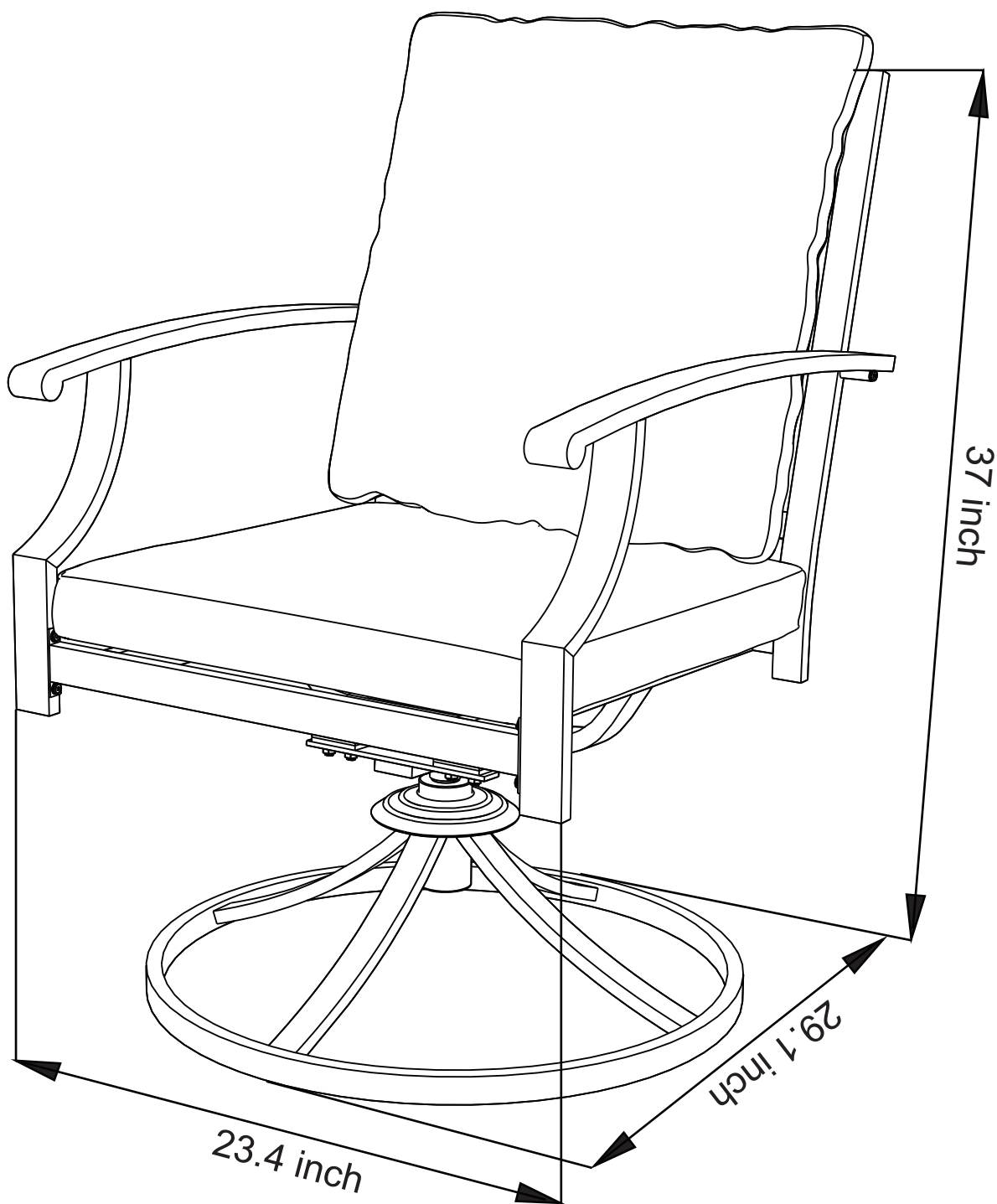

Step 1

Aligner les deux trous situés à l'arrière de la partie de la plaque d'assise (A) avec la partie de la plaque arrière (B) et fixer les boulons (L) aux joints M6 (M).
Remarque : ne pas serrer le boulon.

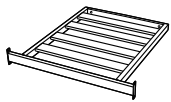
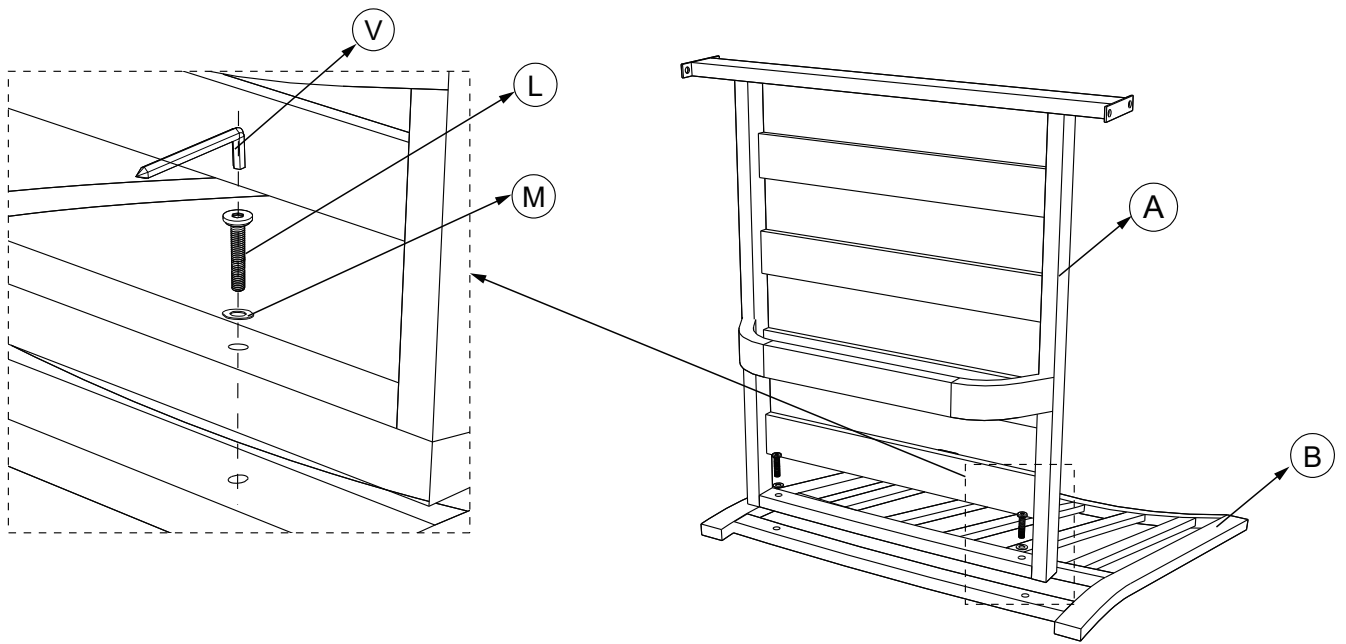

A×2

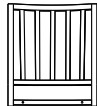

B×2



L×4



M×4

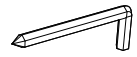

V×1

Step 2

Monter la partie de l'accoudoir droit (C) sur le côté droit de l'assemblage (AB), en alignant les deux trous à l'intérieur de (C) sur les trous du côté droit de (AB) et en la fixant avec des boulons (K) et des joints M6 (M).
Remarque : ne pas serrer les boulons.

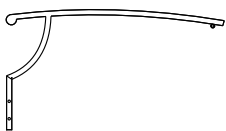
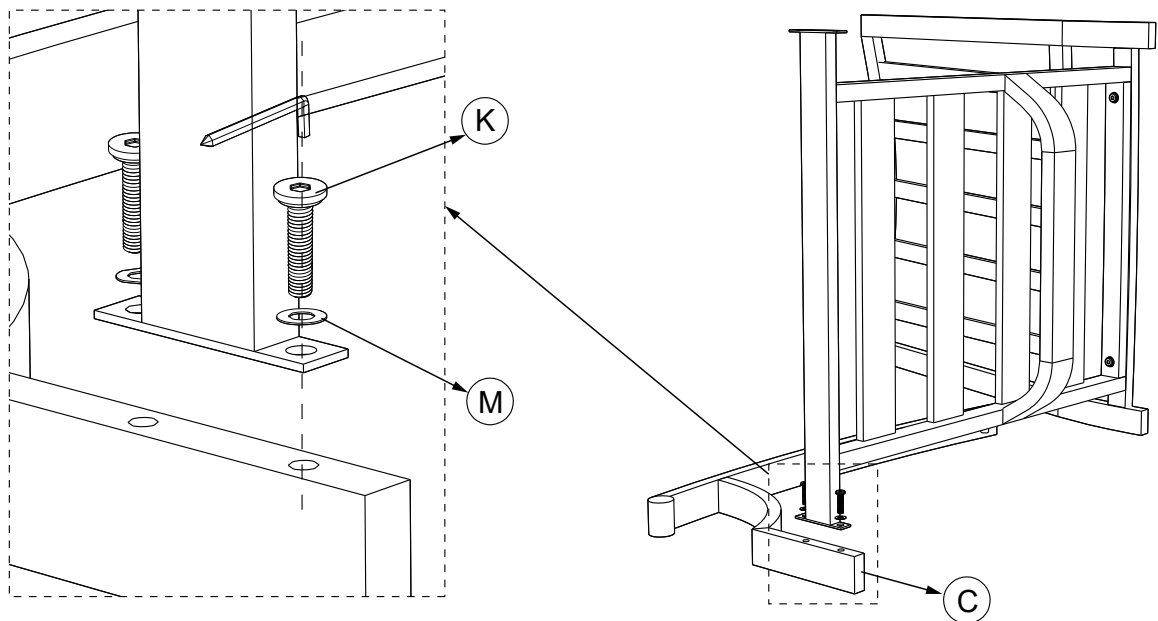

C×2

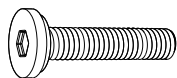

K×4



M×4

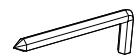

V×1

Step 3

La partie de l'accoudoir gauche (D) est montée de la même manière qu'à l'étape 2.

Remarque : ne pas serrer le boulon.

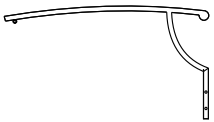
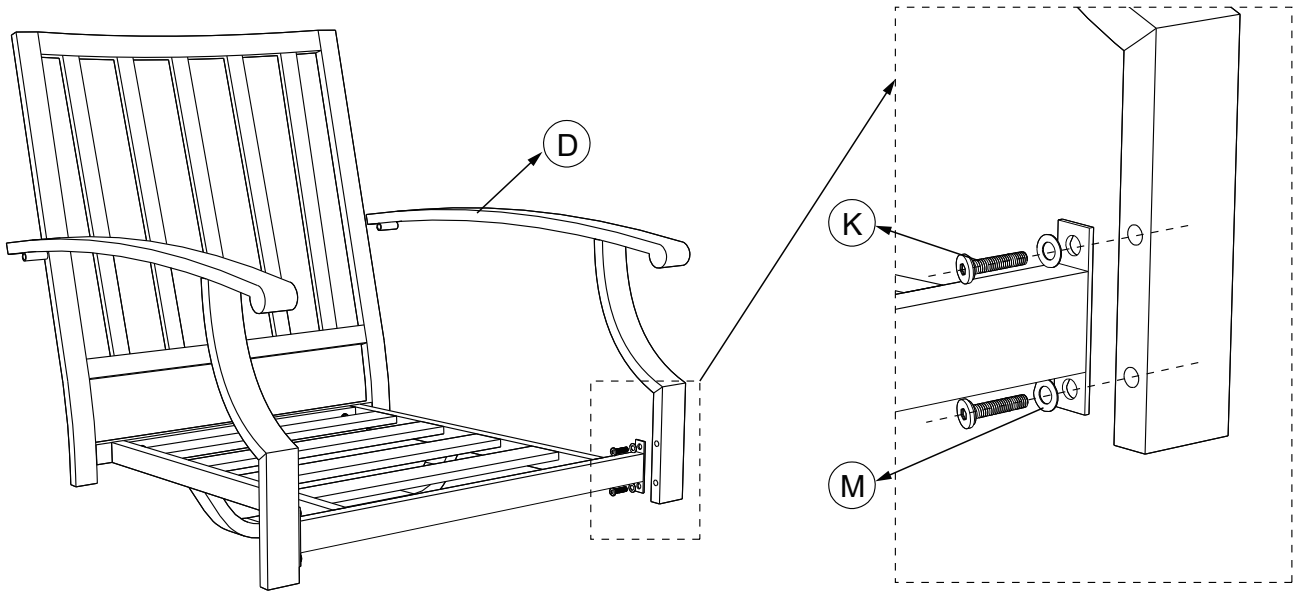

D×2

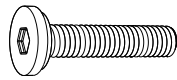

K×4



M×4

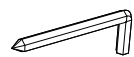

V×1

Step 4

Aligner les trous extérieurs des accoudoirs des deux côtés avec les trous extérieurs de (B) et fixer à l'aide de boulons (L) avec des joints M6 (M).

Remarque : serrer les boulons à ce stade.

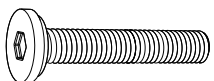
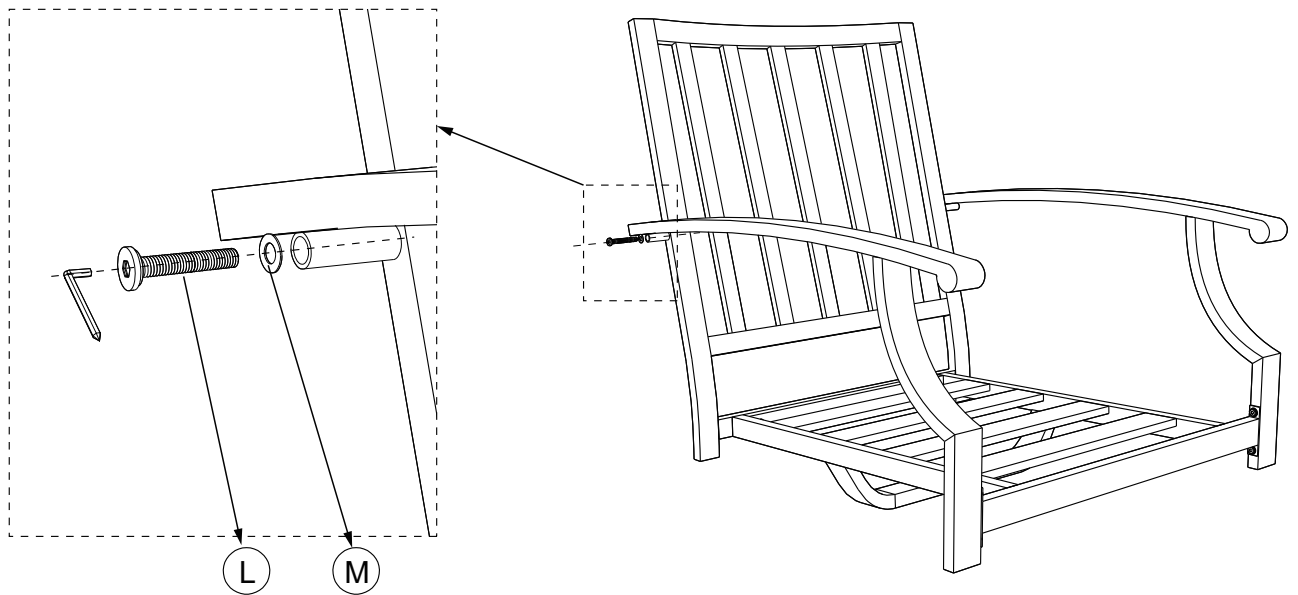

L×4



M×4

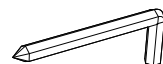



V×1

Step 5

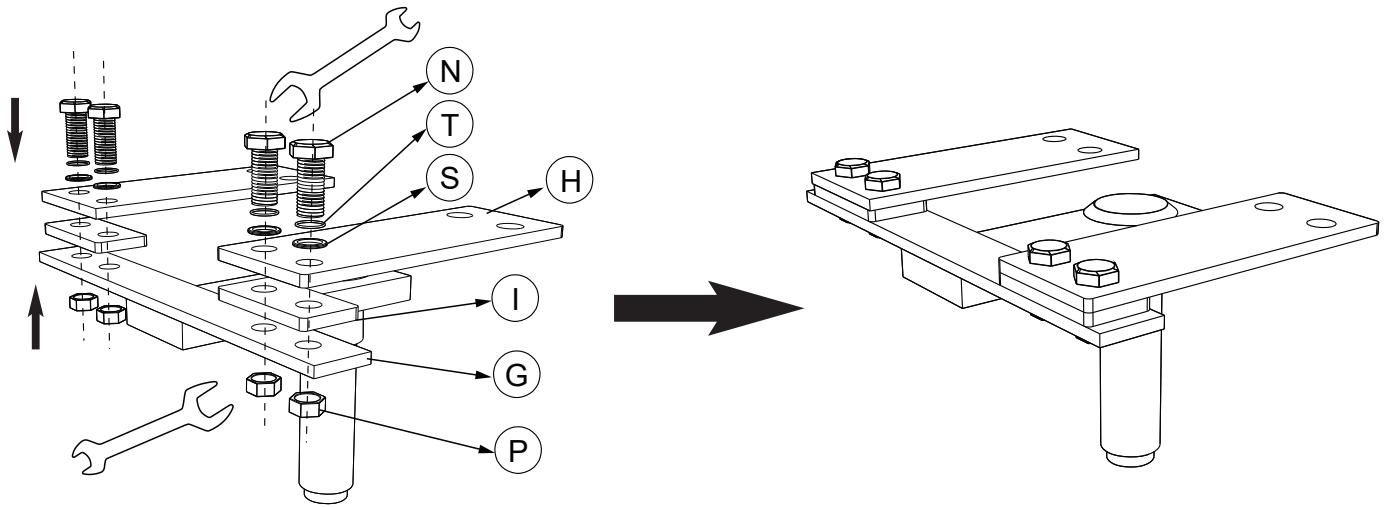
Assemblez les pièces métalliques en forme de T (G), l'acier à ressort (H) et les languettes à ressort (I) dans l'ordre indiqué, et faites passer un boulon (O) à travers l'anneau de retenue (T) et les joints M8 (S) comme indiqué, en le bloquant en place à l'aide du contre-écrou (P) situé en dessous.

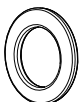
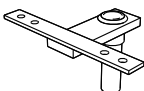
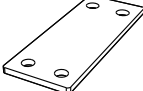
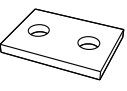



	T×8		S×8
	G×2		H×4
	I×4		O×8
			P×8

Step 6

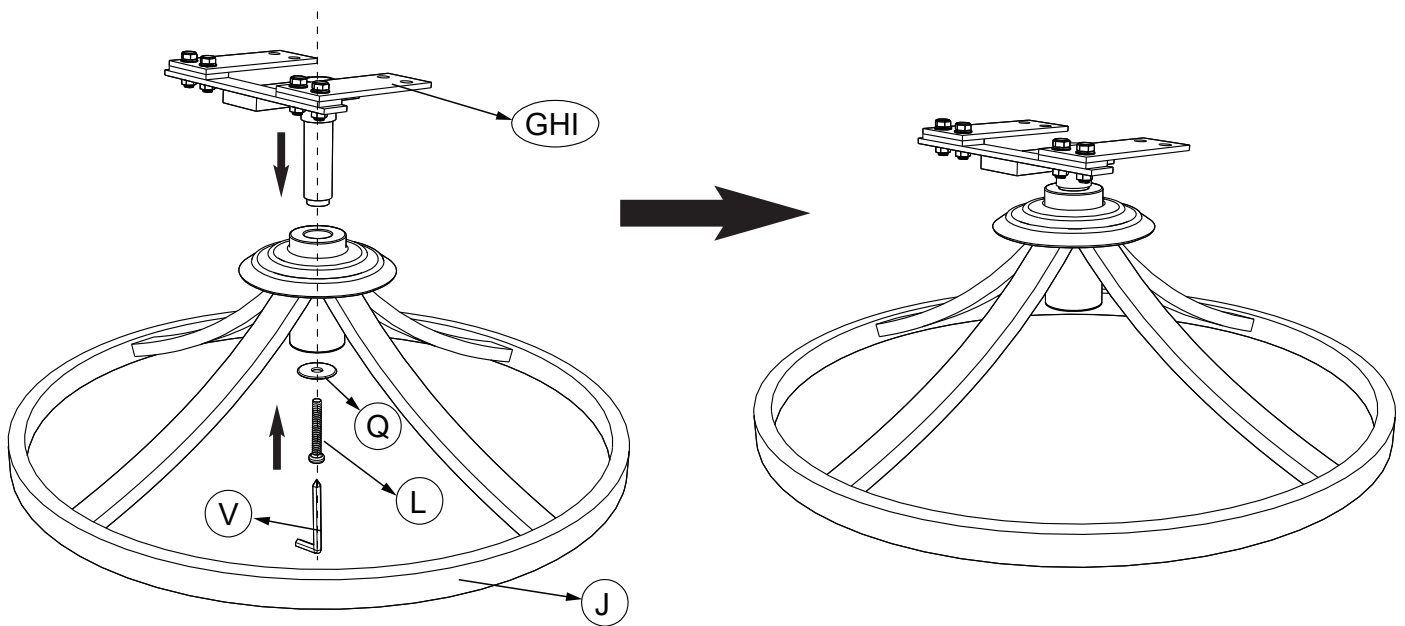
Insérer la partie métallique (GHI) dans le plateau tournant inférieur (J) et serrer le boulon (L) à travers les grands joints M6 (Q) et le verrouiller dans la partie métallique (GHI) comme indiqué.

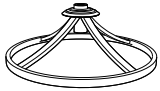
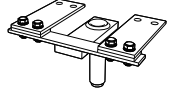
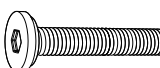

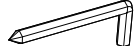
	J×2		GHI×2		L×2		Q×2		V×1
--	-----	---	-------	---	-----	--	-----	---	-----

Step 7

Combinez les parties supérieure et inférieure, alignez les trous inférieurs de (A) avec les trous de (GHI), installez les languettes à ressort (I), le bouchon (N), les joints M8 (S), l'anneau de retenue (T) et le contre-écrou M8 (P) dans l'ordre, et serrez les boulons et les écrous à l'aide de la clé (U).

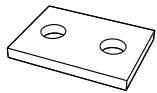
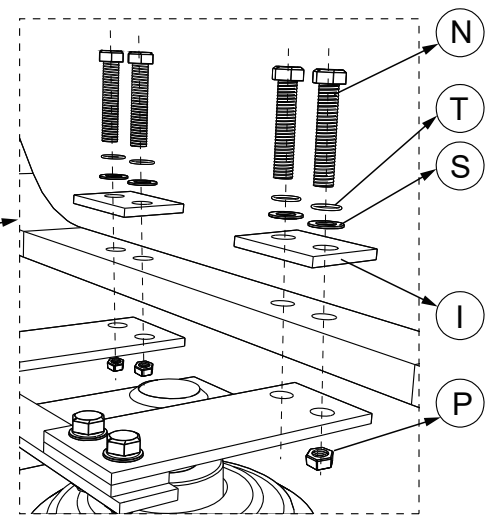
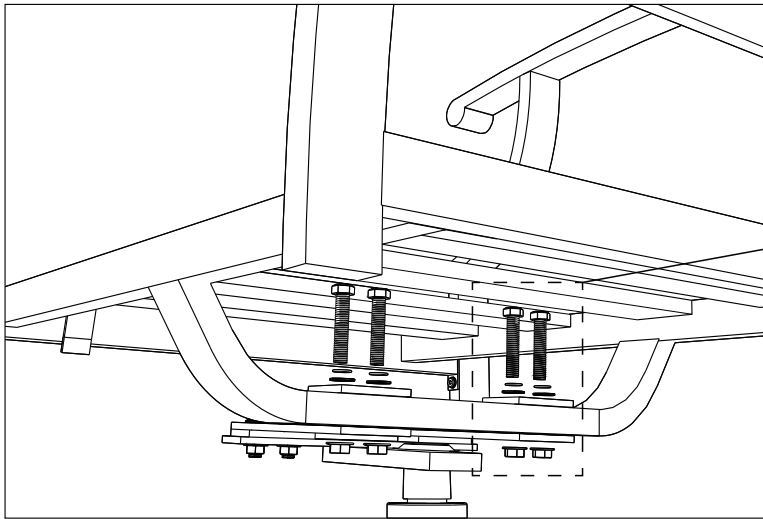

I×2

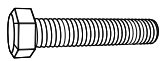

N×8



S×8



T×8



P×8

Step 8

Après avoir placé le coussin (E) sur la plaque d'assise, enrroulez le velcro autour des lattes comme indiqué et serrez.

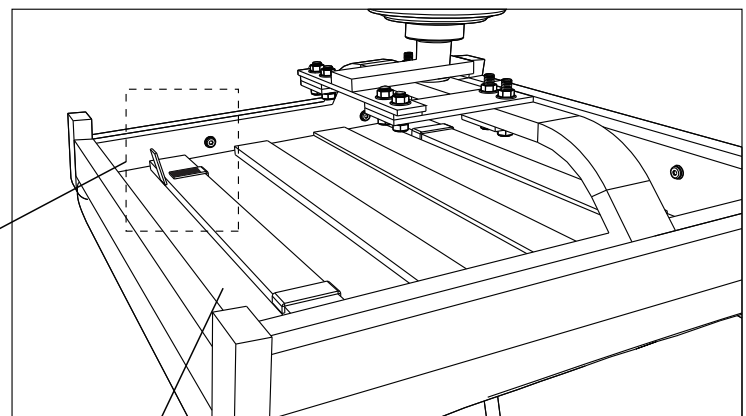
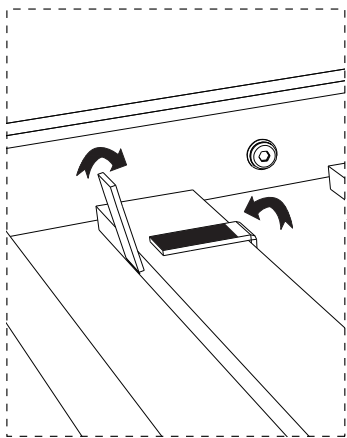
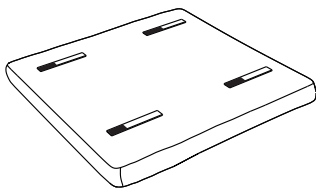

H

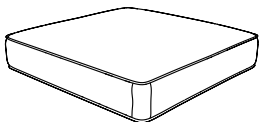

E×2

Step 9

Put all bolt caps(R&W) on the bolts.
Finish by placing the Back Cushion(F) in the chair.

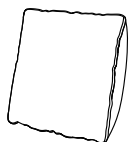

F×2

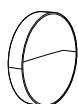

R×2



W×2

OUTDOOR DINING SET: This product can be used in conjunction with our outdoor x-legs longboard table, allowing you to enjoy a high-end outdoor dining experience.

ENSEMBLE DE SALLE À MANGER POUR L'EXTÉRIEUR : Ce produit peut être utilisé en conjonction avec notre table d'extérieur x-legs longboard, ce qui vous permet de profiter d'une expérience de repas d'extérieur haut de gamme.

