









ASSEMBLY INSTRUCTION

BOX OF NIGHTSTAND NIGHTSTAND

ITEM	DRAWING	DESCRIPTION	QTY
A		NIGHTSTAND	1
B		LEG (B) (Located in the bottom drawer)	2
C		LEG (C) (Located in the bottom drawer)	2

BOX OF NIGHTSTAND HARDWARE LIST

ITEM	DRAWING	DESCRIPTION	QTY
1		WOOD DOWEL M8x30mm	4
2		JCBC SCREW M6x40mm	4
3		SPRING WASHER	4
4		FLAT WASHER	4
5		L-KEY M4x65mm	1

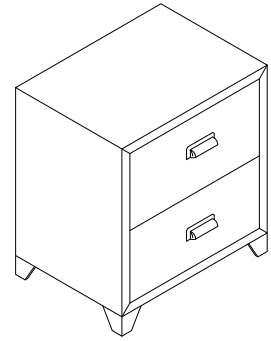

COMPLETED NIGHTSTAND ASSEMBLY

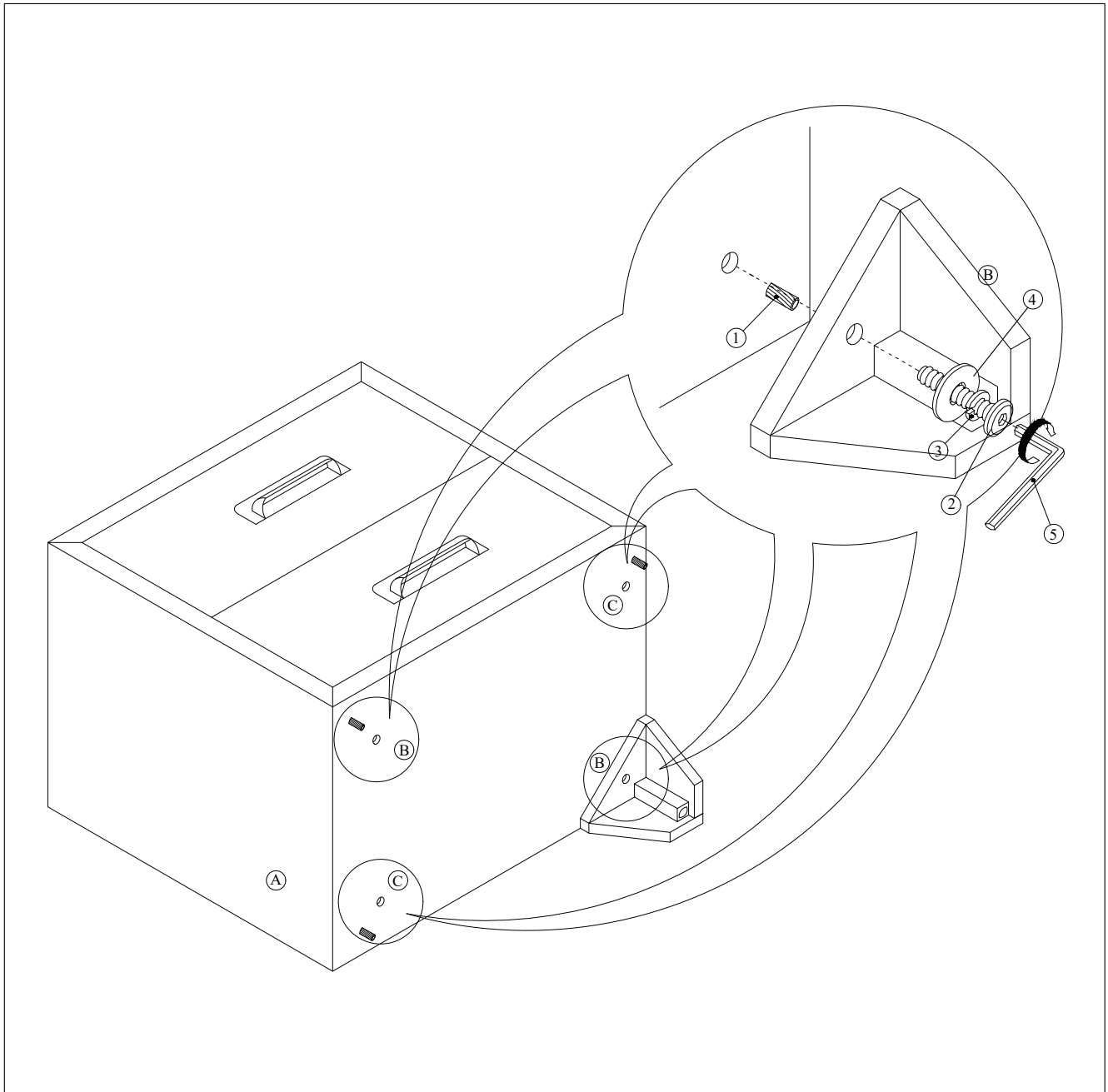

THE HARDWARE IS LOCATED IN THE PACKING ITEMS

NOTE : MUST TIGHT SCREWS PERIODICALL. WITH USE SCREWS MAY BECOME LOOSE.
CHECK TIGHTNESS OF ALL SCREWS EVERY 6-8 WEEKS.

MADE IN MALAYSIA