

KAMA

KAMA

BOOK

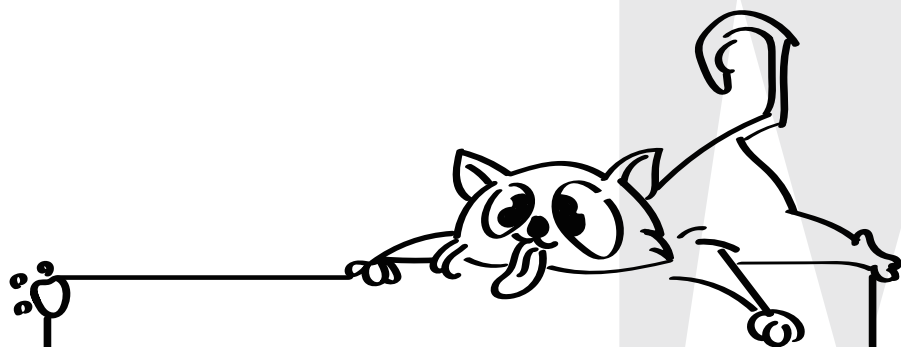

If you're having difficulty, our friendly customer team is always here to help.



WEB:KAMABOKOPETS.com
EMAIL:KMABOKO@163.com

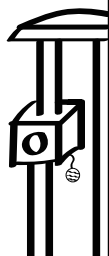

Cat Tree

ITEM-KM060

THIS INSTRUCTION BOOKLET CONTAINS IMPORTANT SAFETY INFORMATION.
PLEASE READ AND KEEP FOR FUTURE REFERENCE.

EN



Before You Start







- ⚠ Please read all instructions carefully.
- ⚠ Retain instructions for future reference.
- ⚠ Separate and count all parts and hardware.
- ⚠ Read through each step carefully and follow the proper order.
- ⚠ We recommend that, where possible, all items are assembled near to the area in which they will be placed in use, to avoid moving the product unnecessarily once assembled.
- ⚠ Always place the product on a flat, steady and stable surface.
- ⚠ Keep all small parts and packaging materials for this product away from babies and children as they potentially pose a serious choking hazard.



EN









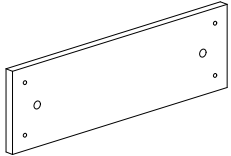
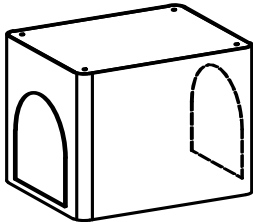

Return / Damage Claim Instructions

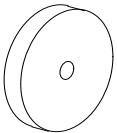
- ⚠ **DO NOT discard the box / original packaging.**
In case a return is required, the item must be returned in original box. Without this your return will not be accepted.
- ⚠ **Take a photo of the box markings.**
A photo of the markings (text) on the side of the box is required in case a part is needed for replacement. This helps our staff identify your product number to ensure you receive the correct parts.
- ⚠ **Take a photo of the damaged part (if applicable).**
A photo of the damage is always required to file a claim and get your replacement or refund processed quickly. Please make sure you have the box even if it is damaged.
- ⚠ **Send us an email with the images requested.**
Email us directly from marketplace where your item was purchased with the attached images and a description of your claim.

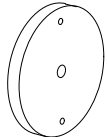
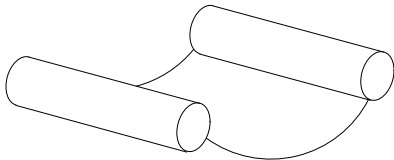

| Accessory | Size | Quantity |
|---|----------|----------|
| A  | 5mm*60mm | 17PCS |
| B  | 8mm*40mm | 17PCS |
| C  | ----- | 4PCS |
| D  | 6mm*16mm | 8PCS |
| E  | 6mm*35mm | 8PCS |
|  | 5mm | 1PC |

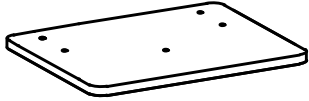
| Plasterboard wall screw installation | | |
|---|------------|-------|
| A  | 4.5mm*80mm | 17pcs |
| B  | 10mm*36mm | 17pcs |

| | | |
|--|---|---|
| <p>1</p> <p>440mm*135mm*15mm</p>  <p>1PC</p> | <p>5</p>  <p>1PC</p> | <p>9</p>  <p>1PC</p> |
| <p>2</p> <p>90mm*90mm*15mm</p>  <p>2PCS</p> | <p>6</p> <p>270mm</p>  <p>4PCS</p> | <p>10</p> <p>135mm*135mm*15mm</p>  <p>1PC</p> |
| <p>3</p>  <p>1PC</p> | <p>7</p> <p>390mm*180mm*15mm</p>  <p>1PC</p> | <p>11</p> <p>300mm</p>  <p>1PC</p> |
| <p>4</p> <p>300mm</p>  <p>2PCS</p> | <p>8</p> <p>440mm*340mm*15mm</p>  <p>1PC</p> | |

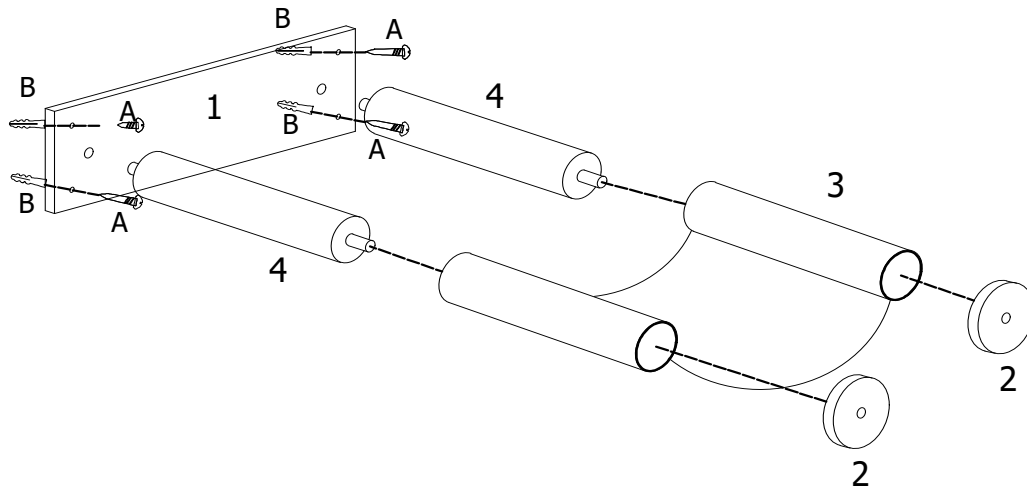



1

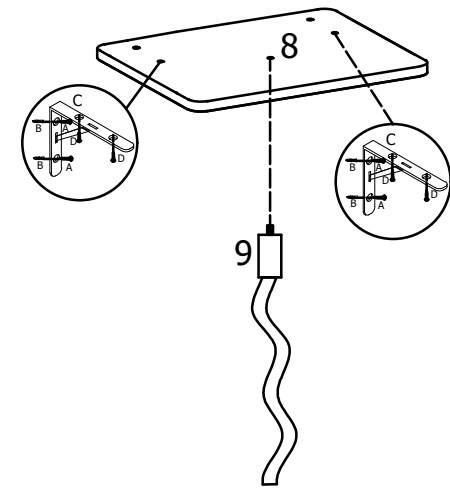

| | | |
|----------|---|----|
| A |  | x4 |
| B |  | x4 |

2



| | | |
|----------|---|----|
| A |  | x4 |
| B |  | x4 |
| C |  | x2 |
| D |  | x4 |

3

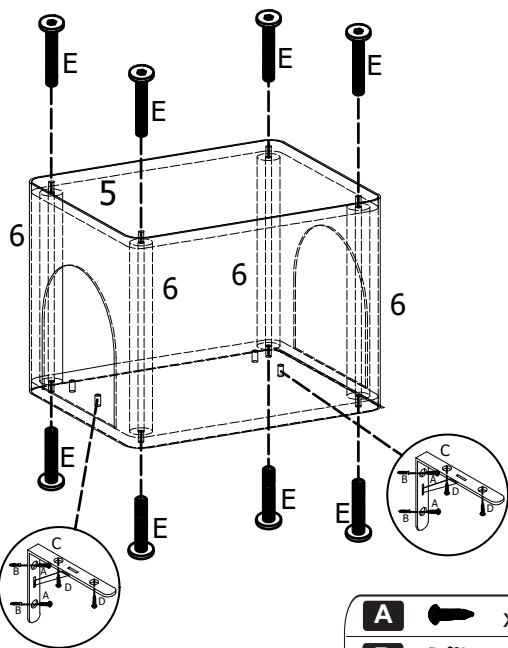

| | | |
|----------|--|----|
| A | | x4 |
| B | | x4 |
| C | | x2 |
| D | | x4 |
| E | | x8 |

4

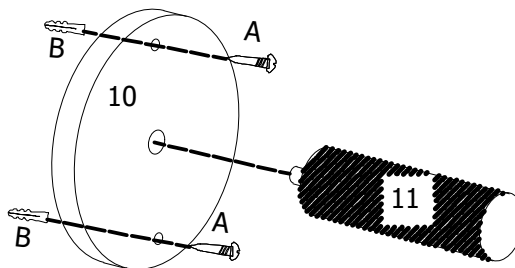

| | | |
|----------|--|----|
| A | | x2 |
| B | | x2 |

5

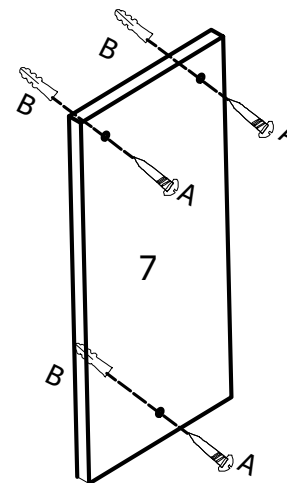

| | | |
|----------|--|----|
| A | | x3 |
| B | | x3 |