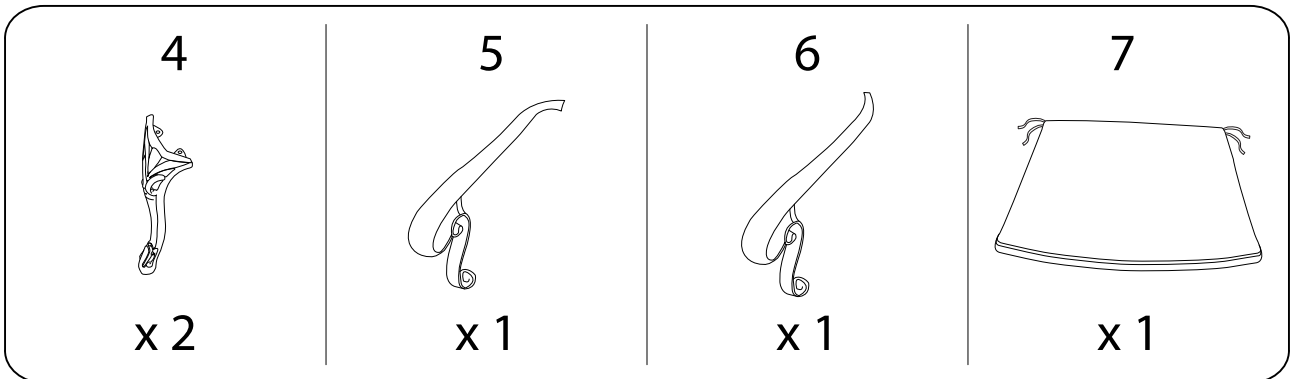
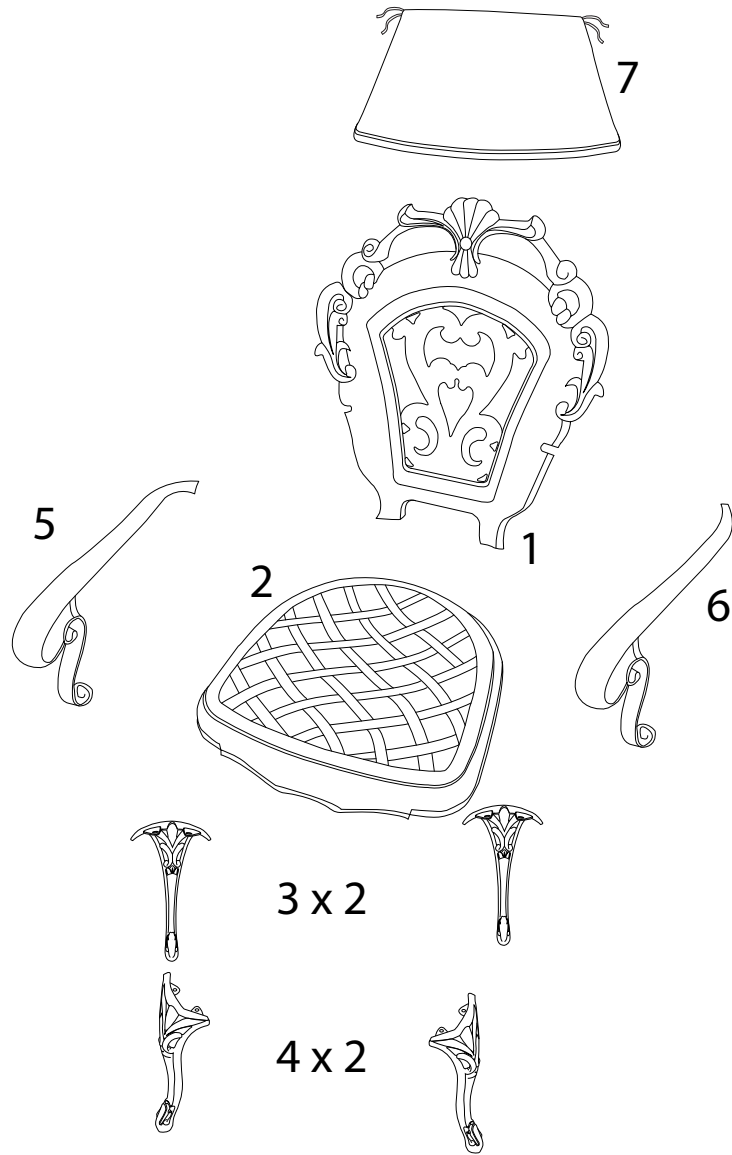
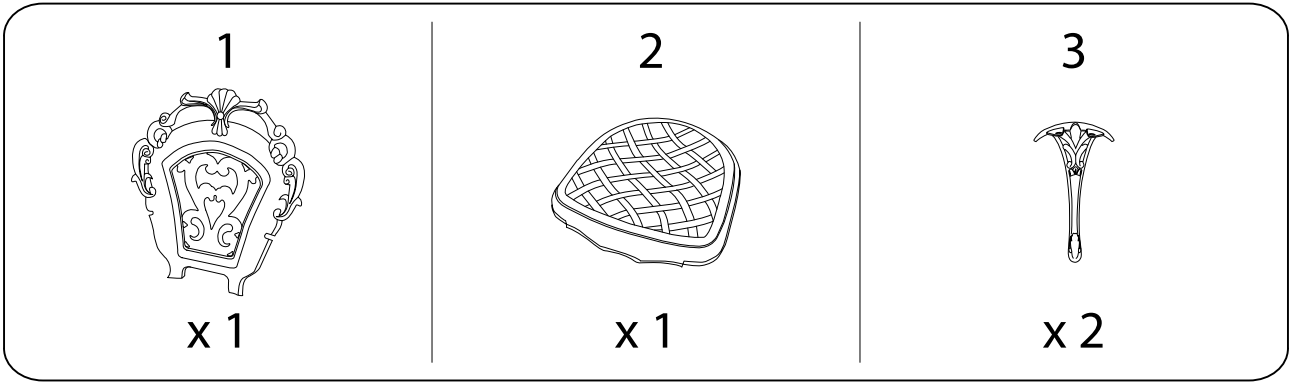
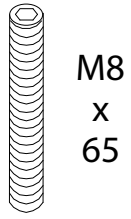

Diagram illustrating assembly instructions and safety warnings:

- Warning 1:** A triangle with an exclamation mark points to a box containing an L-shaped metal bracket and a power drill with a slash through it, indicating that a power drill should not be used for this step.
- Warning 2:** A triangle with an exclamation mark points to a box containing a rectangular block being placed on a surface and a diagram showing a block being secured with a screw.
- Time:** A clock icon indicates a duration of **30'** (30 minutes).
- Person:** An icon of a person indicates that **1** person is required for this step.



A



x 2

B

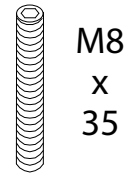

x 8

C

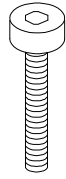

x 2

D

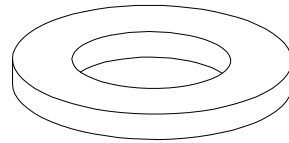

x 10

E

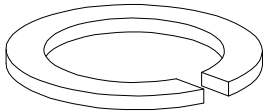

x 10

F

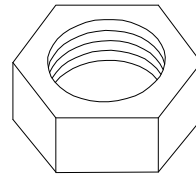

x 10

G

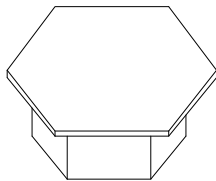

x 10

H

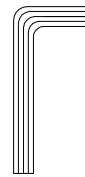

x 1

I

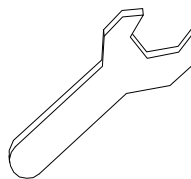

x 1

1

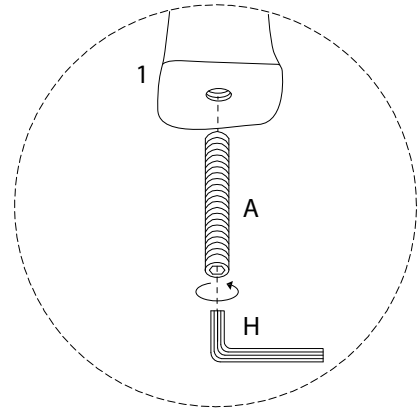
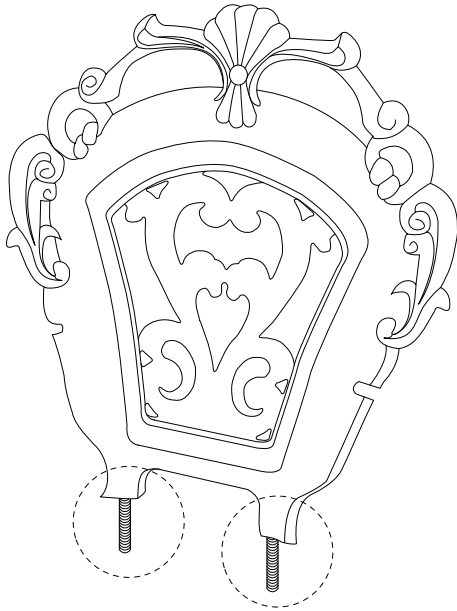
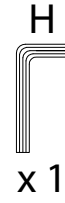
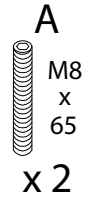

2

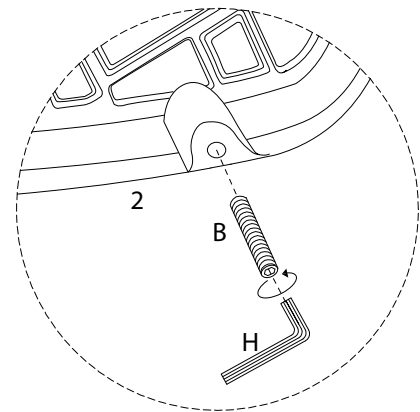
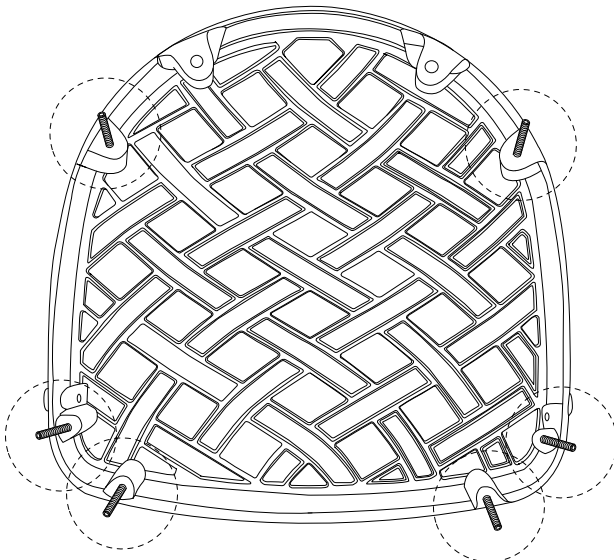
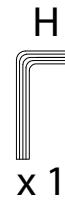
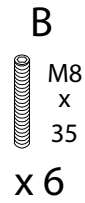
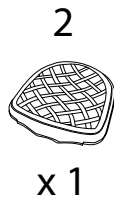

3

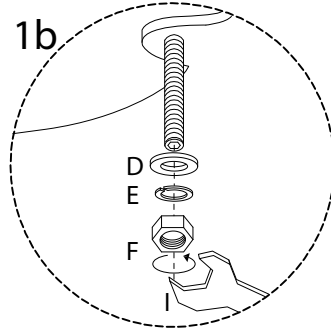
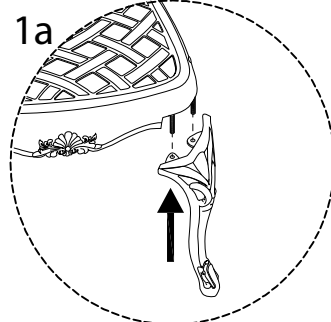
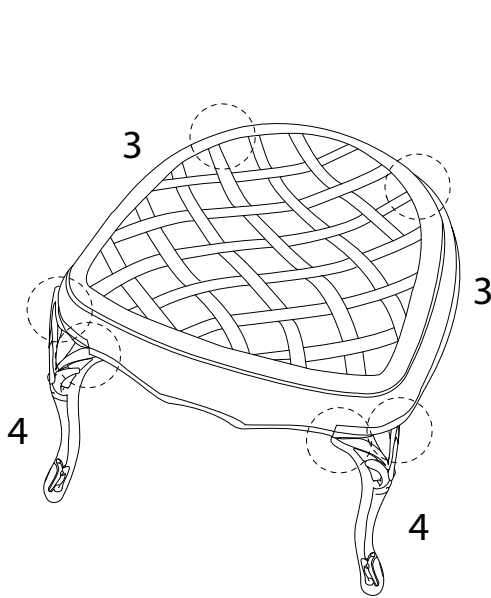
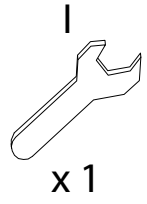
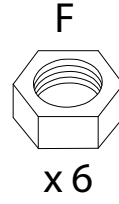
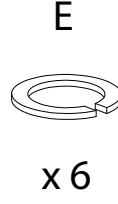
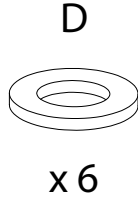

4

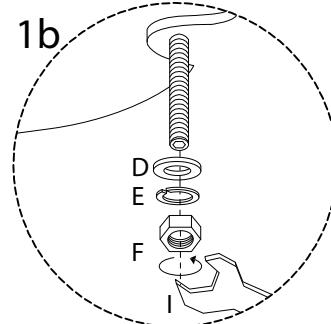
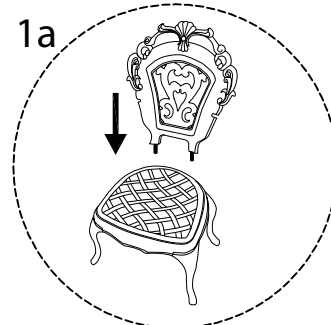
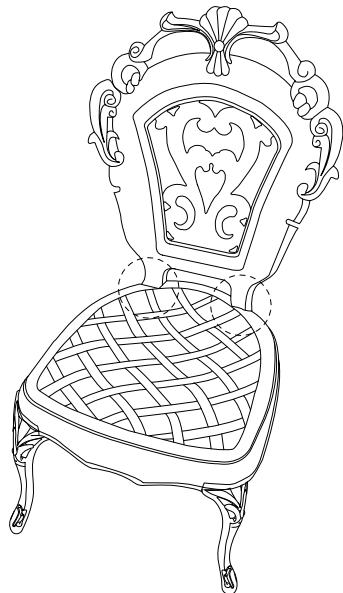
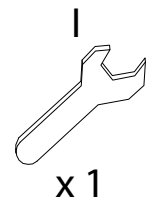
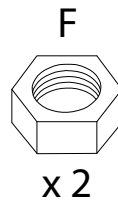
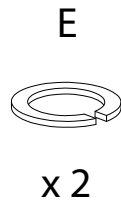
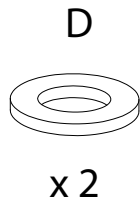

5

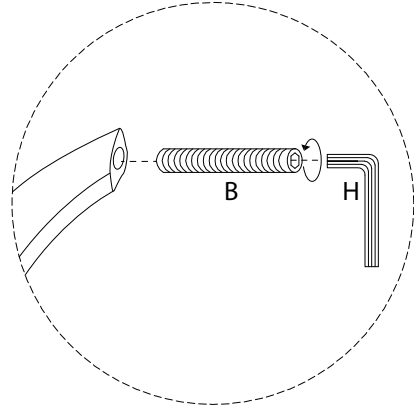
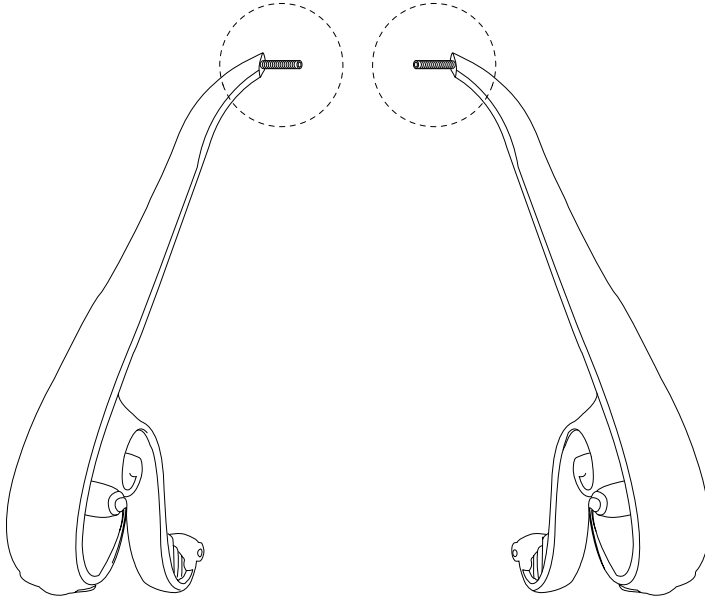
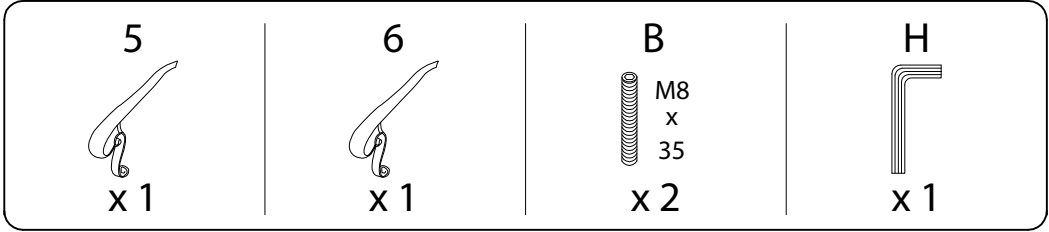

6

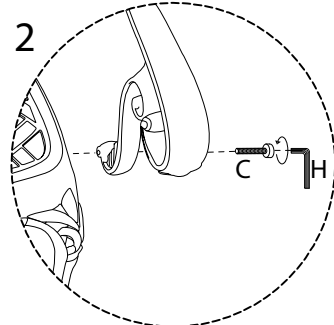
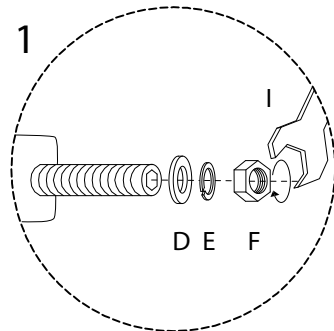
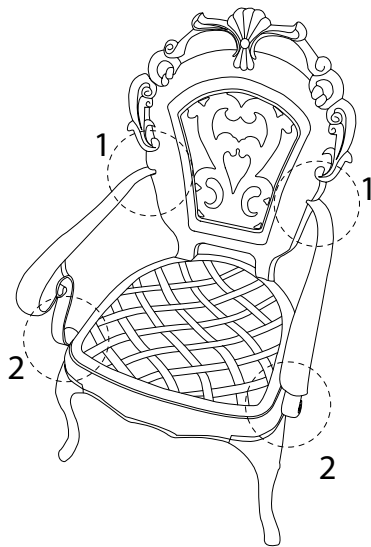
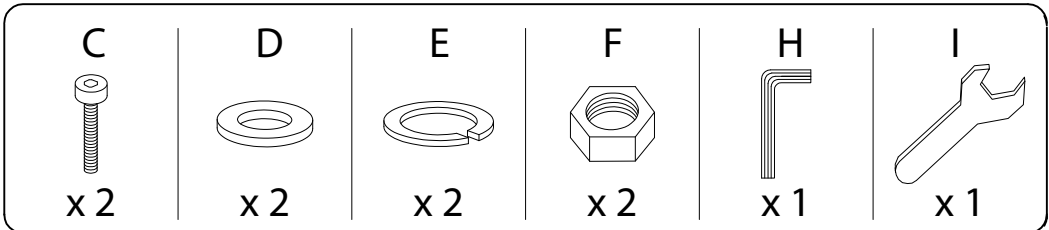

7

G

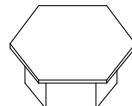

x 10

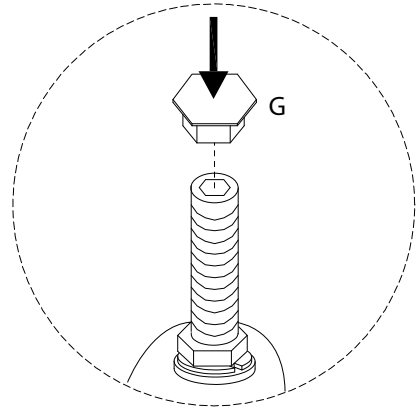
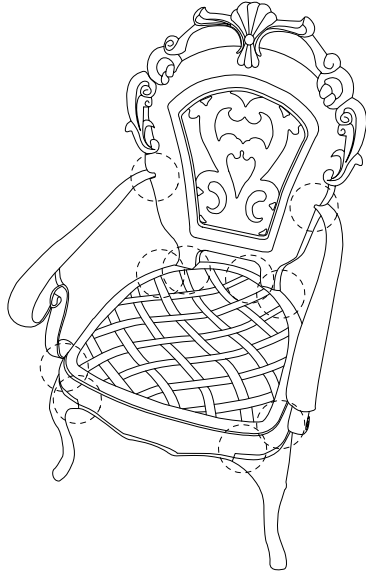

8

7

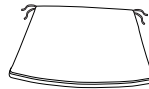

x 1

