







A		1pc	Body
B		1pc	Wedge back
C		1pc	Back cushion
D		1pc	Seat cushion
E		1pc	Transformer
F		1pc	Charger

1 Pull the power input wire from the back of the body, connect with the transformer and charger.



2 Find switch panel on the side of the seat cushion .

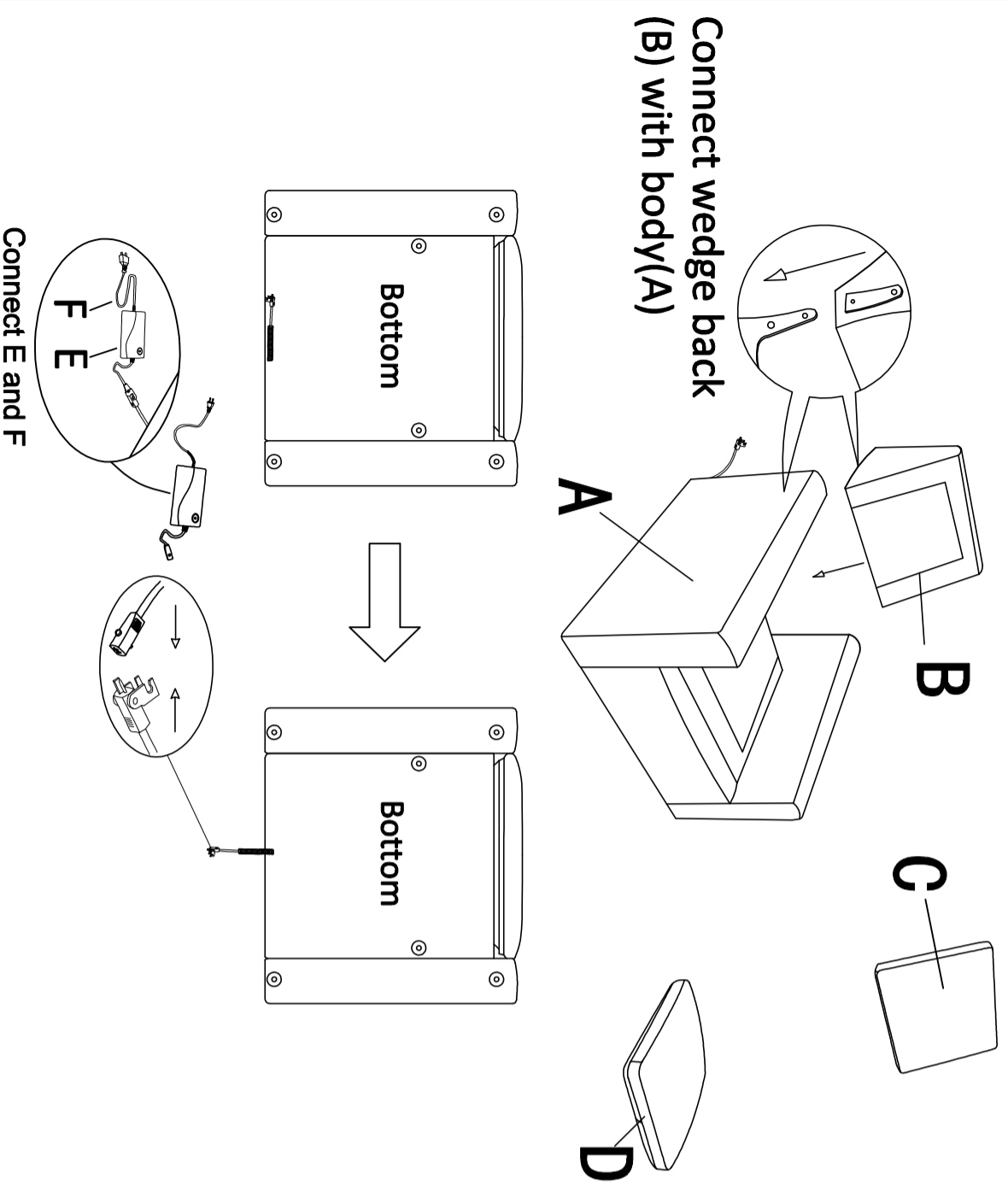
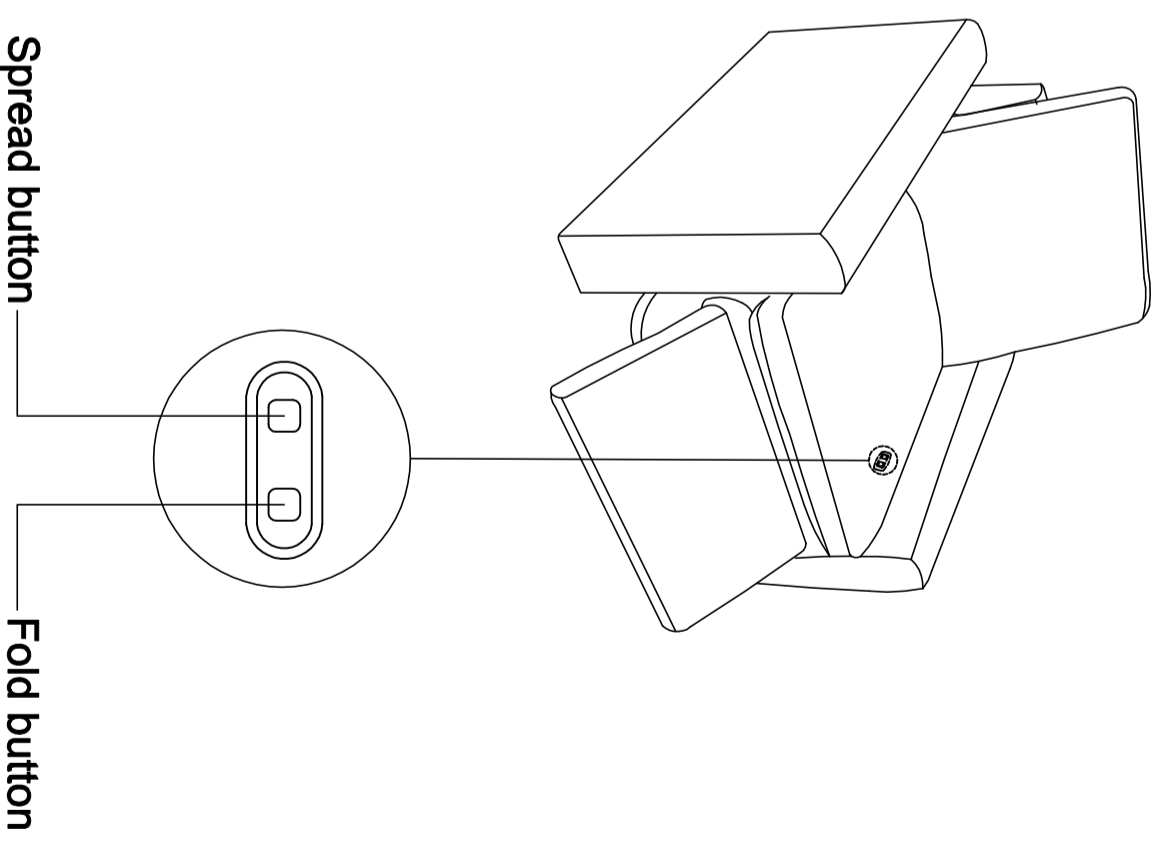

Product description: Power Recliner AI