

Assembly instructions

Caution: You must read this before you proceed.

Table

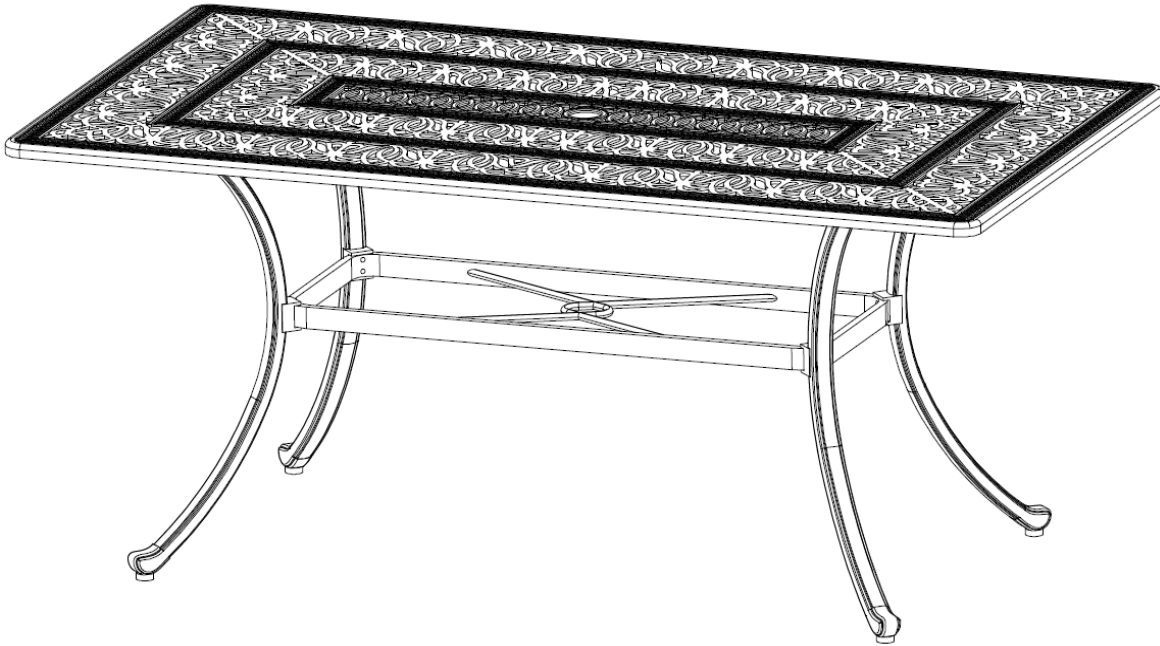









**CAUTION: This table is NOT a TOY.
Keep your child / children at bay in the process of assembly.**

Parts list

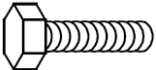
NO.	Picture	Description	QTY
A		Table Top	1
B		Legs Support	1
C		Leg with pre-attached Leveller	4

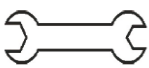
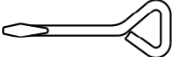
Hardware

Label	Picture	Description	QTY
①		Stud(M8*32mm)	9
②		Washer(M8mm)	9
③		Spring Washer(M8mm)	9
④		Nut(M8mm)	9
⑤		Bolt(M6*27mm)	9
⑥		Spring Washer(M6mm)	9
⑦		Washer(M6mm)	9
⑧		Spanner	1
⑨		Screwdriver	1
⑩		Nut cap(M6)	9

Assembly Preparation

Before Beginning Assembly:

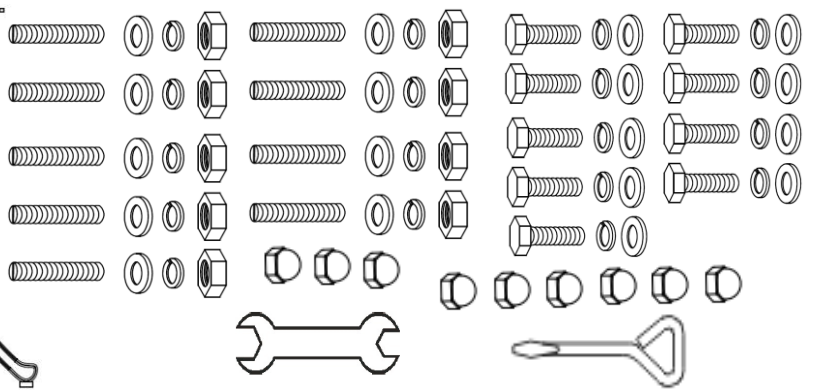
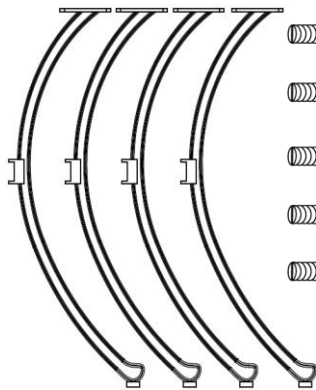
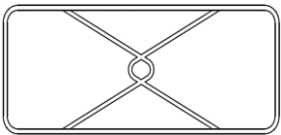
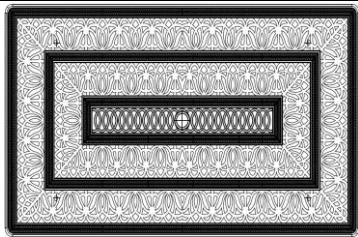

- Read instructions, cover to cover-



- Have 2 adults on hand for assembly-



- Do not assemble on flooring or carpet-



- Assemble on a clean non-marring surface (packing foam)-



- Save all packaging until finished-

Assembly Step

Overview

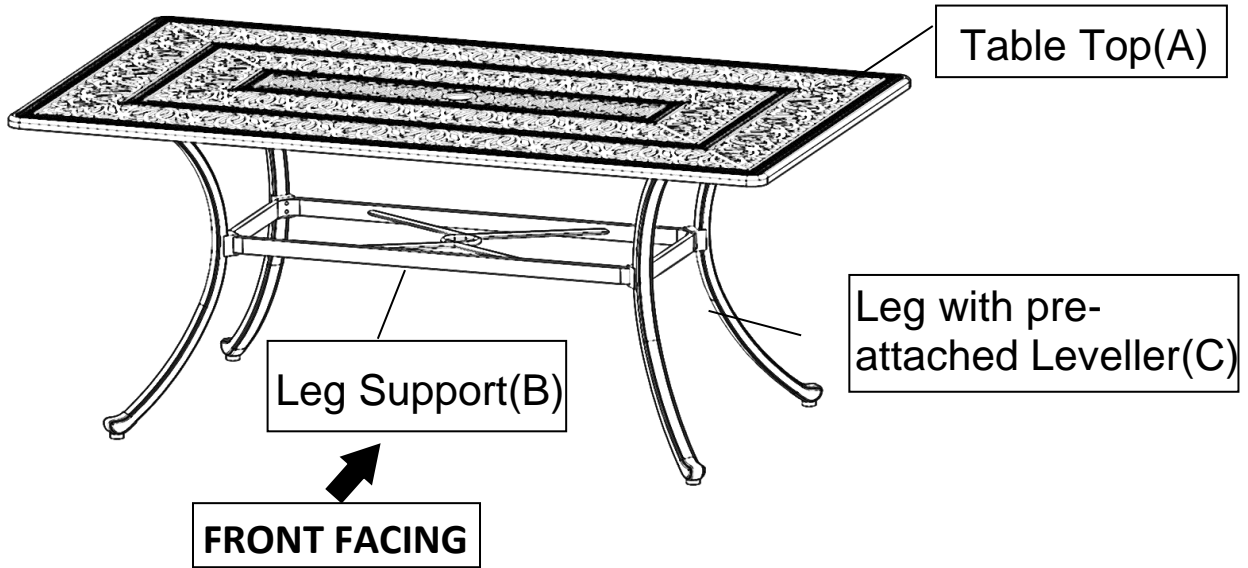

This table has multiple parts and may require up to some 30 minutes to assemble. To give you an overview of the table parts, the above picture is to help you put the various parts into perspective.

Please read through the instructions below to familiarise yourself with the parts and steps before assembly.

Step 1

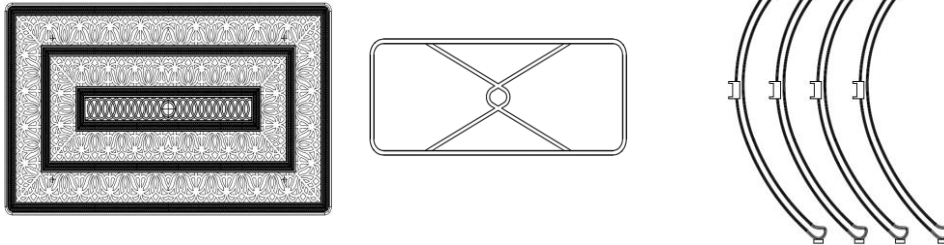

Unpack and place all parts onto a clean soft surface.

Step 2

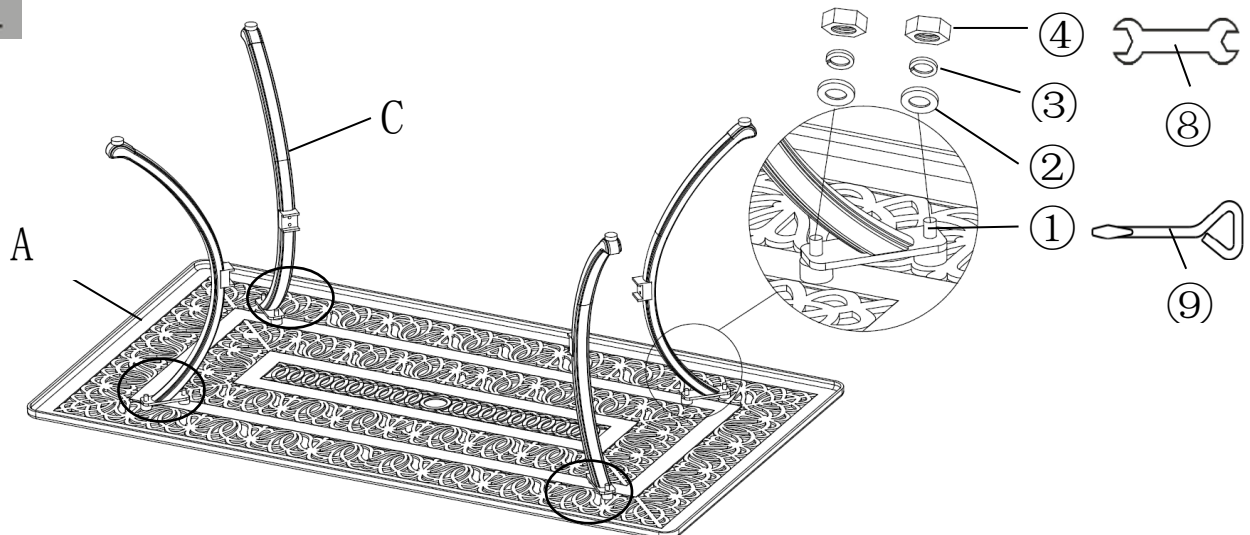

Place the Table Top(A) underside facing skywards.

Fix the Stud(①) into the table top(A) with the Screwdriver(⑨).

Then place and fit the Four Table Legs(C) over the bolts fitting on the Table Top(A) using Washer(②), Spring Washer(③) and Nut(④) with the Spanner(⑧).

DO NOT over tighten, yet.

Step 3

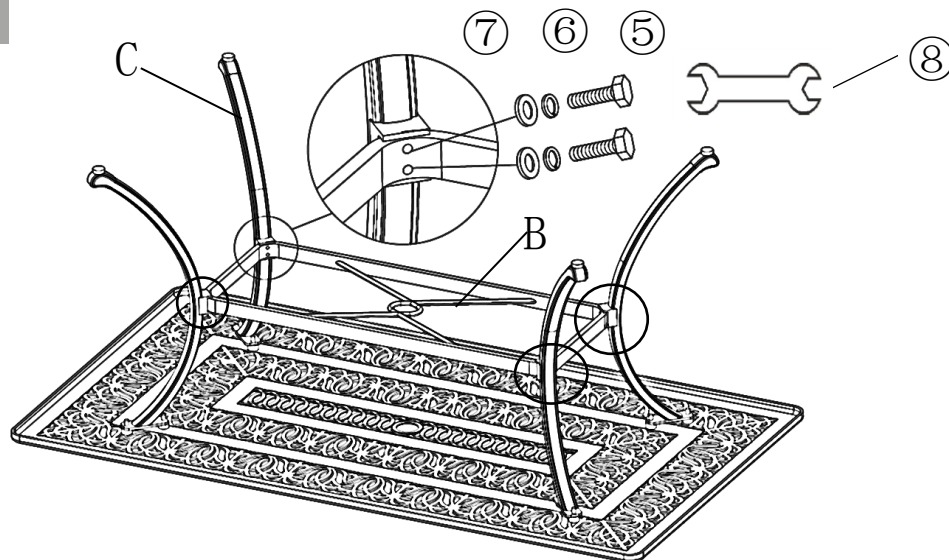

Loosely attach the Legs support(B) to Leg with pre-attached Leveller(C) with Bolt(⑤), Spring Washer(⑥) and Washer(⑦) using Spanner(⑧).

Repeat the same process for all contact points of the Table Legs and Legs Support.

DO NOT OVERTIGHTEN.

Step 4

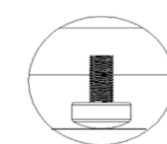
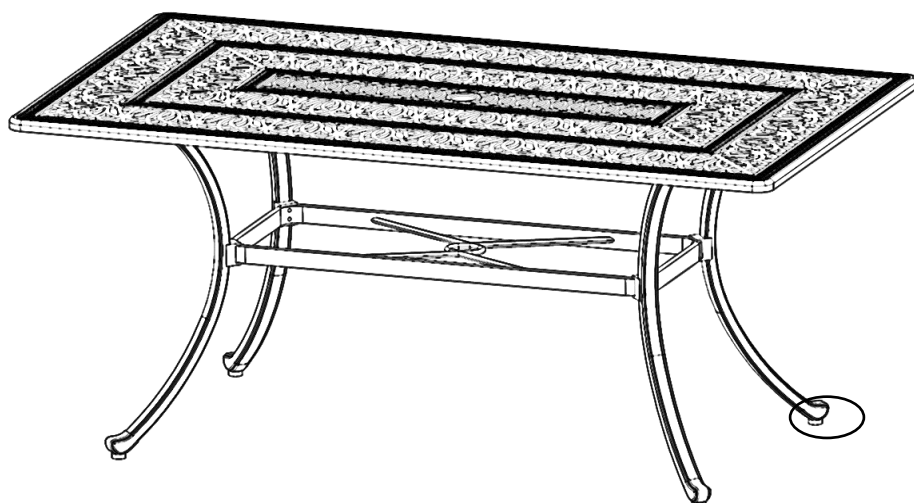

Adjust height
for balance

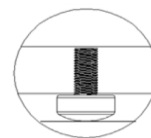

Adjust low
for balance

Adjust Pre-installed
Levellers
height for balance

Stand the table right side up.



















Now, fully and securely, tighten all nuts, at all joints.

Add Nut Cap(⑩) on eight bolt ends on Leg Support to protect skin or clothing from getting snagged.

Adjust the Legs pre-installed Levellers until the Table is level with the ground.

Caution: This TABLE can only be used on a flat, level surface.

Care & Maintenance

-   Do not put hot items directly on furniture surface
 -   Do not clean furniture with harsh cleansers or polish.
 -   To obtain the longest lifespan of your outdoor products, minimizing exposure to direct sunlight is recommended.
 -   Children should not climb or jump on the furniture.
 -   Do not write on furniture without a padded barrier to protect the surface.
 -   To obtain the longest lifespan of your outdoor products, avoid extended and lengthy exposure to rain, snow, and direct sunshine. Whenever possible cover the product and /or place under patio or awnings.
 -   Not for commercial use. For residential use only .
 -   Stains may be removed with mild soap solution and damp cloth.
-
-   Dust and pick-up spills using a clean, non-colored, lint-free cloth .

Questions & Answers about Proposition 65

• What is Proposition 65?

Proposition 65 requires businesses to provide warnings to Californians about significant exposures to chemicals that cause cancer, birth defects or other reproductive harm. These chemicals can be the products that Californians purchase, in their homes or workplaces, or that are released into the environment. By requiring that this information be provided, Proposition 65 enables Californians to make informed decisions about their exposures to these chemicals.

Proposition 65 also prohibits California businesses from knowingly discharging significant amounts of listed chemicals into sources of drinking water.

Proposition 65 requires California to publish a list of chemicals known to cause cancer, birth defects or other reproductive harm. This list, which must be updated at least once a year, has grown to include approximately 900 chemicals since it was first published in 1987.

• What types of chemicals are on the Proposition 65 list?

The list contains a wide range of naturally occurring and synthetic chemicals that include additives or ingredients in pesticides, common household products, food, drugs, dyes, or solvents. Listed chemicals may also be used in manufacturing and construction, or they may be byproducts of chemical processes, such as motor vehicle exhaust.

• What does a warning mean?

If a warning is placed on a product label or posted or distributed at a workplace, a business, or in rental housing, the business issuing the warning is aware or believes that it is exposing individuals to one or more listed chemicals.

By law, a warning must be given for listed chemicals unless the exposure is low enough to pose no significant risk of cancer or is significantly below levels observed to cause birth defects or other reproductive harm.

• Where can I get more information on Proposition 65?

If you have specific questions on the administration or implementation of Proposition 65, you can contact OEHA's Proposition 65 program at P65.Questions@oehha.ca.gov, or by phone at (916)445-6900.