

## Instruction Manual

First of all ,we would like to sincerely thank our customers for trusting and using our products.Our products always meet customer satisfaction. If during use or if you have any problems that need support regarding the product, do not hesitate to contact us via email for timely support from our dedicated and professional customer care team.





## 1. ASSEMBLY PREPARATION AND TIPS FOR ASSEMBLY

- 1). Remove all packaging materials, staples and packing straps from the carton.
- 2). Refer to Parts List and Hardware List, and ensure parts and hardware are correct before assembly.  
Contact customer service for missing parts.
- 3). Place all wooden parts on a clean, flat and soft surface (e. g. carpet or rug) to prevent scratch and damage to parts.
- 4). Allow ample room for assembly and assemble the product near where the product will be placed.
- 5). During assembly, do not over-tighten any fittings as this may cause damage.
- 6). Always place the product on a flat, level surface.

## 2. RE AND MAINTENANCE

- 1). KEEP ALL HARDWARE PARTS OUT OF REACH OF CHILDREN.
- 2). Wipe clean with a soft, dry cloth; avoid the use of harsh chemicals or household cleaners as they may damage the exterior finish of the furniture.
- 3). Hardware may loosen over time. Periodically, check that all connections are tight; re-tighten as necessary.

## 3. PS TO PROTECT & CARE FOR YOUR FURNITURE

- 1). Avoid placing your furniture in direct sunlight, as sunlight causes fading.
- 2). Use a protective pad when writing on the furniture surface.
- 3). Use cutting boards and trivets for food preparation in order to avoid damaging the top for the unit

# Exploded View

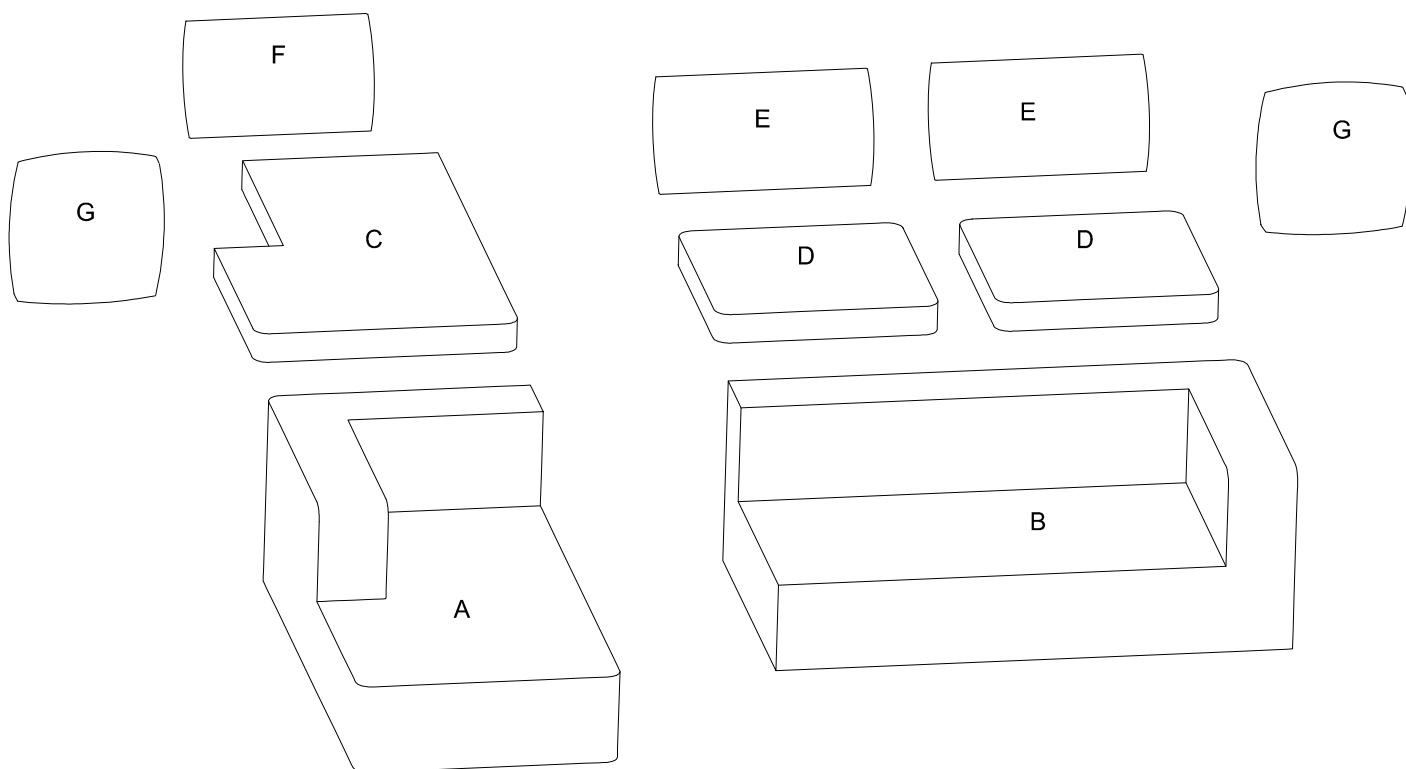

# The package includes

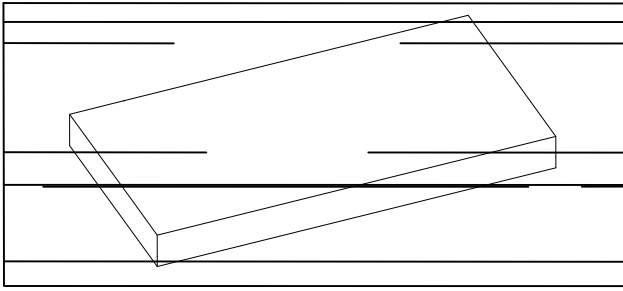

← Package 1

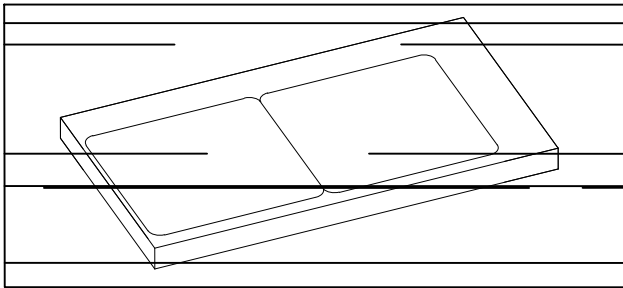

← Package 2

# Parts List

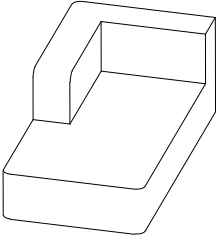
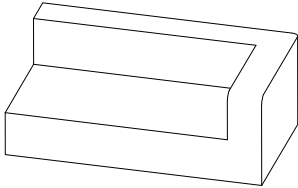
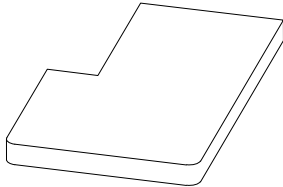
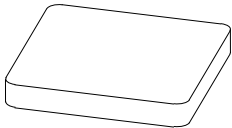
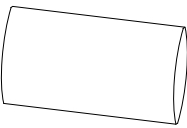
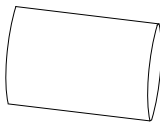
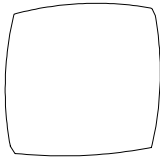

<p><b>A</b></p>  <p>Empress chair 1pcs</p>	<p><b>B</b></p>  <p>Double chair 1pcs</p>	<p><b>C</b></p>  <p>Imperial mattress 1pcs</p>	<p><b>D</b></p>  <p>Single mattress 2pcs</p>
<p><b>E</b></p>  <p>Cushion mattress 2pcs</p>	<p><b>F</b></p>  <p>Cushion mattress 1pcs</p>	<p><b>G</b></p>  <p>Cushion 2pcs</p>	

Step 1: Cut the bag open and pat around to return it to its original state.

### Package 1

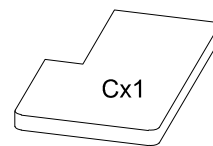
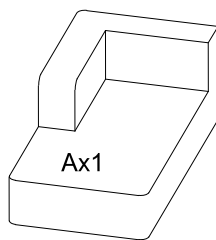
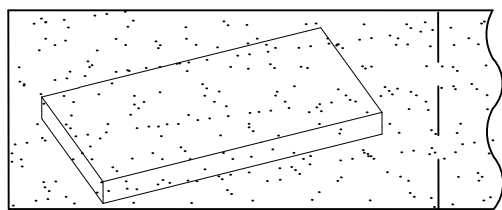

Cutting place

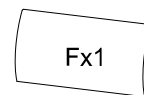

### Package 2

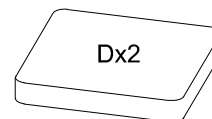
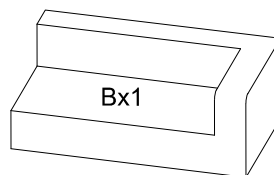
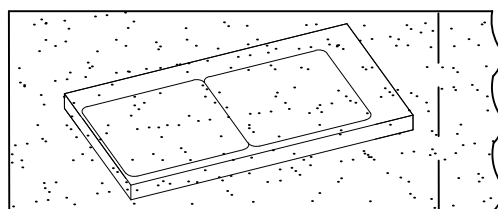

Cutting place

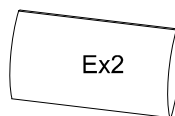

Step 2: Connect the two chairs together with tape.

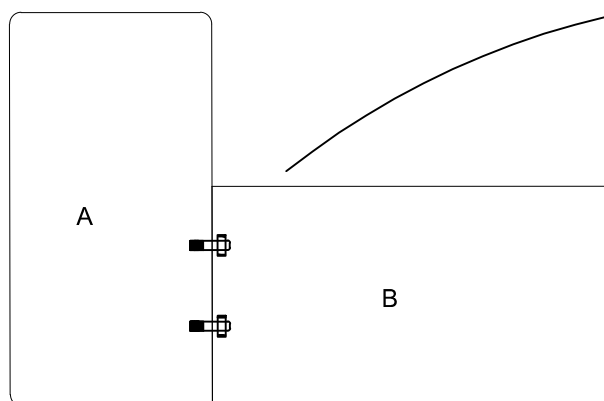
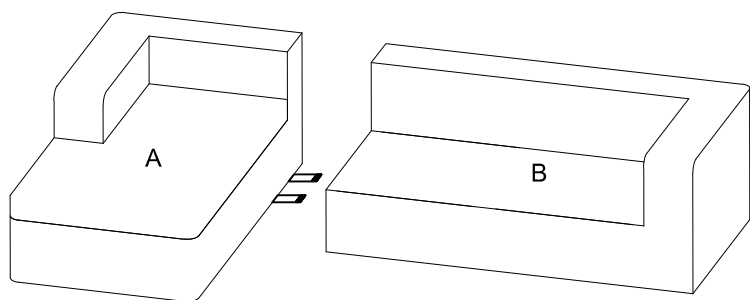

Insert the wire from the bottom and stick it with tape.

Step 3: Place the cushions on the royal throne.

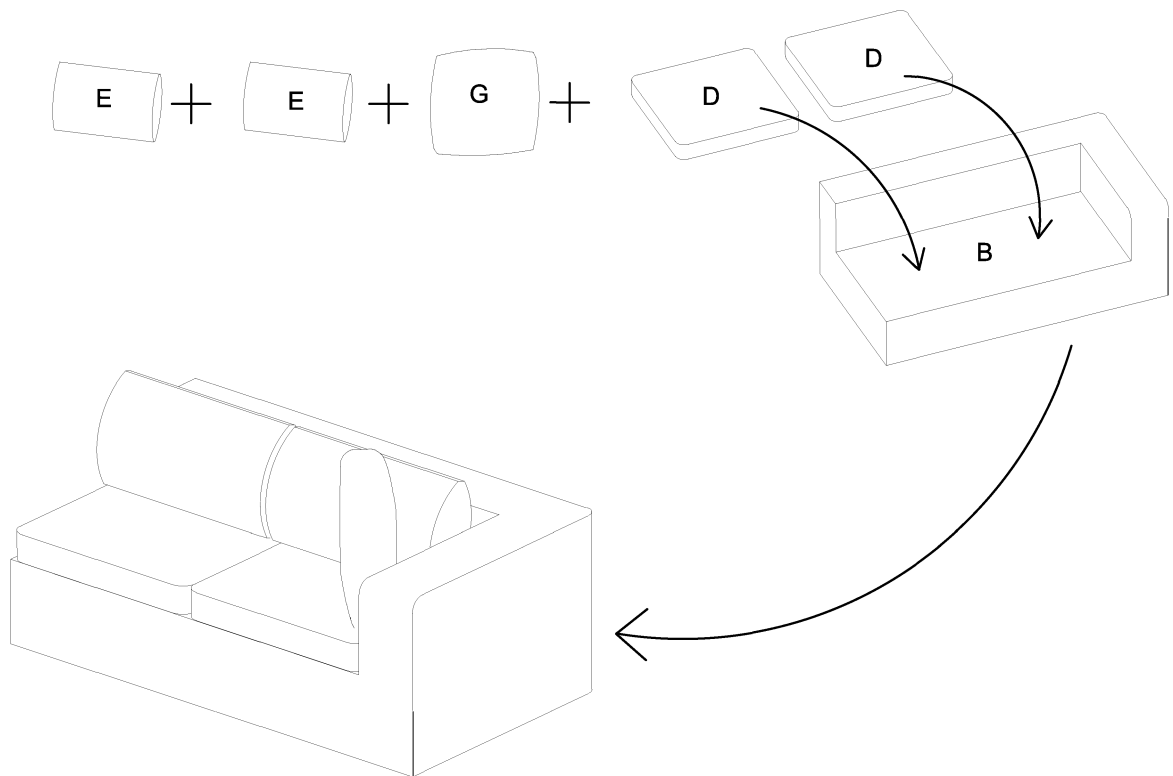
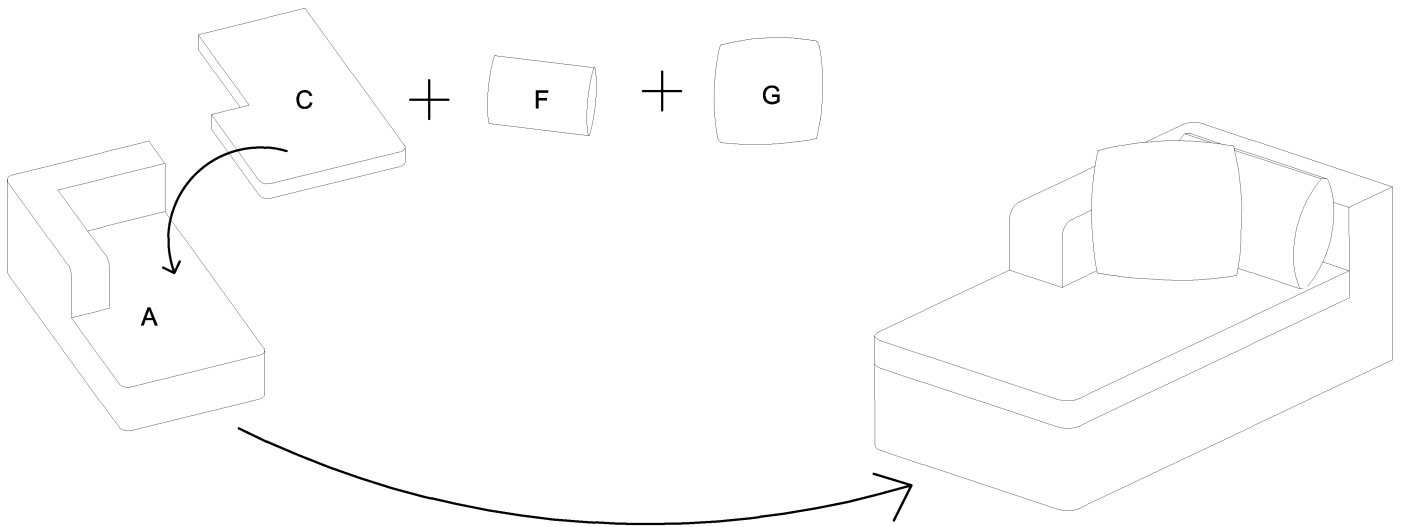

## Step 4: Completed the installation process

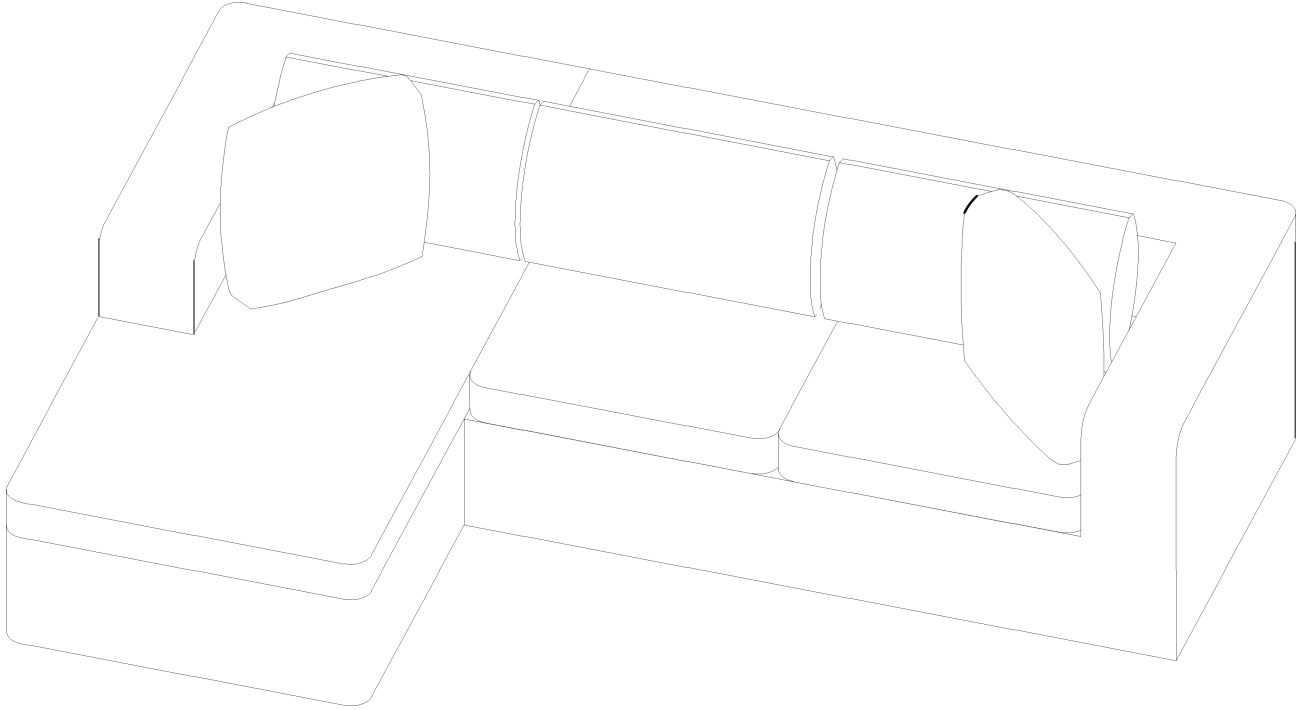

**Warning:** Seller is responsible for the product-related issues occurred upon receipt, but will not be responsible for the personal injury, property damage or loss resulting from the incorrect assembly, improper use, inadequate maintenance or neglect of this product.

