

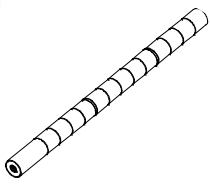





# PARTS LIST

Your Stainless Steel Top Kitchen Cart should include the following parts. Please inspect box contents to ensure you have received all components.

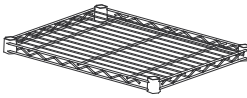
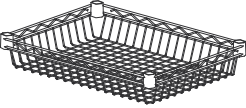
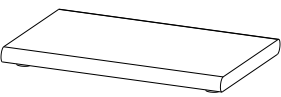
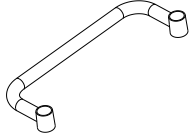
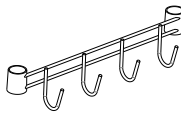
If you are missing any parts, need assistance with assembly or have questions, please contact Customer Service.

- |  |   |  |   |
|--|---|--|---|
| <p><b>A</b></p>  <p><b>BOTTOM POLE (4)</b><br/>Threaded Insert (4)<br/>is pre-installed</p> | <p><b>B</b></p>  <p><b>TOP POLE (4)</b><br/>End Cap (4) and<br/>Pole Connector (4)<br/>are pre-installed</p> | <p><b>C</b></p>  <p><b>SHELF (1)</b></p>                 | <p><b>D</b></p>  <p><b>BASKET (1)</b></p>                        |
| <p><b>E</b></p>  <p><b>STAINLESS STEEL<br/>TOP (1)</b></p>                                 | <p><b>F</b></p>  <p><b>HANDLE (1)</b></p>   | <p><b>G</b></p>  <p><b>SIDEBAR<br/>w/4 HOOKS (1)</b></p> | <p><b>H</b></p>  <p><b>SLIP SLEEVE<br/>(32) + (2) extra</b></p> |
| <p><b>I</b></p>  <p><b>LOCKING<br/>CASTER (2)</b></p>                                     | <p><b>J</b></p>  <p><b>NON-LOCKING<br/>CASTER (2)</b></p>  | <p><b>K</b></p>  <p><b>WRENCH (1)</b></p>               |   |



*Note: The black circular plastic spacers in between Shelves are used only for packaging purposes. They are NOT needed. Please discard.*

# ASSEMBLY INSTRUCTIONS

## STEP 1

Screw CASTERS (I & J) into each BOTTOM POLE (A). Turn clockwise to screw in place.

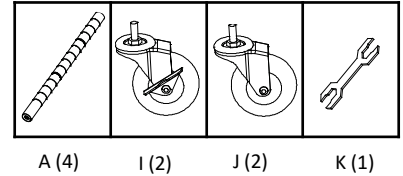

**Use provided WRENCH (K) to tighten completely. Failure to do as instructed could result in caster stem breaking.**

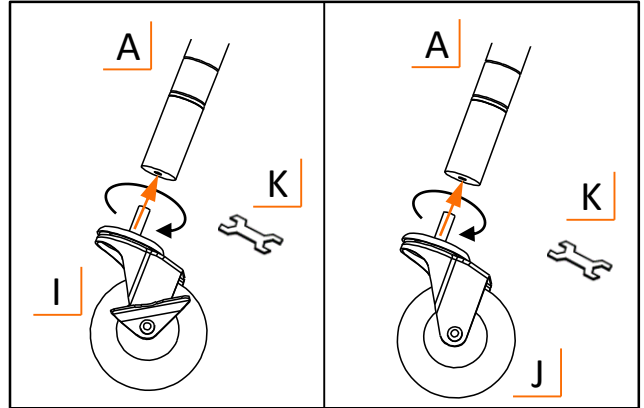

## STEP 2

On BOTTOM POLE (A), place 1 pair of SLIP SLEEVES (H) at desired height **no higher than 3<sup>rd</sup>** indentation from bottom. Make sure arrow faces up and word “TOP” is right-side up. Do this for each BOTTOM POLE (A). Make sure SLIP SLEEVES (H) height is identical for each BOTTOM POLE (A).

Note that each POLE (A & B) has slight horizontal line indentations at 1” intervals. Each SLIP SLEEVE (H) has raised horizontal lines inside designed to lock in place on POLE (A & B).

Slide pair of SLIP SLEEVES (H) until you hear a click to confirm pair is locked onto BOTTOM POLE (A). Do NOT place more than one pair on each POLE (A & B) at a time.

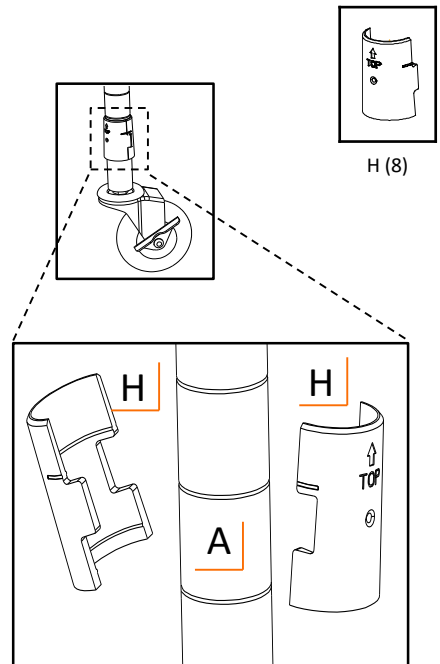

*Note: There will be a very small gap in-between two locked SLIP SLEEVES (H)—this is normal.*

# ASSEMBLY INSTRUCTIONS

## STEP 3

Place SHELF (C) on its side and slide each BOTTOM POLE (A) through each corner cylinder of SHELF (C). Make sure LOCKING CASTERS (I) are on same side and make sure corner cylinders are positioned over SLIP SLEEVES (H).

Slowly stand unit upright.

*Note:*

*Level side of SHELF (C) is TOP side.*

*Use a rubber mallet, if needed, to secure SHELF (C).*

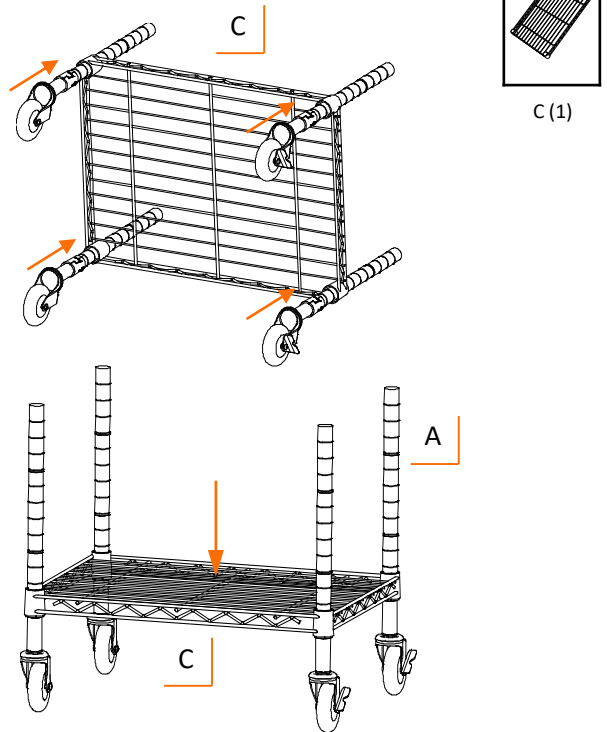

## STEP 4

Screw TOP POLES (B) into BOTTOM POLES (A) in clockwise direction.

*Note:*

*Top of each TOP POLE (B) is*

*indicated by a BLACK END CAP.*

*Pole Connectors are pre-installed in bottom of TOP POLES (B).*

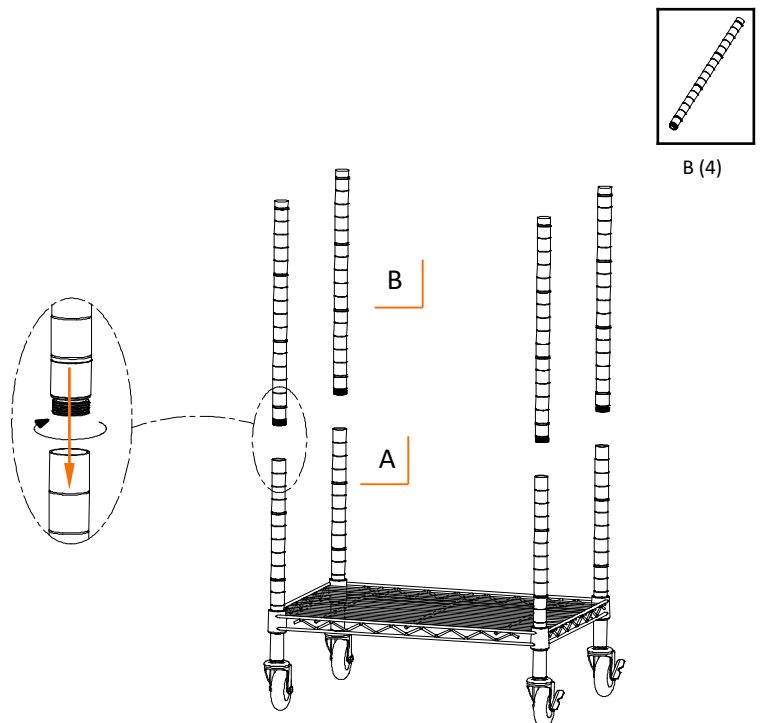

# ASSEMBLY INSTRUCTIONS

## STEP 5

Repeat STEP 2 & 3 to assemble BASKET (D).  
Make sure SLIP SLEEVES (H) height is identical.

*Note:*  
Use a rubber mallet, if needed, to secure BASKET (D).

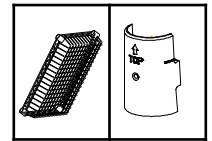
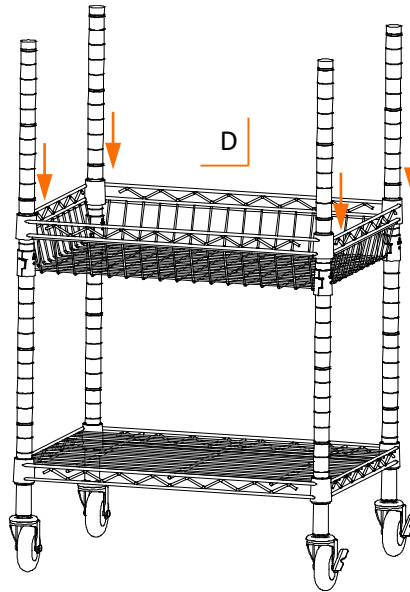

D (1) H (8)

## STEP 6

Attach one pair of SLIP SLEEVES (H) to poles on shorter side of Kitchen Cart as shown.

Slide HANDLE (F) onto poles, making sure corner cylinders are positioned over SLIP SLEEVES (H).

Repeat STEP to attach SIDEBAR (G) onto opposite side of Kitchen Cart.

*Note:*  
Use a rubber mallet, if needed, to secure HANDLE (F) and SIDEBAR (G).

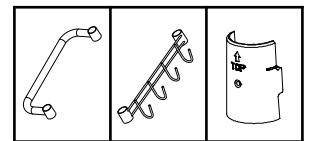
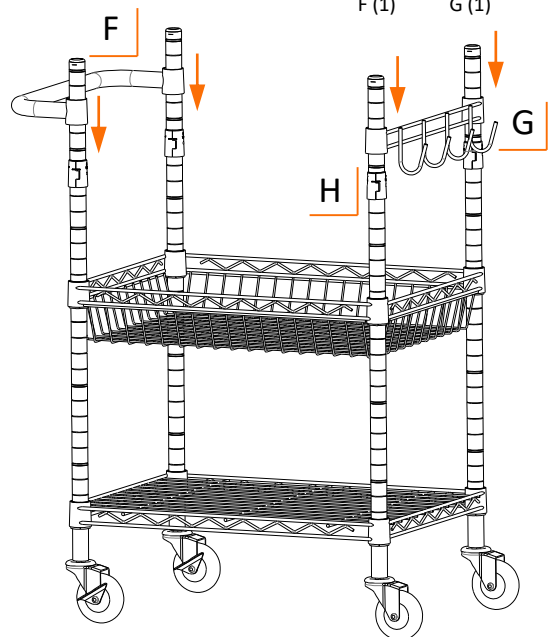

F (1) G (1) H (8)

# ASSEMBLY INSTRUCTIONS

## STEP 7

Repeat Step 2 for STAINLESS STEEL TOP (E) and place SLIP SLEEVES (H) at highest position on TOP POLES (B). Slide STAINLESS STEEL TOP (E) onto SLIP SLEEVES (H).

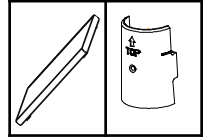

E (1)

H (8)

