

Top View

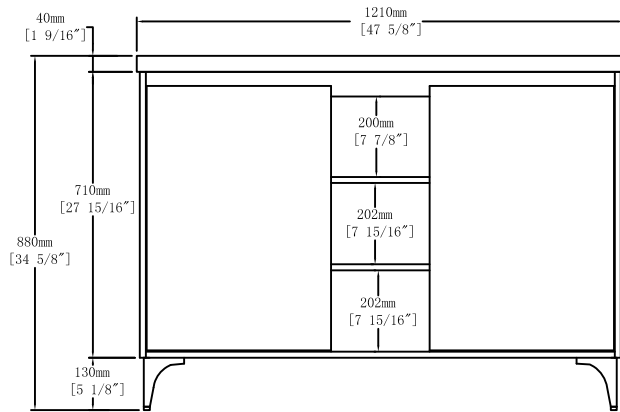

Front View

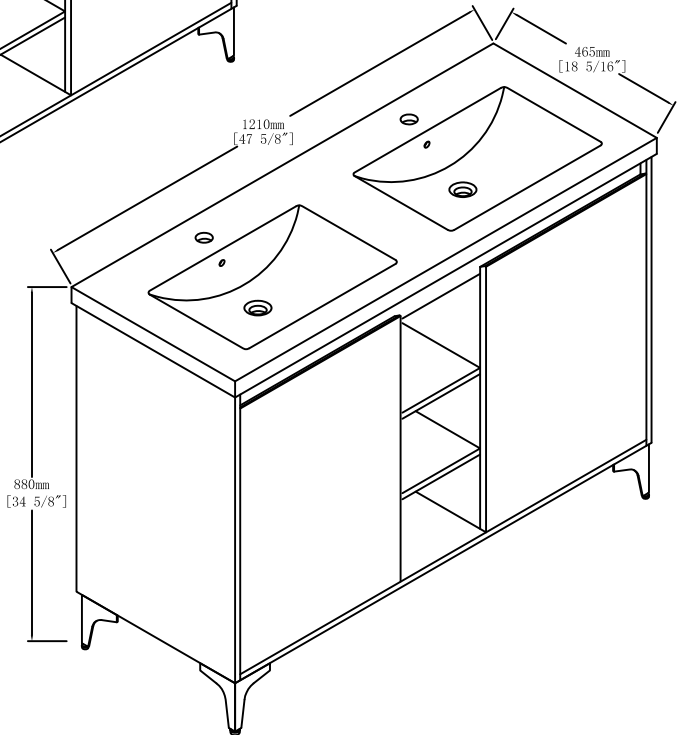
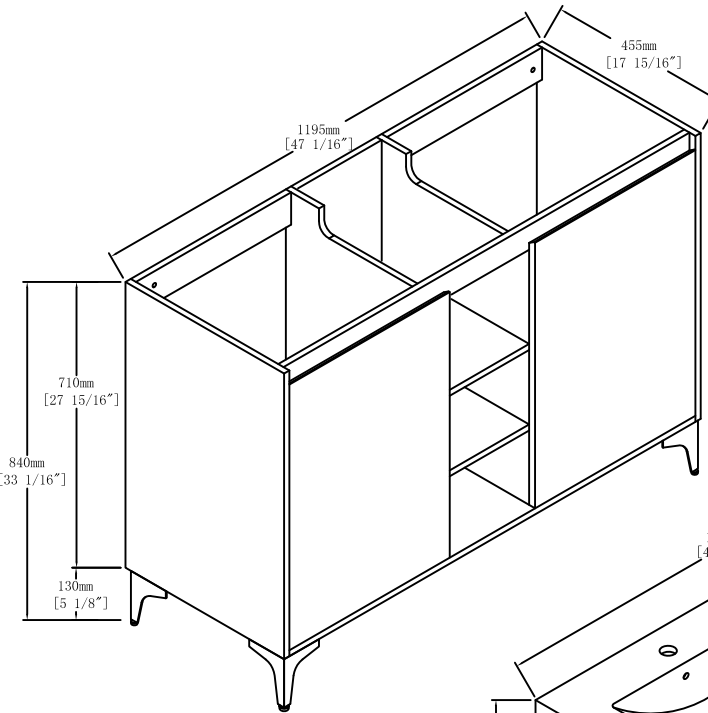
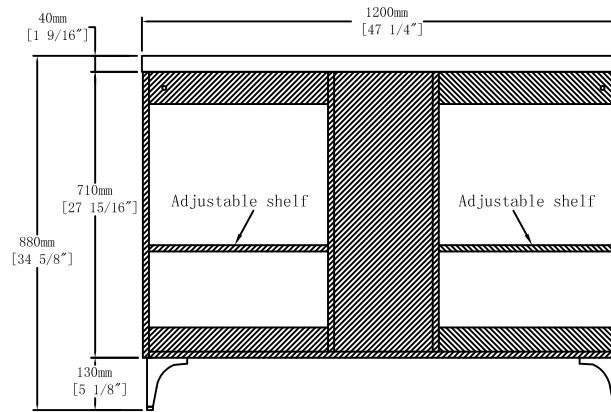

Back View

Item NO.

Version V1

Project

Date 2023-8-6