

Assembly Instructions

Caution : You must read this before you proceed.

HANGING CHAIR BASE















CAUTION : Do Not Swing on or in chair. This could cause the product to tip over resulting in possible injury. This Support Stand is NOT a TOY. Keep your child / children at bay during the assembly process.

Part List

No.	Picture	Description	Qty
A	A line drawing showing the base of the chair with a safety strip (part F) attached to it.	Base Loosely (Pre-attached with Part F)	1
B	A line drawing of a curved metal boom.	Base Booms - Curved	2
C	A line drawing of a straight metal boom.	Base Straight Boom Loosely	1
D	A line drawing of a bent metal holder.	Bent Metal Holder	1
E	A line drawing of a straight metal holder.	Straight Metal Holder	1
F	A line drawing of a safety strip.	Safety Strip	1

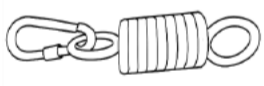
Hardware

①		Bolt(M8*20mm) and Washer	6
②		Bolt and Nut and Washer (M8*55mm)	2
③		Bolt and Nut and Bolt Cap and Nut Cap (M10*70)	3
④		Allen Key(M4)	1
⑤		Wrench (M8)	1
⑥		Wrench (M10)	2
⑦		Rubber Ring	2
⑧		U shape lock	1
⑨		Bolt and Nut (M6*45mm)	1
⑩		Bolt	1
⑪		Spring with safty lock	1
⑫		Allen Key(M6)	1

Assembly preparation

Before Beginning Assembly:

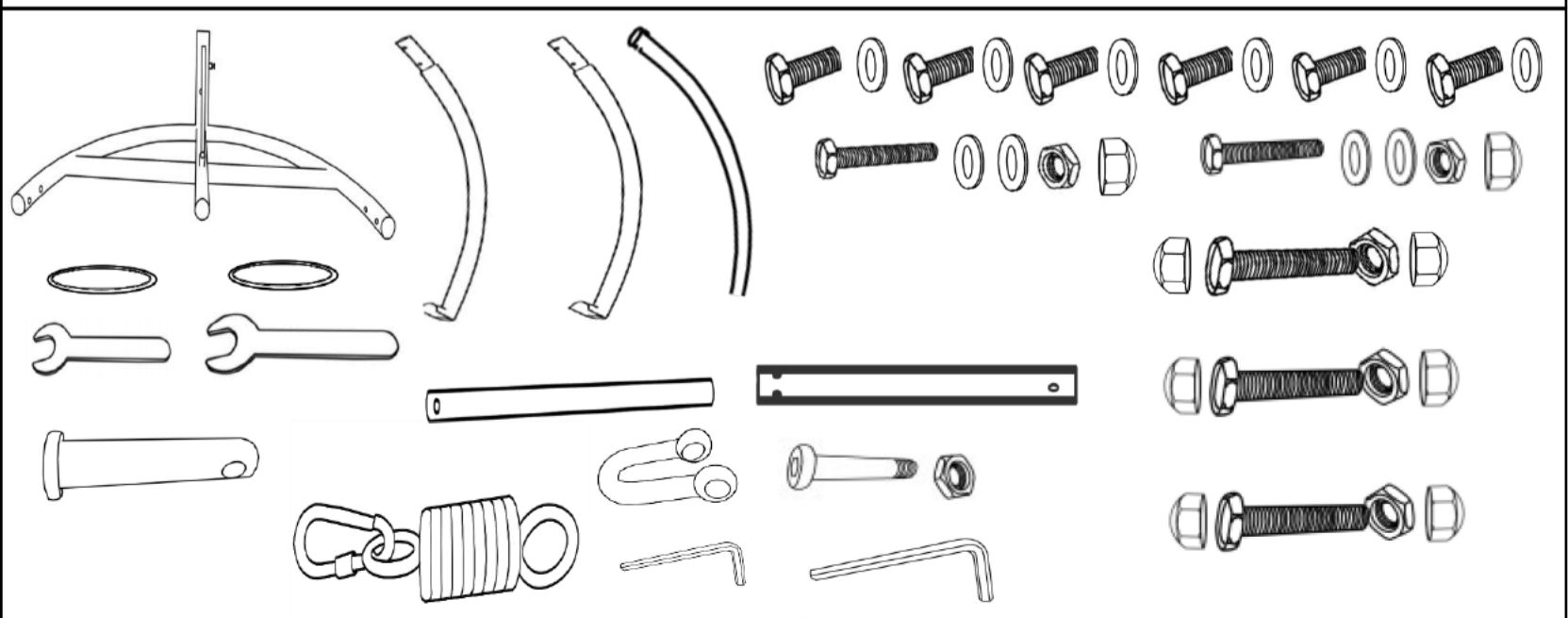



- Read instructions, cover to cover-



- Have 2 adults on hand for assembly-



- Do not assemble on flooring or carpet-



- Assemble on a clean non-marring surface (packing foam)-



- Save all packaging until finished-

Assembly Steps

Overview

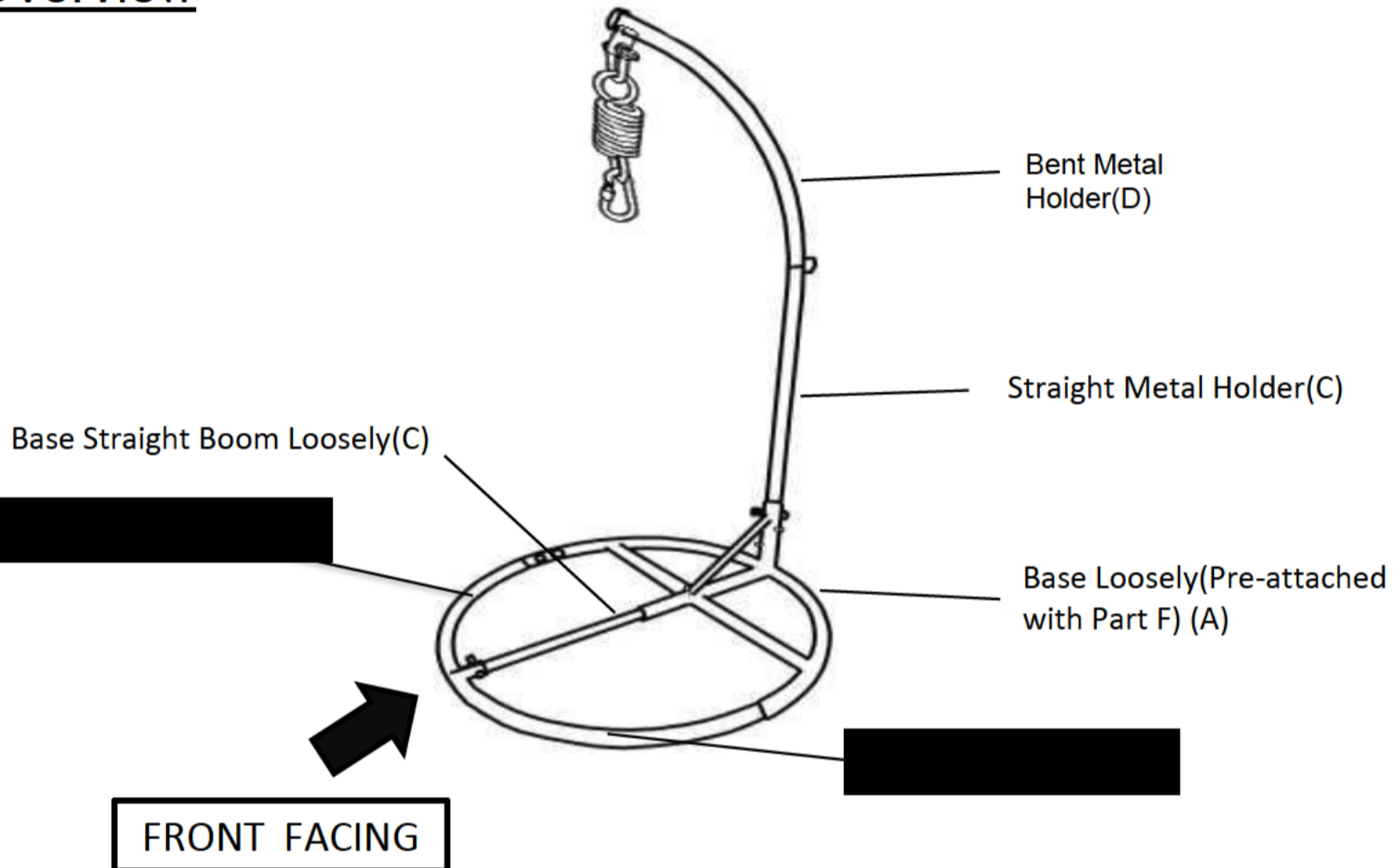

This Stand has multiple parts and may require up to 20 minutes to assemble. To give you an overview of the Table parts, the above picture is to help you put the various parts into perspective. Please read through the instructions below to familiarise yourself with the parts and steps before assembly.

Step 1

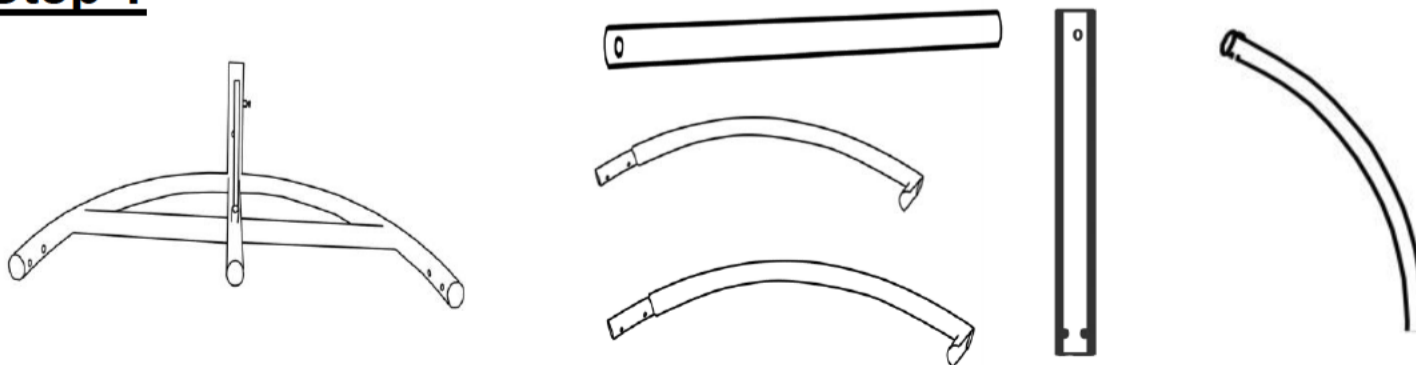

Open the carton and place all the parts on a clean, non-marring surface.

Step 2

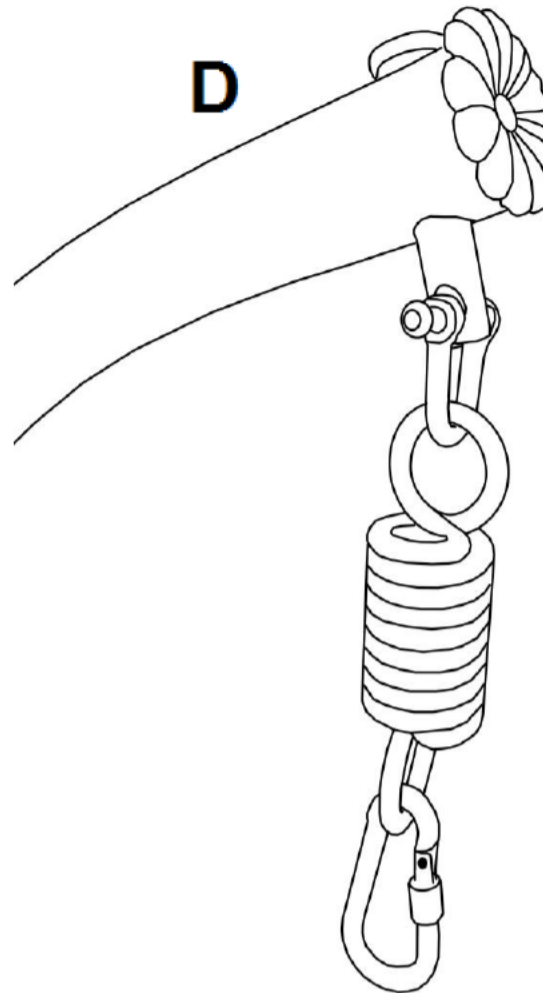
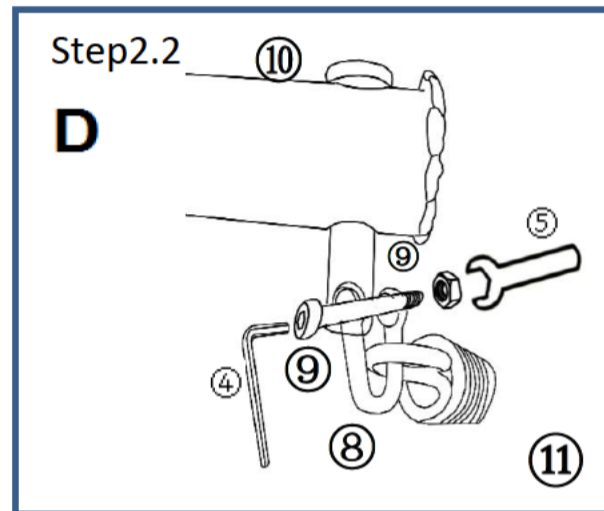
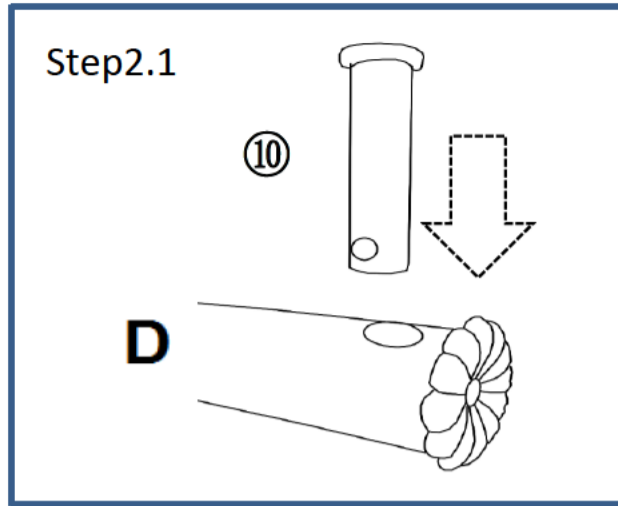

Step 2.1: Attached Bolt(⑩) to Bent Metal Holder(D).

Step 2.2: Attached U shape Lock with Spring & Safety lock(⑪) to Bolt(⑩) using Bolt and nut(⑨) with Allen key (④) and Spanner(⑤).

Tighten Bolt

Step 3

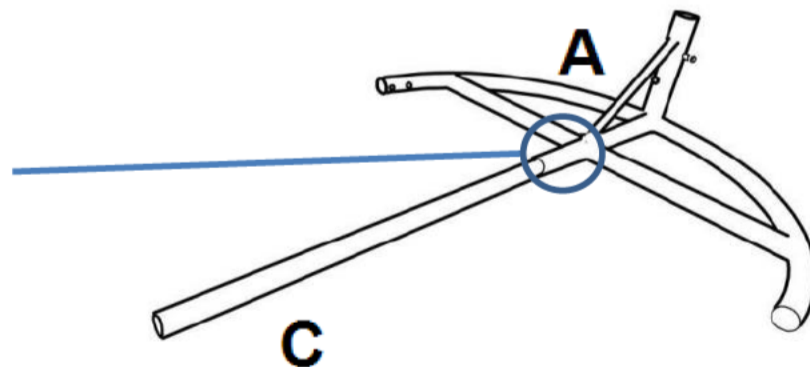
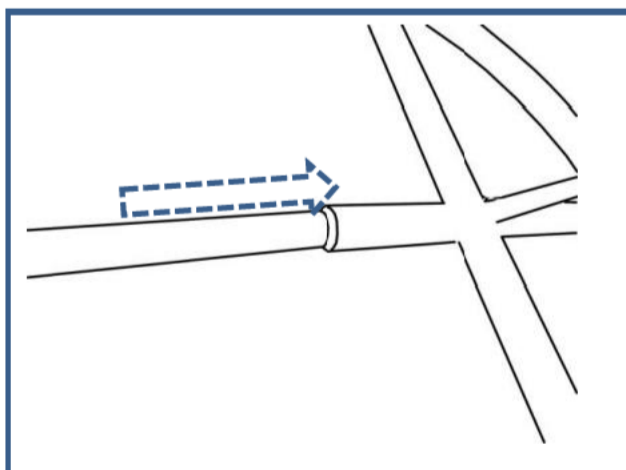

Attached Base Straight Boom Loosely (C) to Base Loosely(A)

Attention: Should Push C to the end of bottom of A

Step 4

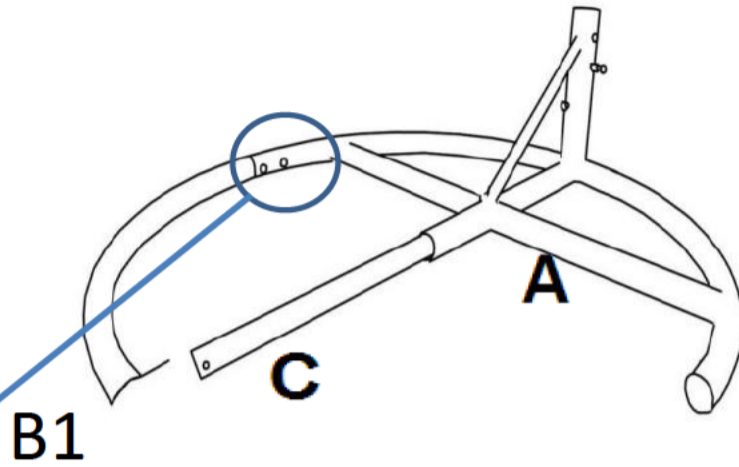
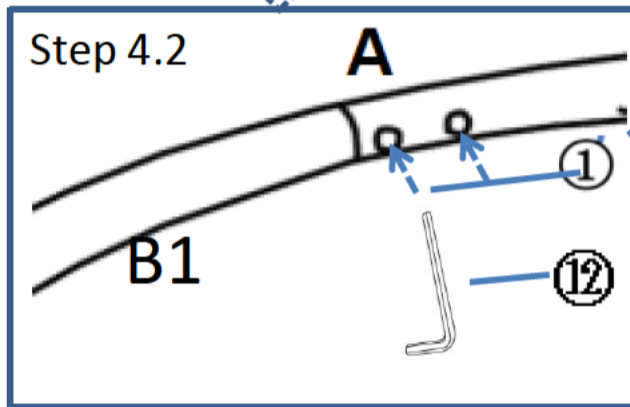
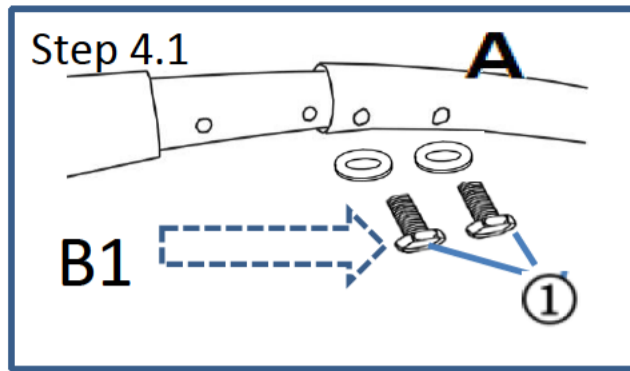

Step 4.1: Attached Base Booms - Curved (B) to Base Loosely (A)(Pre-attached with Part (1)) Using bolts and washer (1) with Wrench (12).
Attention: B have B1 and B2, There is a label in products, pls pay attention: B1 to B1, B2 to B2. Don't Fully tighten the nuts in this step.

Step 5

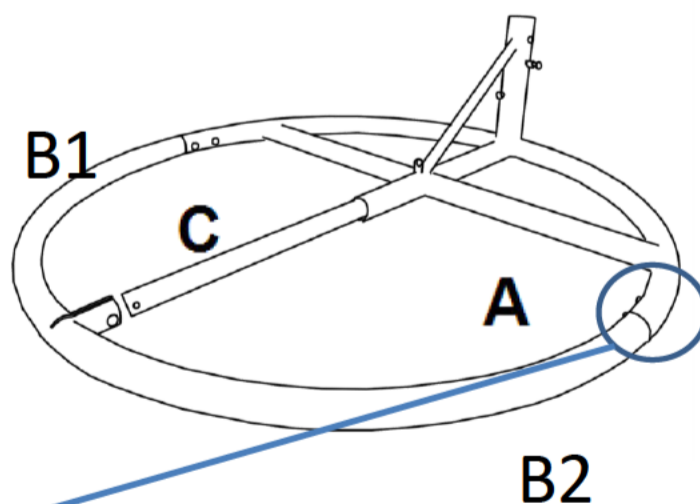
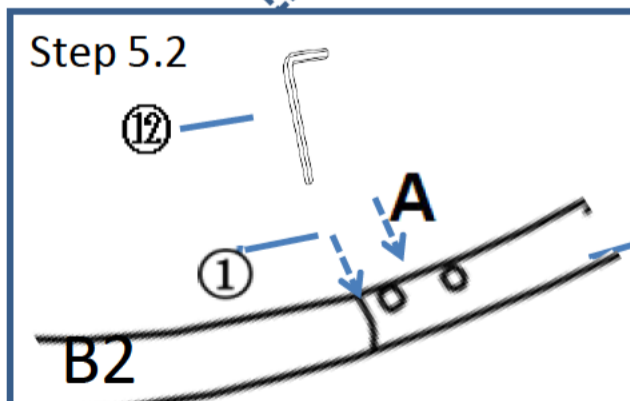
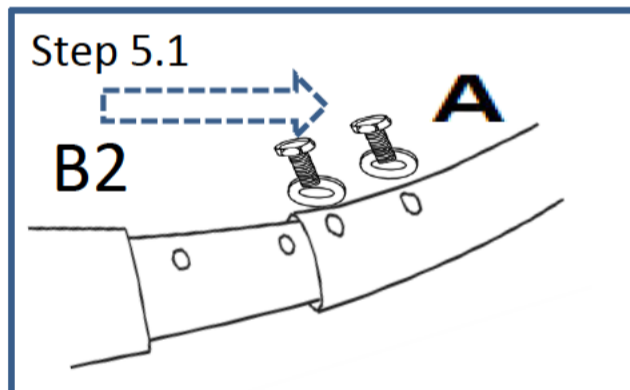

Repeat Step 4.

Attention: B have B1 and B2, There is a label in products, pls pay attention: B1 to B1, B2 to B2. Don't Fully tighten the nuts in this step.

Step 6

Step 6.1

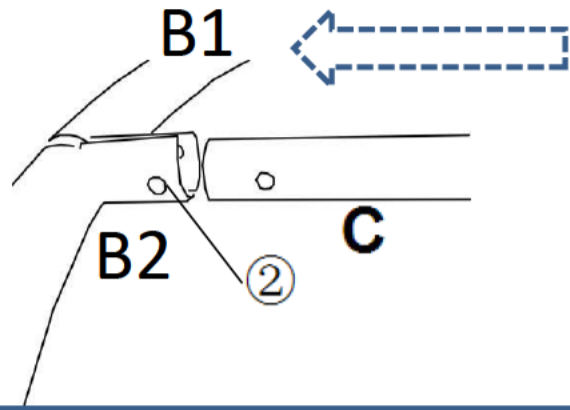

Step 6.2

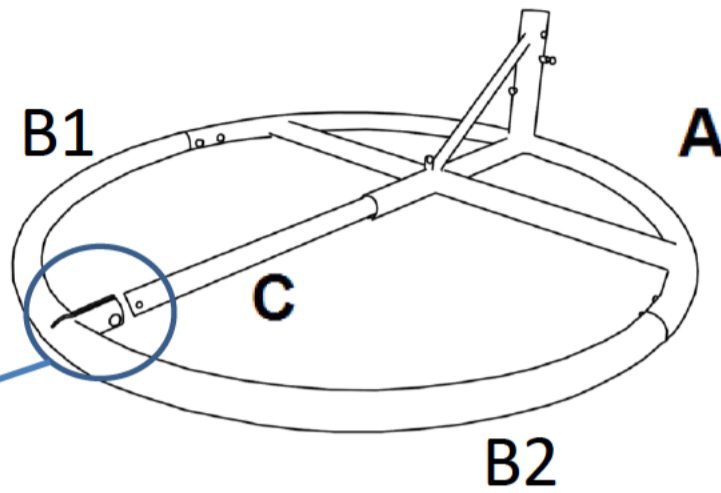
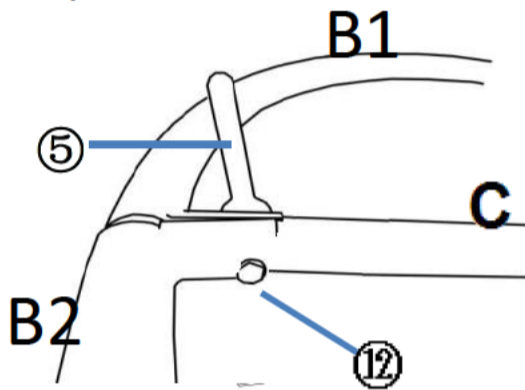

You should drag out Part (C) a little in this step, then attached Base Straight Boom Loosely (C) to Base Booms - Curved (B) using Bolt and Nut and Washer (2) with Wrench (5) and Allen Key (12). Fully tighten all nuts.

Step 7

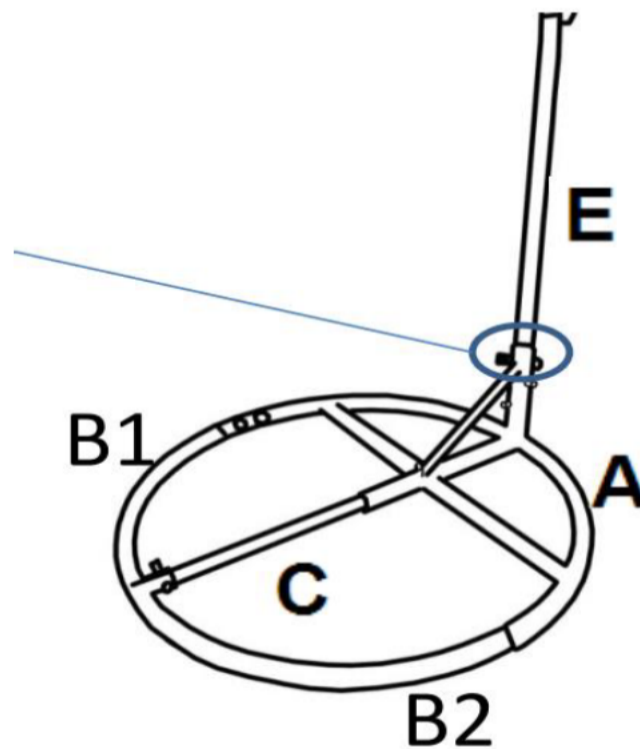
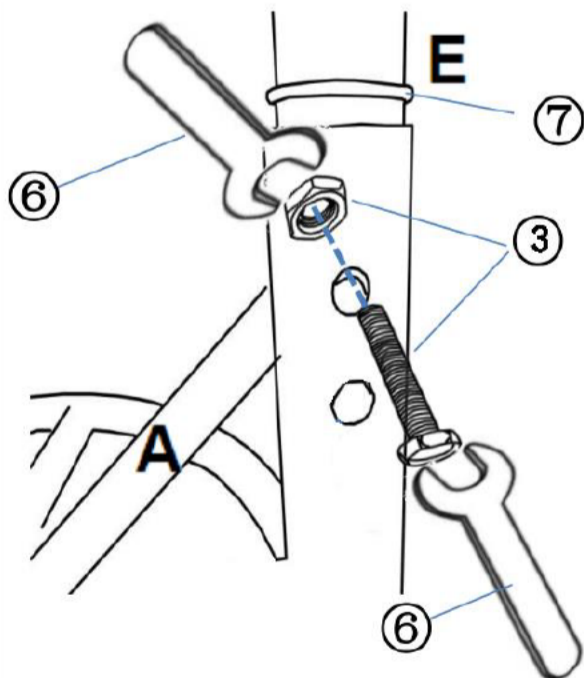

Attached Straight Metal Holder (E) to Base Loosely (A) using Wrench (6) with Nuts set (3). Then, Move the Rubber Ring(7) down the Lower Pole(E) until it is flush with the top of the Base(A).

PS: You should loosen nut using Wrench(6) before this step.

Step 8

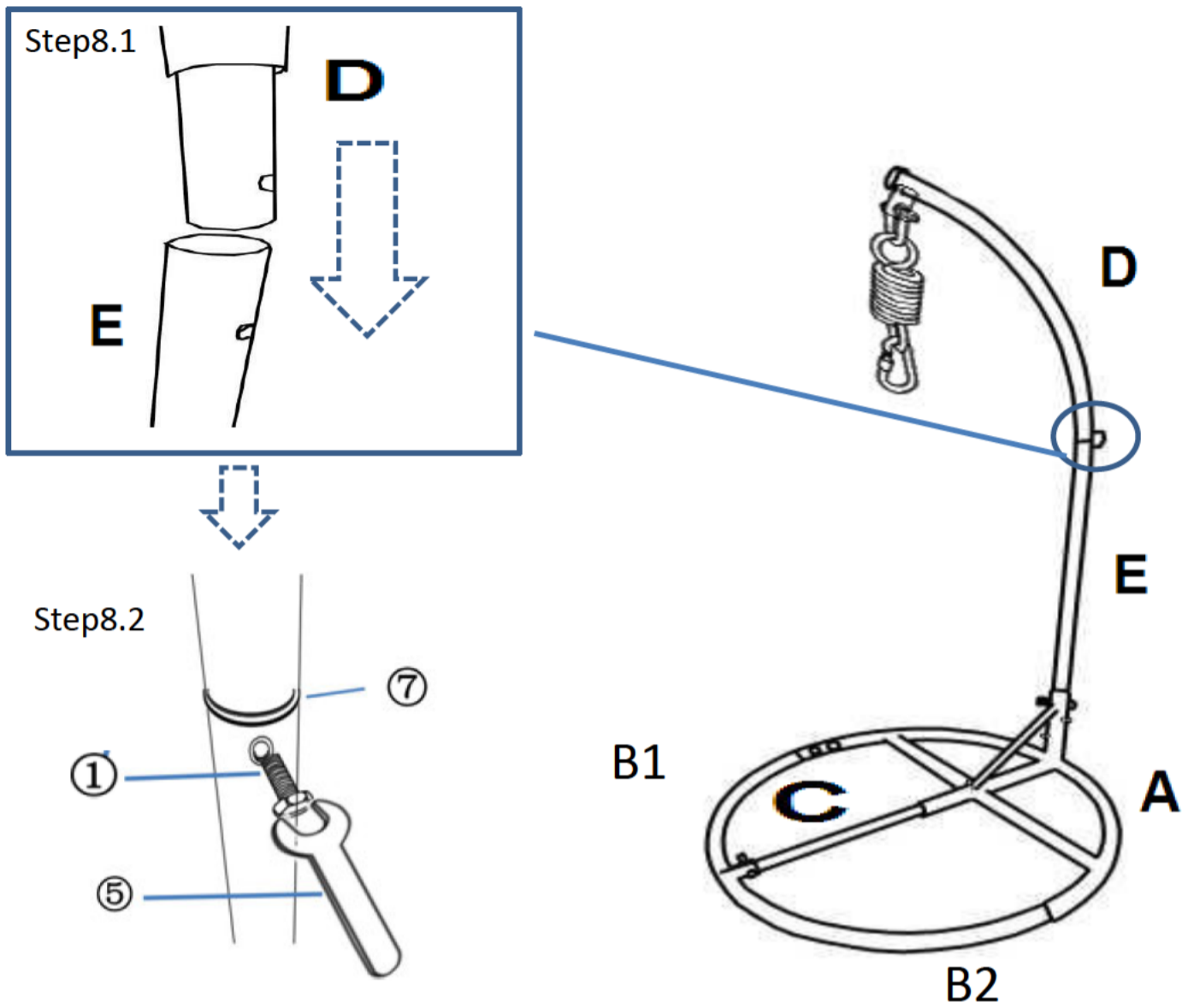

Move the Rubber Ring(⑦) between Bent Metal Holder(D) and Straight Metal Holder (E). Then Attached Bent Metal Holder (D) to Straight Metal Holder (E) using Wrench (⑤) with bolt and washer(①).
Attention: Fully tighten nuts.

Step 9

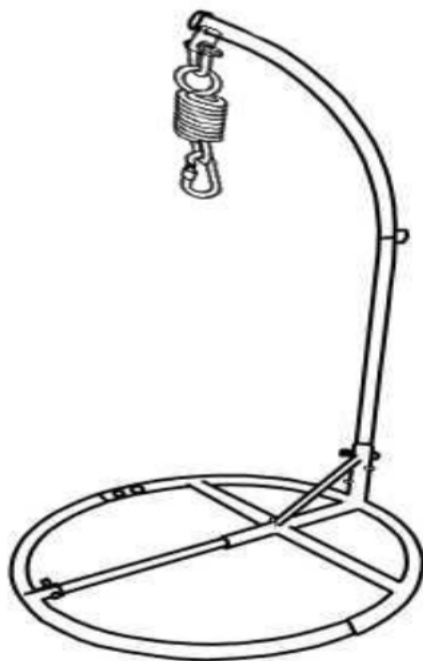

The stand are ready to use.

Step 10

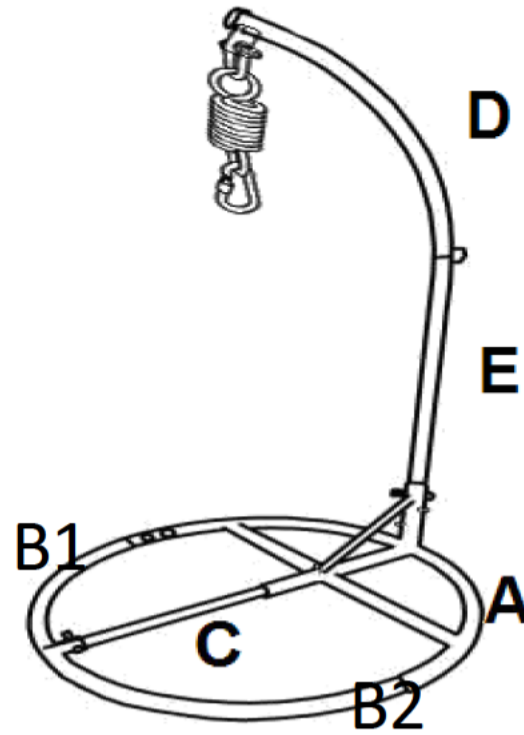
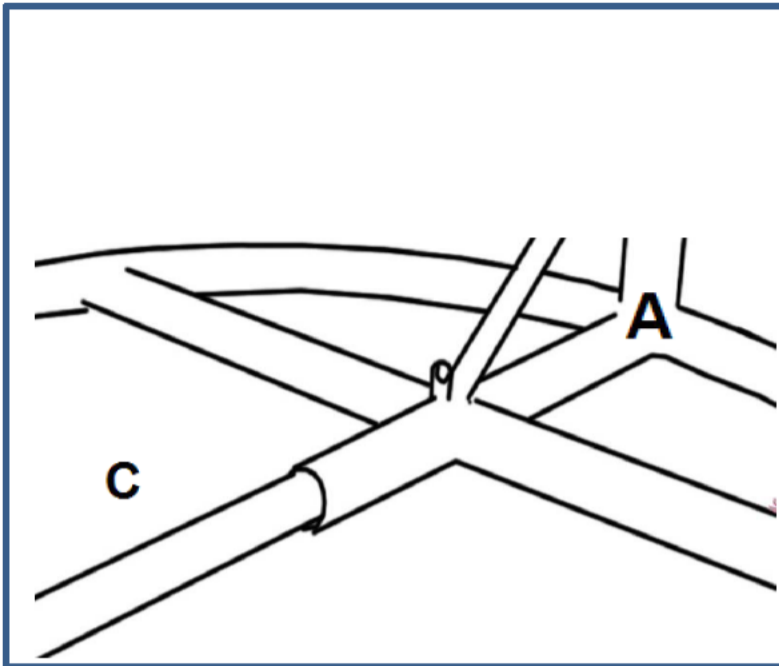

You should to fasten the safety strip (F) before using .

Step 11

Step11.1

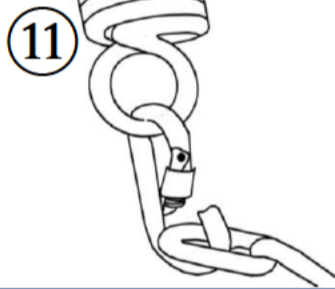



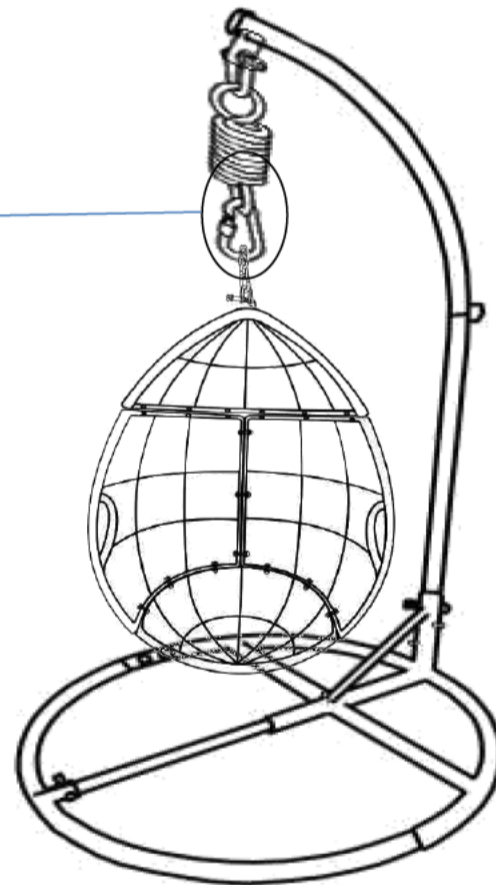
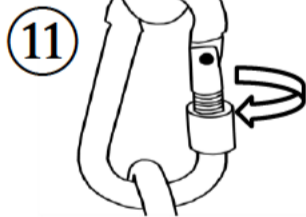













Step11.2



Lift the Basket and hang the Iron Chain on the Spring of the Hanging Chair Base. And Screw the Safety lock tightly.
Use the Safety Rope to lock up the middle rattan warp at the bottom of the Basket as shown above.
Screw up the Carabiner to secure the Basket
Note: This Step should be completed with 2 adults.

Care & Maintenance

-   ● Do not put hot items directly on furniture surface
 -   ● Do not clean furniture with harsh cleansers or polish.
 -   ● To obtain the longest lifespan of your outdoor products, minimizing exposure to direct sunlight is recommended.
 -   ● Children should not climb or jump on the furniture.
 -   ● Do not write on furniture without a padded barrier to protect the surface.
 -   ● To obtain the longest lifespan of your outdoor products, avoid extended and lengthy exposure to rain, snow, and direct sunshine. Whenever possible cover the product and /or place under patio or awnings.
 -   ● Not for commercial use. For residential use only .
 -   ● Stains may be removed with mild soap solution and damp cloth.
-

-   ● Dust and pick-up spills using a clean, non-colored, lint-free cloth .