

---

## **INSTALLATION INSTRUCTIONS**

---

MANUFACTURING QUALITY  
CEILING FANS SINCE FOREVER.

**Important: Please read and save these instructions before installation**

### Basic Product Specifications

Model	ADC523PN-FM	Voltage	120V
Fan Blade Span	52"	Rated Wattage	Fan 24W
Gross Weight	13.5lbs.	Motor RPM	55-155rpm
Maximum Airflow	5070CFM	Maximum Noise	55dB(A)

**U.S. Patent Nos.: 10,511,206 and 11,296,561.  
Other Patent(s) Pending.**

### Questions

Have questions about our products? Contact us and talk to our helpful tech support team.

### Technical Support

Business Hours:  
Monday - Friday (Holidays observed).  
**9:00 am to 5:30 pm PST.**

**This Ceiling Fan is :**



10 Speed Options



Forward Reverse  
Fan Direction

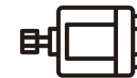

ADC Motor, stable & silent,  
suitable for indoor use



Built with premium materials  
for durability & power



Remote Control

## SAFETY PRECAUTIONS

---

- Before you begin installing the fan, shut power off at the circuit breaker of the fuse box.
- Make sure that all electrical connections are in accordance with National Electrical Code, ANSI/NFPA 70 and local codes. Hire a licensed electrician if you are unfamiliar with installing electrical wiring.
- Make sure the installation site you choose allows the fan blades to rotate without any obstructions. Allow a minimum clearance of 2.1m (7 feet) from the floor and 18 inches from the tip of the blades to the wall.
- The outlet box and support structure must be securely mounted and capable of reliably supporting a minimum of 35 pounds. Use only U.L. listed outlet boxes marked "Acceptable for Fan Support of 15.9 kg (35 lbs) or less".
- Before and after you install the fan, make sure that all mounting components are secured to prevent the fan from falling.
- Do not insert anything into the fan blades while the fan is operating.
- To change the direction of the rotation of the blades, the fan must be in operation mode.
- All set screws must be checked and retightened where necessary before installation.
- After making the wire connections, the wires should be spread apart with the grounded conductor and the equipment-grounding conductor on one side of the outlet box and the ungrounded conductor on the other side of the outlet box.
- The splices after being made should be turned upward and pushed carefully up into the outlet box. Conductor wiring identified as grounded is to be connected to a grounded conductor of power supply. Conductor wiring identified as ungrounded conductor is to be connected to an ungrounded conductor. Conductor wiring identified for equipment grounding is to be connected to an equipment-grounding conductor.
- This device complies with part 15 of the FCC Rules. Operation is subject to the following two conditions: (1) This device may not cause harmful interference, and (2) this device must accept any interference received, including interference that may cause undesired operation.

## SAFETY PRECAUTIONS

---

- **CAUTION:** Read all instructions and safety information before installing your new fan. Review accompanying assembly diagrams.
  - **WARNING:** To reduce the risk of fire, electric shock, or personal injury, mount to outlet box marked "Acceptable for Fan Support of 15.9 kg (35 lbs) or less" and use mounting screws provided with the outlet box.
  - **CAUTION:** To reduce the risk of injury, use only the screws provided with the outlet box in conjunction with the lock washers.
  - **WARNING:** To reduce the risk of personal injury, do not bend the blade bracket when installing the brackets, balancing the blades, or cleaning the fan. Do not insert foreign objects in between rotating fan blades.
  - **CAUTION:** To reduce the risk of electric shock, disconnect the electrical supply circuit to the fan.
  - **WARNING:** To reduce the risk of fire or electric shock, this fan must be installed with a general use, non-dimmable, single gang, isolating wall control/switch.
  - **WARNING:** To reduce the risk of fire or electric shock, do not use this fan with any solid-state speed control device.
- NOTE:** The important safeguards and instructions appearing in this manual are not meant to cover all possible conditions and situations that may occur. It must be understood that common sense, caution and care are factors which cannot be built into this product. These factors must be supplied by the person (s) installing, caring for and operating the unit.
- **CAUTION:** The fan is designed for this specific application and can overheat if serviced by untrained personnel. If any servicing is required, the product should be returned to an authorized service facility for examination or repair.

## Fan Diagram

---

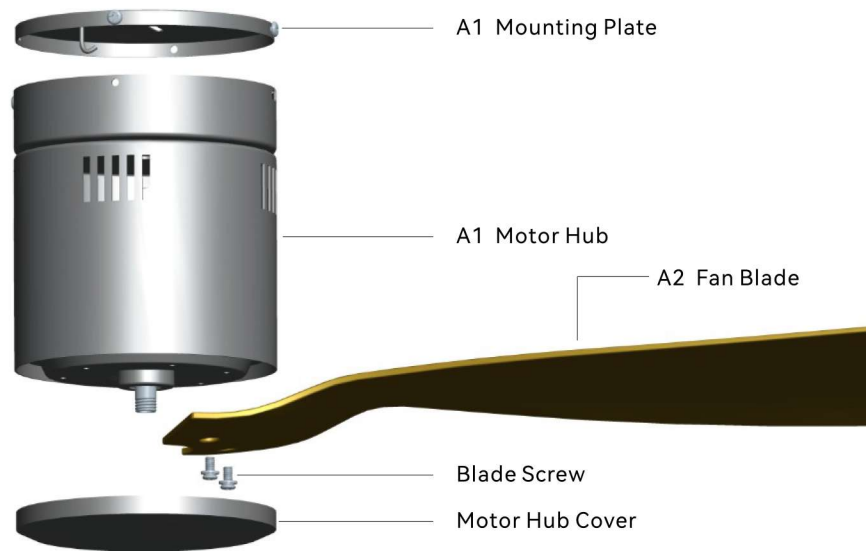

## Table of Contents

---

08	<b>Disassembly of Motor</b>
09	<b>Mounting Options</b>
10	<b>Wiring</b>
11	<b>Securing the Fan</b>
12	<b>Fan Blades</b>
13	<b>Motor Hub Cover / Power On</b>
14	<b>Remote Control</b>
15	<b>Troubleshooting</b>
16	<b>Care &amp; Cleaning / FCC</b>

## Tools & Materials Required



External  
hexagonal wrench



Phillips  
screwdriver



Step  
ladder

## Package Contents

CARRO

Before installing, please check to make sure you have received all the necessary components for installation.

A1



A2



QTY:4  
ST5X24  
Setscrew  
QTY:2  
Wire Nut



QTY: 6  
Blade Screw



Remote  
Control

## Installation

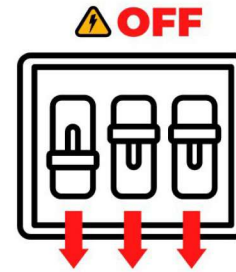

**WARNING:** To avoid serious injury or death, turn off the power at the circuit breaker before installing the fan.

### 1. Disassemble the Motor

1.1 Take the motor assembly out of the box, use a screwdriver to loosen and remove the canopy screws and the mounting plate. Save the canopy screws for later use.

1.2 Rotate and take out the motor hub cover as shown in Fig 1.2.



Fig 1.1



Fig 1.2

## Installation: Mounting Options

### 2. Install the Mounting Plate

You have two options for mounting plate installation. Pick which one works best for your location.

**WARNING:** Turn off the power from the breaker circuit first!

**Note:** For better fan performance, make sure the mounting plate is level.

**Option 1:** Fasten the mounting plate with the ST5×24 wood setscrews (included) when securing to the wooden ceiling beam or support structure with an approved electrical outlet box as shown in Fig 2.1.

**Option 2:** Use machine screws (provided with outlet box) and washers when securing to an existing ceiling fan-rated outlet box. If the mounting plate is installed at the outlet box, it should be installed on the outlet box with the screws that came with your outlet box itself. Pull the supply wires (the black, white and ground wires) out of the outlet box and through the hole in the mounting plate and lay them to the side.

**WARNING:** DO NOT use the plastic outlet box. Use only U.L. listed outlet boxes marked "Acceptable for Fan Support of 15.9 kg (35 lbs) or less".

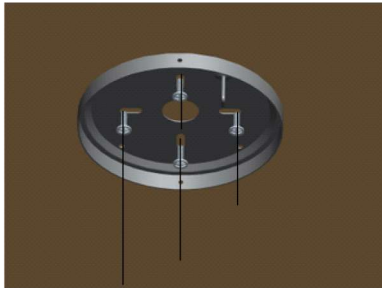

Fig 2.1



Fig 2.2

## Installation: Wiring

### 3. Hang the Fan

Carefully lift the fan-motor assembly. Hang the motor assembly on the hook of the mounting plate by utilizing one of the holes at the outer rim of the motor housing so that it is securely suspended.



### 4. Connect the Wiring

The Green/Yellow wire from mounting plate connects with the supply Ground wire using the wire nut.

Connect the White wire to the supply White (Neutral) wire using a wire nut, connect the Black wire to the supply Black/Red (Hot/Live) wire using a wire nut.

Then hide them inside the motor housing. (Make sure all the wires are connected to the correct colors as shown in Fig 4.1)

Attach the other end of safety rope to a safe place.



Fig 4.1

## Installation: Securing the Fan

### 5. Secure the Fan

5.1 Reinstall two of the four canopy screws (located across from each other) that were removed in step 1 to the mounting plate, but DO NOT tighten them yet.

5.2 Using both hands, lift the fan body from the hook. Align the two key slots in the top of the motor assembly with the two loosened screws on the mounting plate.

5.3 Push the fan motor assembly up and turn it counterclockwise to lock in the mounting plate. Tighten the two screws. Reinstall the other two canopy screws into the remaining two holes and tighten the four screws firmly.

**WARNING:** Falling fan hazard, make sure all screws are tightened to secure the fan motor assembly.



Fig 5.1

## Installation: Fan Blades

### 6. Install the Fan Blades

6.1 Locate 6 blade attachment screws in the hardware pack. Install the blade screws to secure each blade to the fan.

6.2 Repeat for the remaining blades. Make sure all the screws are firmly tightened. The installation of the blades is shown in the Fig 6.2.



Fig 6.1



Fig 6.2

## Installation: Motor Hub Cover & Power on

### 7. Reinstall the Motor Hub Cover

7.1 Rotate the motor hub cover until it locks back to the motor shaft tightly.

7.2 After installation, the motor hub cover is shown in Fig 7.2.

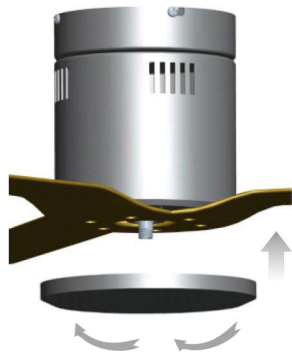

Fig 7.1



Fig 7.2

### 8. Power On

At this time, the ceiling fan has been installed. Turn on the power supply from the breaker circuit of the main switch or the room where the ceiling fan is installed.

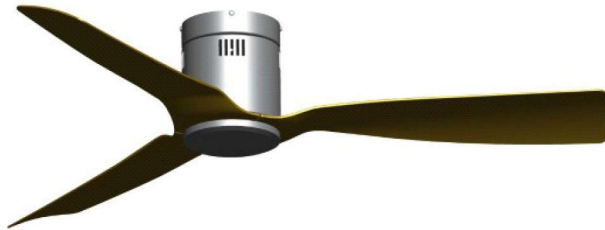

## Remote Control Instructions

### Pair the Remote Control to Your Fan

Power on the fan and pair the remote to the fan within 1 min. To pair remote to fan, press and hold  button for 3-5 secs to pair remote to the fan. Then test it.

### Remote Control Button Definitions



Stops the fan from rotation.



Switches between summer mode and winter mode.

· Summer mode - (Counter-clockwise) A downward airflow creates a cooling effect.

· Winter model - (Clockwise)

An upward airflow moves warm air away from the ceiling area and redistributes it around the living space.



Turns the fan on and decreases fan speed.



Turns the fan on and increases fan speed.

Speed 10 Turns the fan on at highest speed.

Speed 1 Turns the fan on at lowest speed.



Turns the fan on/off.

**Note:** Power on the fan and pair the remote to the fan within 1 min. To pair remote to fan, press and hold  button for 3-5 secs to pair remote to the fan. Then test it.



When the fan is on, press this button and the fan will be shut down 1 hour later.



When the fan is on, press this button and the fan will be shut down 2 hours later.



When the fan is on, press this button and the fan will be shut down 4 hours later.



When the fan is on, press this button and the fan will be shut down 8 hours later.

**WARNING:** Do not expose the remote control to direct contact with water.



## Troubleshooting

Try these troubleshooting steps before contacting Customer Service. For additional operation, maintenance, and troubleshooting information, please contact our customer service center.

SYMPTOM	POSSIBLE SOLUTION
Fan not spinning	<p>① Make sure the fan is getting power. ② Check your circuit breaker or fuse panel and wall switch for functionality. ③ Check to make sure the fan wires are correctly connected to the house wires. ④ Remote control must be paired with the fan within 1 minute after connecting the fan to the electricity. ⑤ If you have paired the remote but the fan still does not work or couldn't pair the remote to the fan, try to reset the fan: to reset the fan, cut the power for 10 minutes, then turn the power on and press the pairing button (Ⓜ) on the remote for 3-5 seconds. Then test it. ⑥ Use a multi-meter and test the wiring harness to see if there is any electrical output. ⑦ All the pin wiring on the circuit board must be inserted tight and in the correct position. ⑧ Remote needs to be paired with the fan first. ⑨ Make sure the fan blades spin freely. ⑩ If you're using a wall control, check the power to the breaker from your control and try working your ceiling fan manually. (Normal switch only for the fan power on/off)</p>
Fan not working	Make sure the whole fan is powered.
The fan is noisy and wobbling	<p>① Check if the blade screws are NOT rubbing against any part of the motor housing. ② Check the pin wires are NOT connected against any moving parts. ③ Check the down fan cup is NOT hitting the motor. ④ Confirm the canopy is NOT touching the ceiling while the fan is in operation. ⑤ Check the down rod is NOT slanted. ⑥ Tighten any loose screws on the fan blades, motor coupling, down rod, brackets and mounting hardware. ⑦ Confirm the hanger ball is firmly seated in the mounting bracket. ⑧ The ceiling beam must meet the minimum tensile test strength of 30KG for installation. ⑨ Make sure the blades and brackets are NOT bent or deformed. ⑩ Verify the wire connections are not rattling against each other. ⑪ Verify the fan blades are not cracked. If the fan blades are cracked, replace the damaged blades with a new blade set from the same brand as your ceiling fan to ensure compatibility.</p>
Unable to pair remote	<p>① Check if the wires are connected in the correct position or not. ② Check the batteries in the remote. ③ Disconnect the power for 10 minutes, reconnect the power and pair the remote with the fan immediately, within 1 minute.</p>
Fan turning on or off by themselves	<p>① Confirm the circuit breaker is not malfunctioning. ② Verify the wire connections are not frayed. ③ Cut the fan power for 10 minutes then power on again. ④ All the pin wiring on the circuit board must be inserted tight and in the correct position.</p>

## Care & Cleaning

- 1 Check the support connections, brackets, and blade attachments twice a year. Make sure they are secure. Because of the fan's natural movement, some connections may become loose over time. It is not necessary to remove the fan from the ceiling.
2. Clean your fan periodically. Use only a soft brush or lint-free cloth to avoid scratching the finish. The plating is sealed with a lacquer to minimize discoloration or tarnishing.
3. (Optional) Apply a light coat of furniture polish to the wood blades.
4. (Optional) Cover small scratches with a light application of shoe polish.

### DO NOT:

1. Use water when cleaning. Water could damage the motor, or the wood, or possibly cause an electrical shock.
2. Apply oil to your fan or motor. The motor has permanently lubricated sealed ball bearings.

**WARNING:** Power off the fan before performing maintenance or cleaning the fan.

## FCC Statement

**Note:** This equipment has been tested and found to comply with the limits for a Class B digital device, pursuant to part 15 of the FCC Rules. These limits are designed to provide reasonable protection against harmful interference in a residential installation. This equipment generates, uses and can radiate radio frequency energy and, if not installed and used in accordance with the instructions, may cause harmful interference to radio communications. However, there is no guarantee that interference will not occur in a particular installation. If this equipment does cause harmful interference to radio or television reception, which can be determined by turning the equipment off and on, the user is encouraged to try to correct the interference by one or more of the following measures:

- Reorient or relocate the receiving antenna.
- Increase the separation between the equipment and receiver.
- Connect the equipment into an outlet on a circuit different from that to which the receiver is connected.
- Consult the dealer or an experienced radio/TV technician for help.

**WARNING:** Changes or modifications to this unit not expressly approved by the party responsible for compliance could void the user's authority to operate the equipment.