

ASSEMBLY INSTRUCTIONS

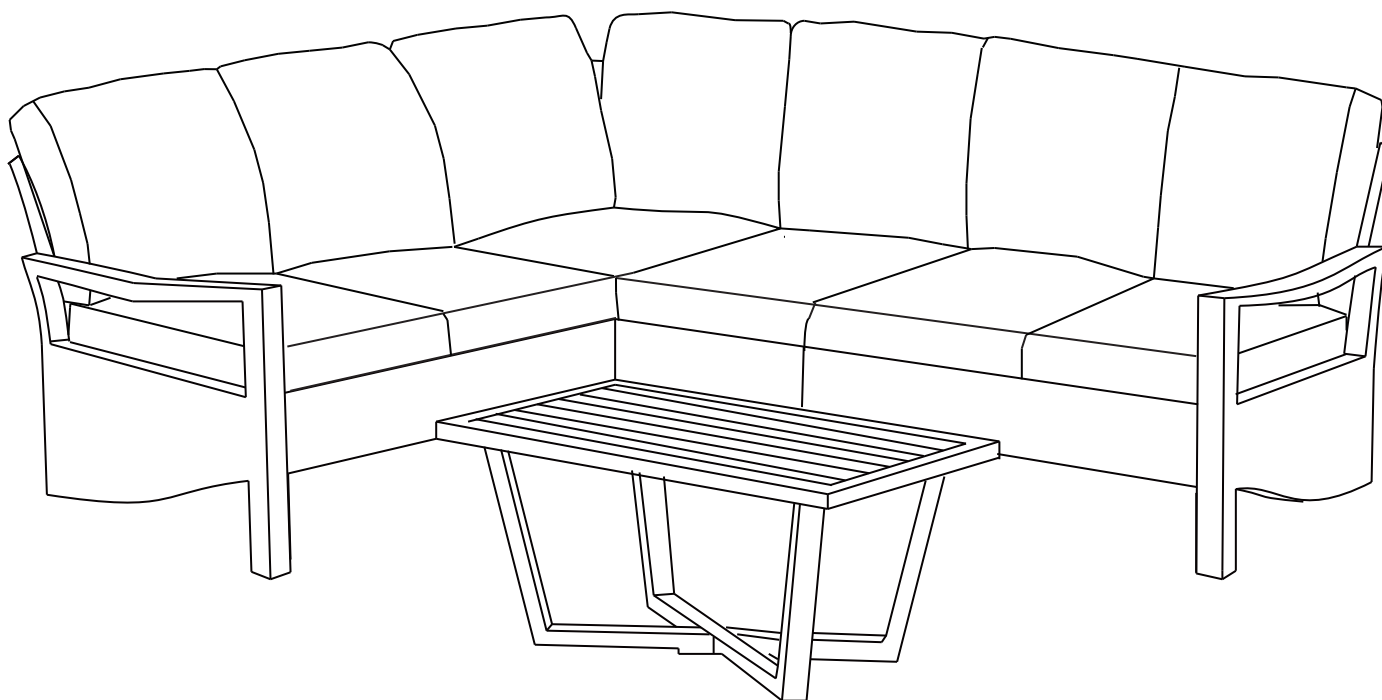

PACKAGE CONTENTS

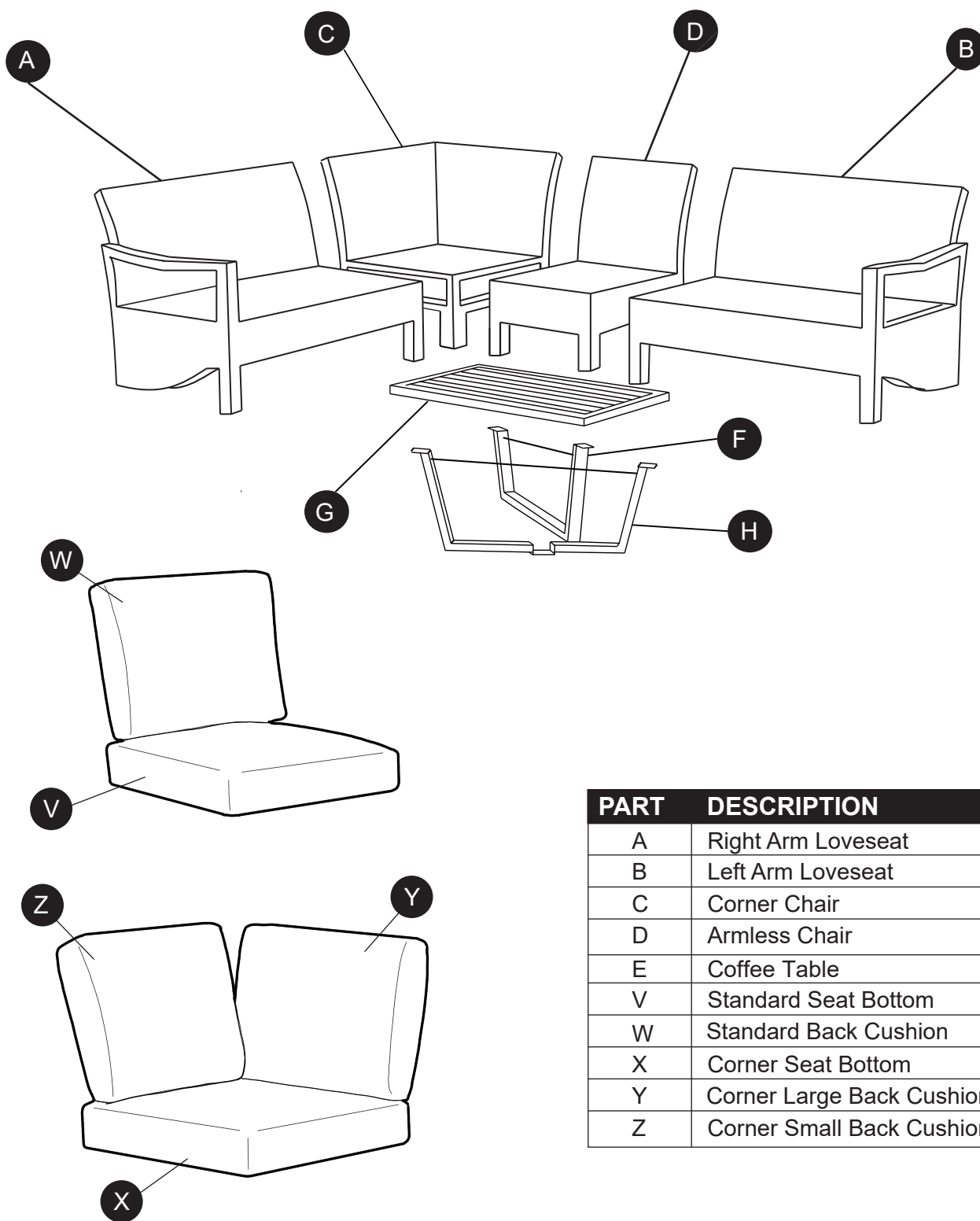

PART	DESCRIPTION	QTY
A	Right Arm Loveseat	1
B	Left Arm Loveseat	1
C	Corner Chair	1
D	Armless Chair	1
E	Coffee Table	1
V	Standard Seat Bottom	5
W	Standard Back Cushion	5
X	Corner Seat Bottom	1
Y	Corner Large Back Cushion	1
Z	Corner Small Back Cushion	1

Note: You will also have 6 plastic bags containing your fabric covers.

5 Bags: Standard Seat Covers (1 bag contains both 1 bottom seat and 1 back cover)

1 Bag: Corner Seat Covers (1 bag contains 3 covers: 1 bottom and 2 back covers)

PACKAGE CONTENTS

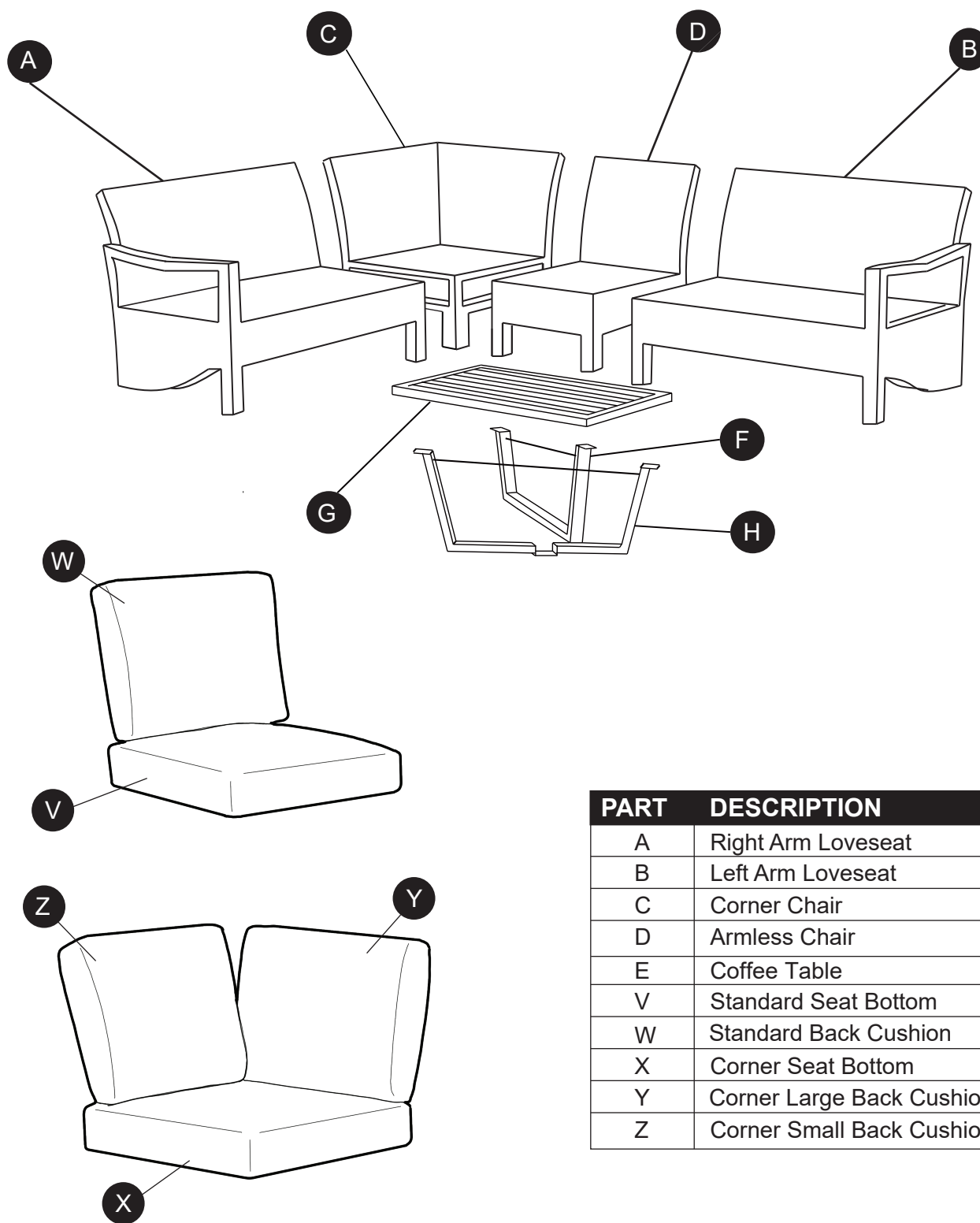

PART	DESCRIPTION	QTY
A	Right Arm Loveseat	1
B	Left Arm Loveseat	1
C	Corner Chair	1
D	Armless Chair	1
E	Coffee Table	1
V	Standard Seat Bottom	5
W	Standard Back Cushion	5
X	Corner Seat Bottom	1
Y	Corner Large Back Cushion	1
Z	Corner Small Back Cushion	1

Note: You will also have 6 plastic bags containing your fabric covers.

5 Bags: Standard Seat Covers (1 bag contains both 1 bottom seat and 1 back cover)

1 Bag: Corner Seat Covers (1 bag contains 3 covers: 1 bottom and 2 back covers)

HARDWARE CONTENTS

AA



M6 Bolt x 20mm
Qty: 9

BB

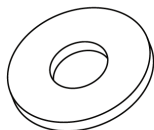

Washer
Qty:9

CC



Plastic Bolt Cap
Qty:9

DD

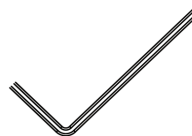

Allen Key
Qty: 1

EE

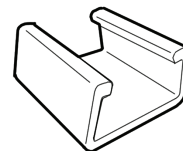

Chair Clips
Qty: 3

SAFETY INFORMATION

Please read and understand this entire manual before attempting to assemble, operate or install the product.

 **CAUTION:** Assemble on a soft, non-abrasive surface.

PREPARATION

Before beginning assembly of product, make sure all parts are present. Compare parts with the package contents list and hardware contents list. If any part is missing or damaged, do not attempt to assemble the product.

If you find a missing or damaged part, please look through all pieces to make sure nothing else is missing or damaged. Compile a comprehensive list and give us a call. We will send out all parts in a single shipment. Ensuring you have all missing parts identified at the time you call will ensure a faster delivery to complete your beautiful patio furniture.

CUSHION ASSEMBLY

Before beginning, make sure all cushions and covers are present. The differences between the standard cushions and the corner cushion is very subtle, so make sure you have identified the difference in size before pulling on the fabric covers.

NOTE: Do not remove covers from plastic bags until you have paired them with the matching (V, W, X, Y, Z) cushion. Match the letters on the cushion with the same letters on the fabric bags.

PART	DESCRIPTION	QTY
V	Standard Seat Bottom	5
W	Standard Back Cushion	5
X	Corner Seat Bottom	1
Y	Corner Large Back Cushion	1
Z	Corner Small Back Cushion	1

STANDARD CUSHION

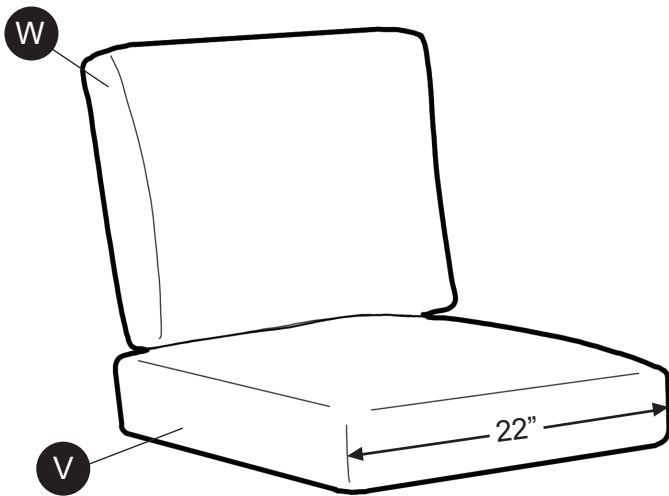

CORNER CUSHION

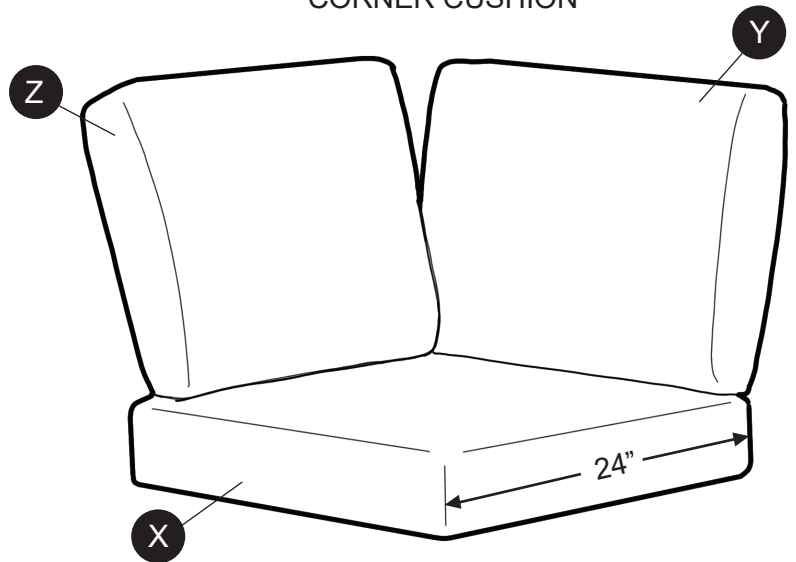

HELPFUL TIP: we call this the 'Taco Method'. Place the cushion between your knees and squeeze together to form a taco. This makes it much easier to pull on the cushion cover.

ASSEMBLY INSTRUCTIONS

1. Push all chair pieces together in your chosen configuration. Lean the furniture back and attach clips to the underside of the frames to hold each chair together. This will keep the chairs from moving during use. 1 clip per gap.

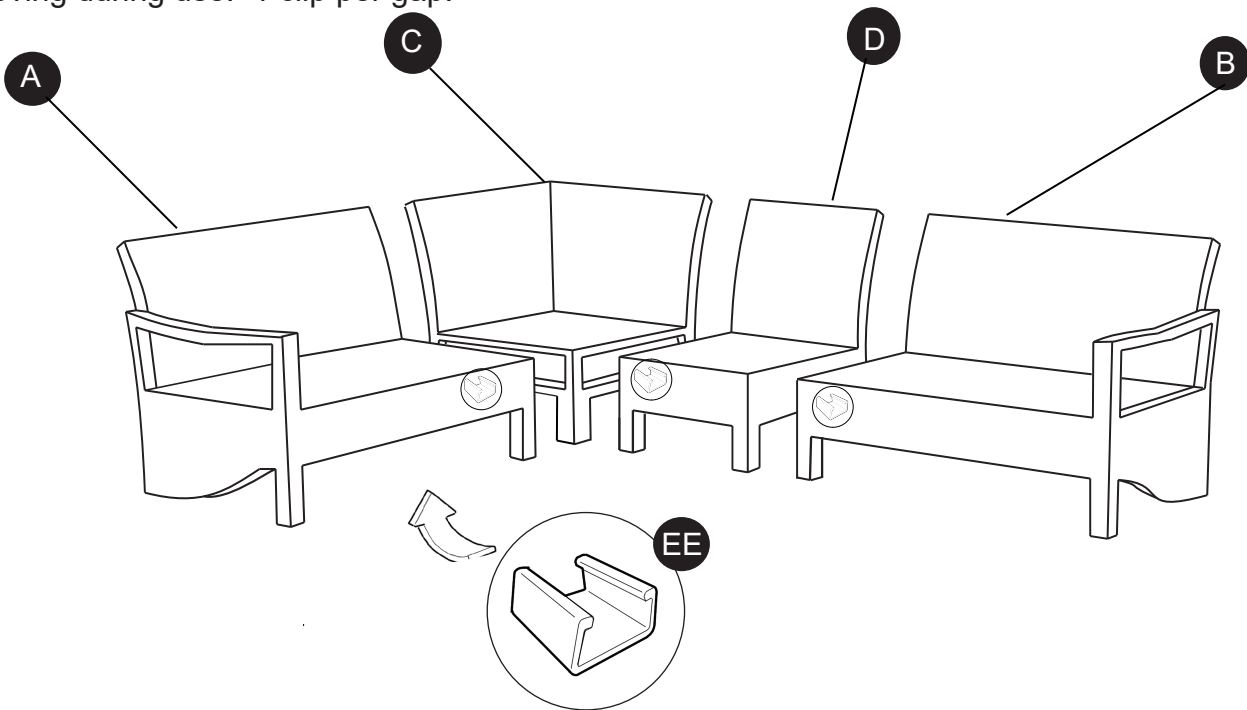

2. With all the furniture secured with clips, now add your finished corner cushions (these are the cushions that are slightly different in size than the standard seat cushion). Then add all additional cushions.

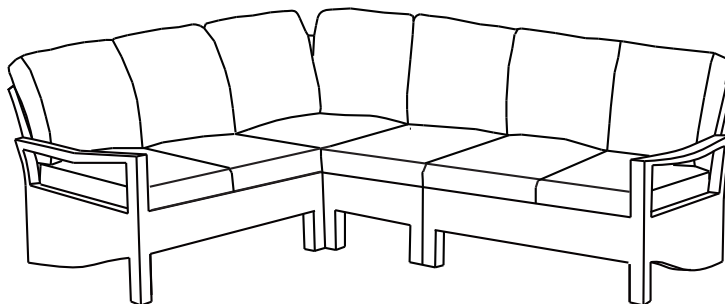
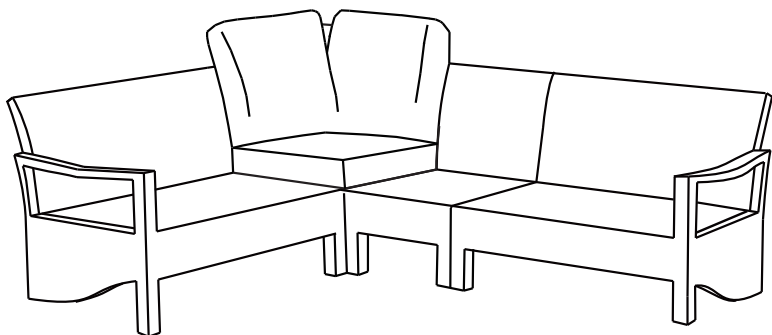

ASSEMBLY INSTRUCTIONS

3. Attach table legs (B) & (C) together with bolts (AA) and washers (BB) using the allen key (DD).

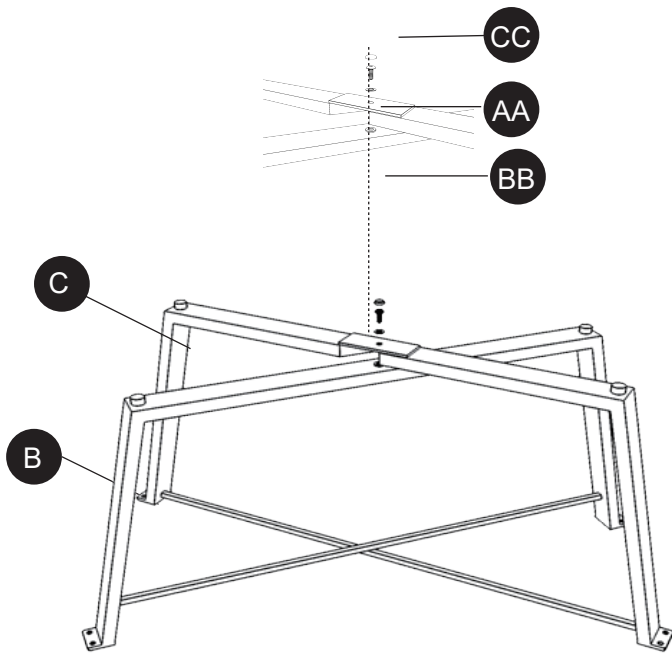

4. Place table top (A) face down on a soft surface and fasten the legs (B) & (C) to the top with bolts (AA) and washers (BB) using the allen key (DD).

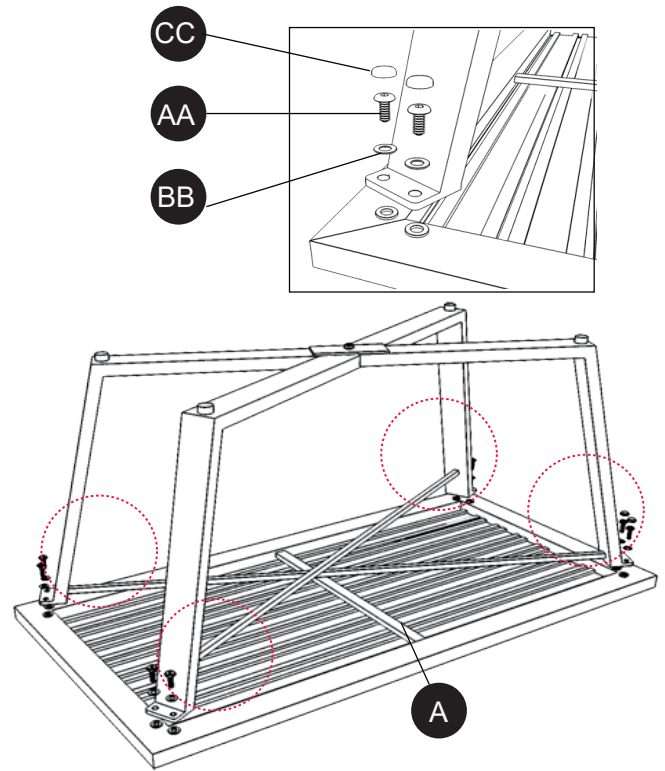

5. Flip coffee table over and enjoy your beautiful furniture!

